

18.00 TABLE OF CONTENTS AND PULL-OUT PAGE

GENERAL

18.10 SYSTEM OVERVIEW

SYSTEM ARCHITECTURE

18.20 COMPONENTS DESCRIPTION AND SCHEMATICS

WARNINGS

18.30 OPERATIONAL DESCRIPTION

SYSTEM INTERFACE

18.40 CONTROLS AND DISPLAYS

NORMAL FLIGHT CONDITIONS

18.50 FLIGHT PHASE RELATED MODE

ADVISORY MODE

18.60 ADVISORY CONCEPT

ABNORMAL FLIGHT CONDITIONS

18.70 HANDLING OF ECAM WARNINGS

18.71 INDEPENDENT FAILURES

18.72 PRIMARY/SECONDARY FAILURES

LOSS OF ECAM COMPONENTS

18.80 OPERATION WITH ECAM PARTIALLY OR TOTALLY INOPERATIVE

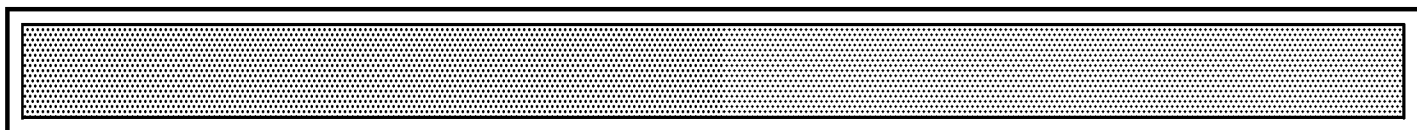

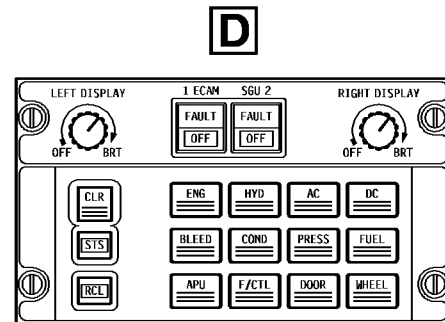
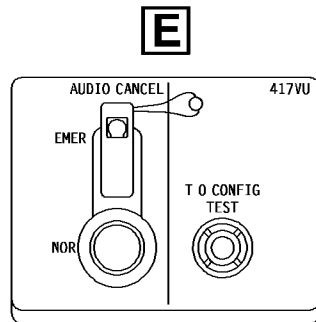
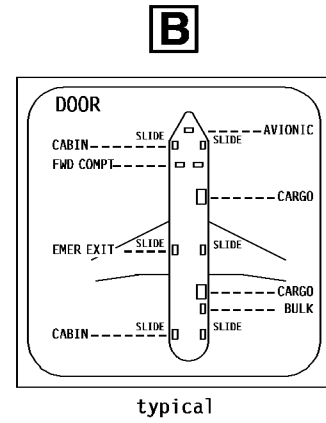
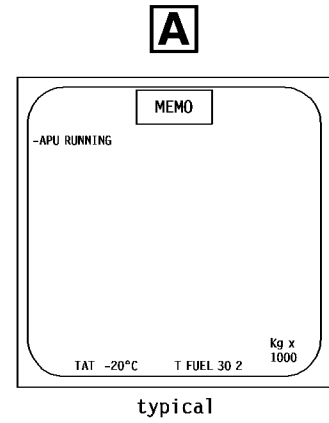
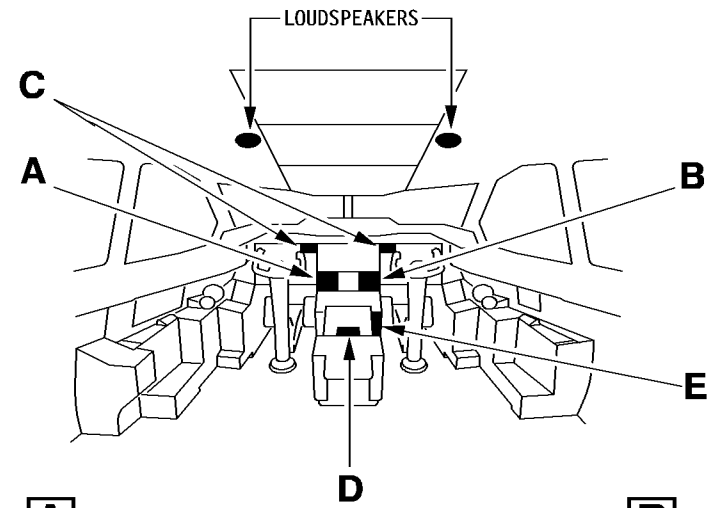

←
**MAIN
SYSTEM CONTROLS
AND DISPLAYS**

R

80FC-01-1800-002-410044

Mod : 5051

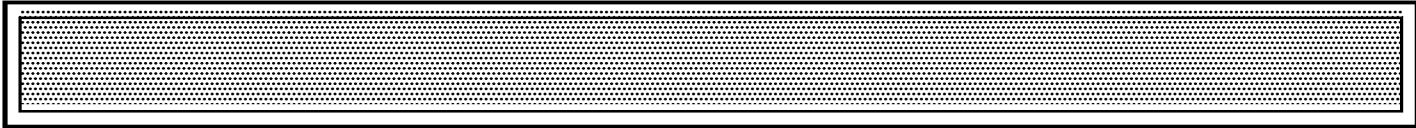

GENERAL

- The Electronic Centralized Aircraft Monitor (ECAM) provides :
 - Audio warnings for failures and other conditions requiring crew action/attention.
 - Automatic analysis of aircraft systems failures and required procedures.
 - Systems information and procedures on two display units.
- The ECAM minimizes the need for the crew to frequently scan the system panels :
 - Monitoring of temporarily used items is performed on the MEMO page.
 - Routine system monitoring is performed by checking the System Display (system pages).
 A system page is available for each of the main aircraft systems. The most suitable system page for the actual flight phase is automatically displayed.
 - The ECAM constantly monitors system parameters to provide early notification to the crew if any monitored parameter drifts out of its normal range (Advisory mode).
- Processing of aircraft systems data by the ECAM system is fully automatic.

ECAM DISPLAYS

- The ECAM interfaces with the flight crew via the following procedure-related and system-related pages :

– **MEMO page :**

The MEMO page recalls the list of systems which are selected for temporary use.

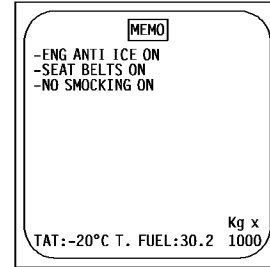

80FC-01-1810-001-A001A4

R

– **Warning page :**

The warning page displays the list of required actions and information related to system failures :

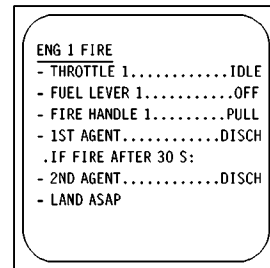

80FC-01-1810-001-8001A4

– **STATUS page :**

The STATUS page provides additional information, cross-reference to the QRH procedures and systems status reminder :

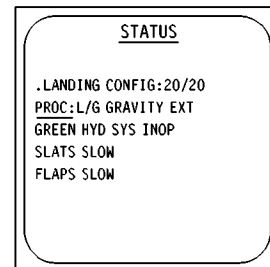

80FC-01-1810-001-C001A4

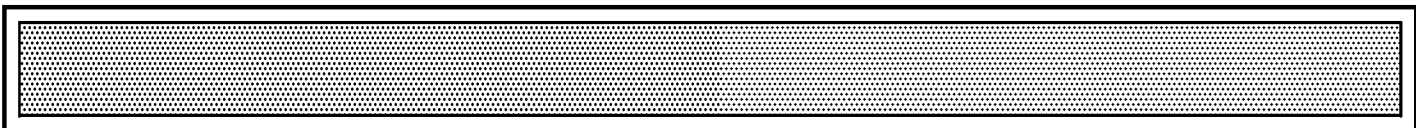

– **System page :**

R

System pages provide schematics of each of the major aircraft systems. System pages are displayed automatically or can be manually selected :

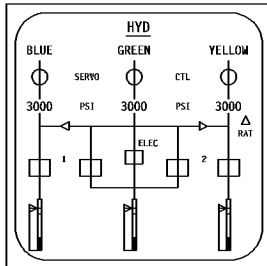

80FC-01-1810-002-A001AB

FLIGHT WARNING COMPUTERS (FWC)

- The ECAM system is driven by two Flight Warning Computers (FWC).
 Each FWC acquires and processes the aircraft systems data and generates the warning indications and system status data.
- The two FWC also activates :
 - Audio warnings,
 - The MASTER CAUTION and MASTER WARNING lights,
 - The stick shaker,
 - Autoflight System warnings.
- Each FWC has the capability to acquire
 - 100 % of the red warnings (emergency conditions),
 - 50 % of the amber cautions (abnormal conditions).

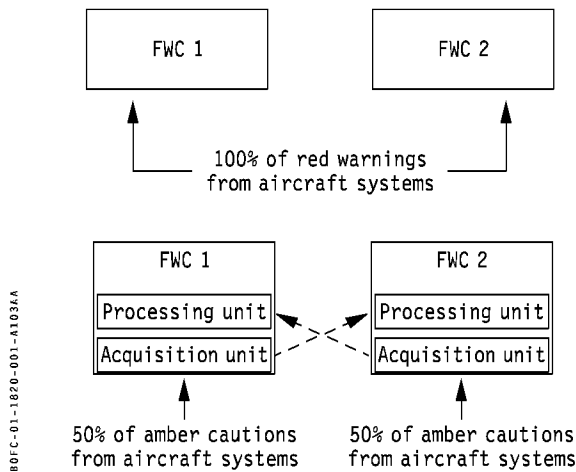

- A cross-talk data bus enables each FWC to process the 50 % amber cautions acquired by the second FWC.
- The loss of one FWC :
 - does not affect the red warnings,
 - affects part of the amber cautions (local warning lights, as applicable, are not affected).

Mod : 5051

ECAM SYMBOL GENERATOR UNITS (SGU)

- 2 Symbol Generator Units (SGU) process the output data from the FWC, System Data Analog/Digital Converter (SDAC), ADC and Fuel Quantity Indication System (FQI) for presentation on ECAM.
 The SGU'S also process the output data of optional equipment (as applicable) for display of the related information on ECAM.
- SGU 1 drives the left CRT and SGU 2 drives the right CRT :

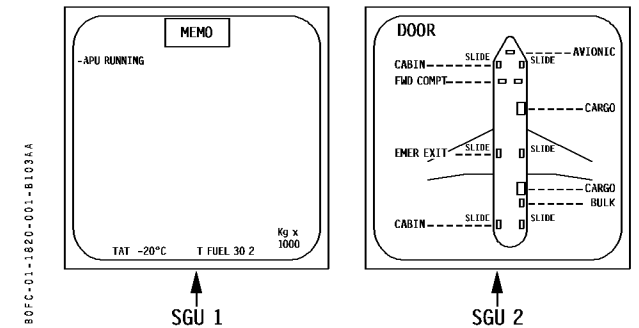

SYSTEM DATA ANALOG-TO-DIGITAL CONVERTER (SDAC)

- The SDAC converts analog aircraft sensor data to the digital format required by the two FWC and other onboard computers.

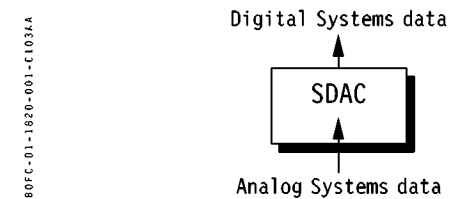

- The SDAC provides digital information for the system pages, action feedback for the warning pages, and information for the MEMO page.

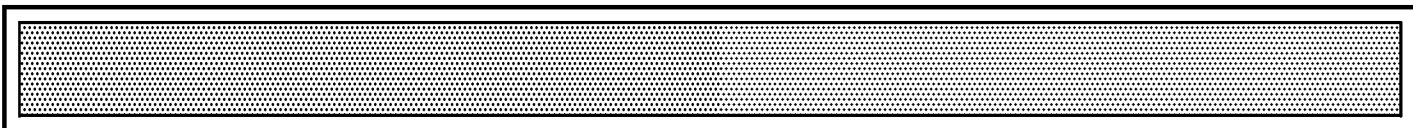

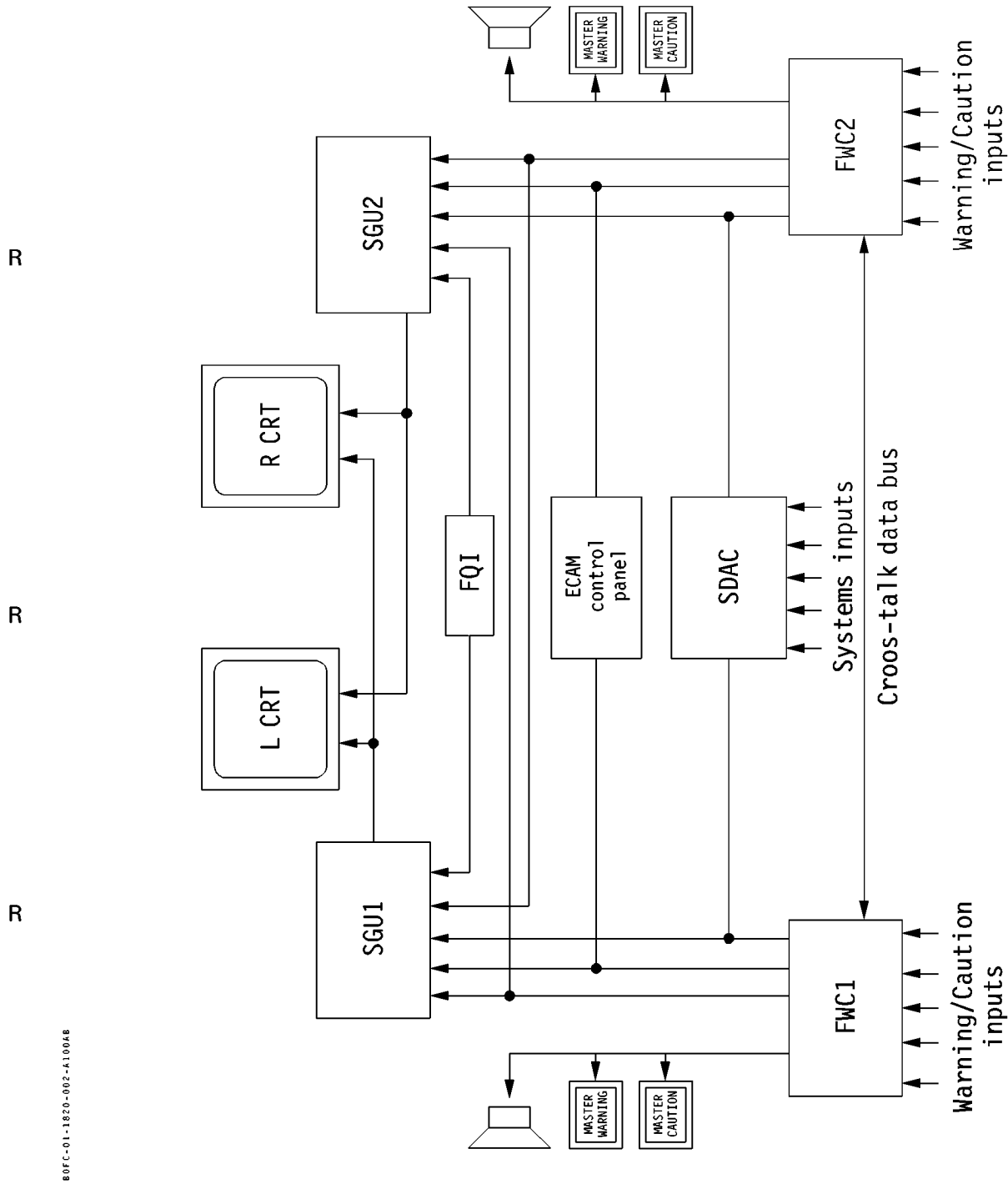

80FC-01-1820-002-A10048

Mod : 5051

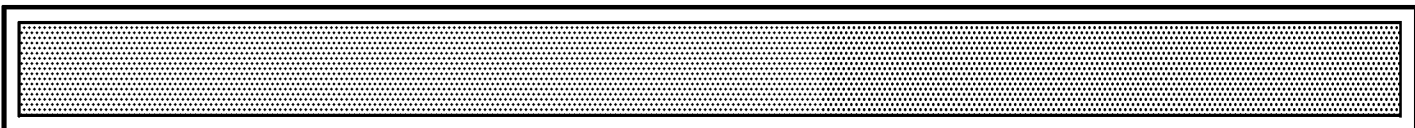

WARNING LEVELS

- ECAM messages are divided into four levels, as follows :

RED WARNINGS

- Red warnings are associated with emergency conditions, and are identified by a red local warning light and by a Continuous Repetitive Chime (CRC), or other specific audio warnings.
- Immediate crew action must be initiated.

AMBER CAUTIONS

- Amber cautions are associated with abnormal conditions, and are identified by an amber warning light and a Single Chime (SC) audio warning.
- Immediate crew action is not required. However, time and situation permitting, these cautions should be considered without delay to prevent any further degradation of the affected system.

R
R
R
R

AMBER ALERTS

- Amber alerts correspond to conditions which only require crew monitoring, and are identified by an amber local warning light with no audio alert.
- Amber alerts are provided primarily for failures which cause the loss of system redundancy.

INFORMATION

- Additional information is provided in blue, green or white.

PRIORITY RULES

- Red Warnings have priority over Amber Cautions, which in turn have priority over Amber Alerts.
- Messages are ranked by importance so that, if more than one malfunction occur at the same time, the most important information is presented first.

PRIMARY FAILURES

- A **primary failure** is an equipment failure which results in the loss of one or more additional equipment or system.

For example, the loss of ADC 1 is a **primary failure**, resulting in the loss of :

- PITCH TRIM 1,
- YAW DAMPER 1,
- AP 1,
- ADC information on captain’s instruments.

SECONDARY FAILURES

- **Secondary failures** are caused by **primary failures**.
- In the above example, the loss of PITCH TRIM 1, YAW DAMPER 1, AP 1, and of ADC information on the captain’s instruments are secondary failures caused by the primary failure of the ADC 1.

INDEPENDENT FAILURES

- An independent failure affects an isolated piece of equipment or system without affecting other equipment (e.g. : a fuel TK PUMP LO PR alone).

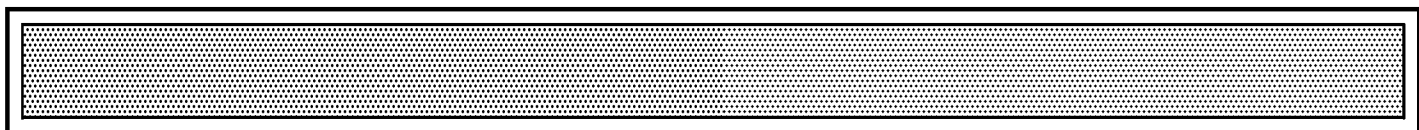

ECAM CRT COLOR CODES

- The following colors are used on the ECAM CRTs :

Color	Left CRT	Right CRT
Red (R)	<ul style="list-style-type: none"> • Emergency 	<ul style="list-style-type: none"> • Emergency
Amber (A)	<ul style="list-style-type: none"> • Anormals • No action feedback 	<ul style="list-style-type: none"> • Abnormals • "XX" Flags
Cyan (B) (Blue)	<ul style="list-style-type: none"> • Actions to be taken by crew • Limitations to be applied by crew (Speed increments, Landing Distance factors) • QRH procedures to be applied, in addition to ECAM actions. crew 	<ul style="list-style-type: none"> • Units (°C, PSI, ...)
White(W)	<ul style="list-style-type: none"> • Actions completed (<i>action feedback</i>) 	<ul style="list-style-type: none"> • Titles of manually selected system pages • ADV (advisories) • General inscriptions
Green (G)	General Information	<ul style="list-style-type: none"> • System parameters in normal ranges
Magenta(M) (Purple)	On MEMO page : <ul style="list-style-type: none"> • TO or LDG INHIB message • STATUS message 	<ul style="list-style-type: none"> • Not Used

COCKPIT PANEL LIGHTS

LOCAL WARNINGS

- The annunciator lights on the cockpit systems panels are called **local indications** or **local warning lights**.

- Local warning lights provide independent indications of system failures/faults.

Local warning lights are activated directly by the affected equipment and remain available when the associated ECAM warning is inhibited or if the ECAM system is partially or totally inoperative.

LIGHTS OUT CONCEPT

- In normal, operation, all local indication lights are extinguished except green flowbars and digital fuel quantity indications.

- The following colors are used for the cockpit annunciator lights :

	COLOR	MEANING	
WARNING	Red	Emergency condition requiring immediate crew action	R R
CAUTION	Amber	Abnormal condition not requiring immediate crew action.	R
INFORMATION	Green	Normal system operation	
	Blue	Normal but temporary use of a system (e.g. : APU AVAIL)	
	White	Switch is not in normal position (e.g. OFF, ALTN)	

Mod : 5051

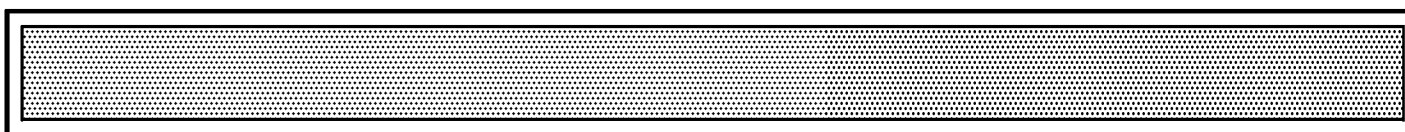

ECAM WARNINGS INHIBITION

- To prevent the activation of ECAM warnings during critical flight phases (unless otherwise warranted), most ECAM warnings are inhibited :
 - during takeoff and landing,
 - in accordance with a flight-phase-related inhibition, defined for each individual warning (refer to the ECAM WARNING LOGIC page of each individual system description).
- The following ECAM warnings are never inhibited :
 - Engine or APU fire,
 - Engine failure,

- The warning inhibition can be cancelled by pressing the RCL pushbutton on the ECAM Control Panel. This enables the ECAM warning pages and audio warnings to be available.
- When TO or LDG INHIB (inhibition) is active, if a warning is still being inhibited 60 seconds after the malfunction occurred, the warning inhibition is automatically cancelled.

R

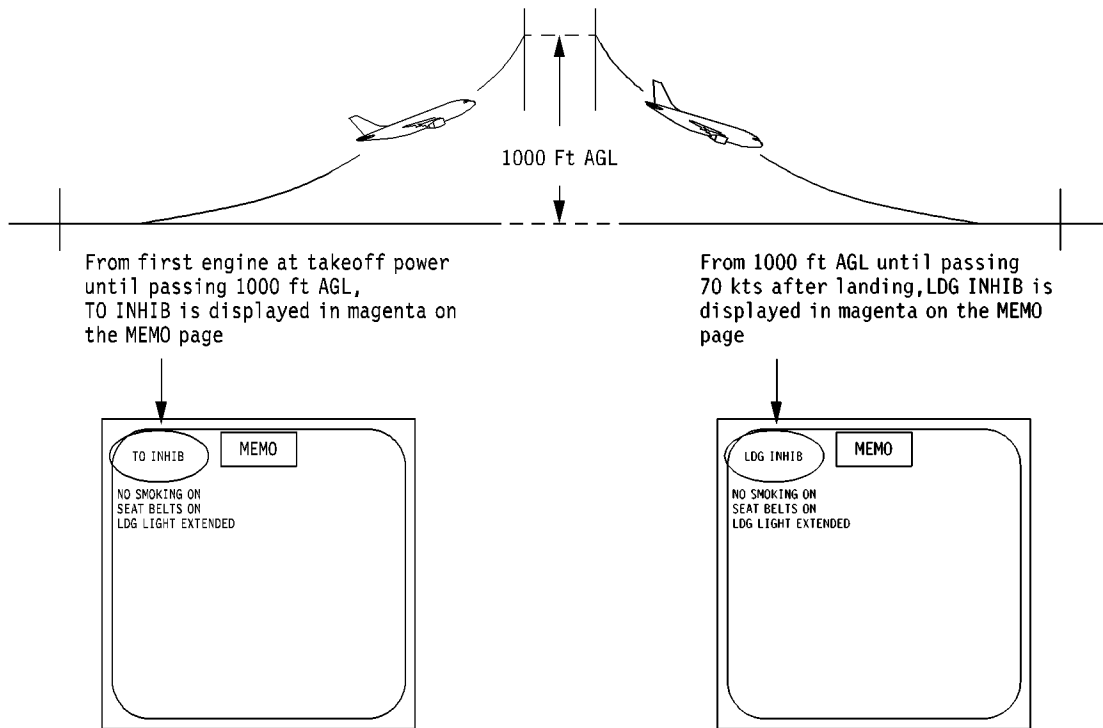

80FC-01-1830-003-4001A6

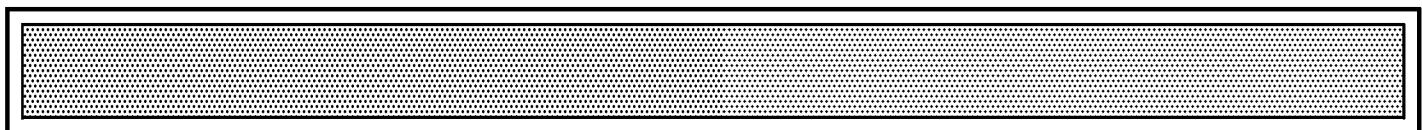

- The following typical flight profile identifies 12 flight phases used to define the flight-phase-related inhibition of ECAM warnings.

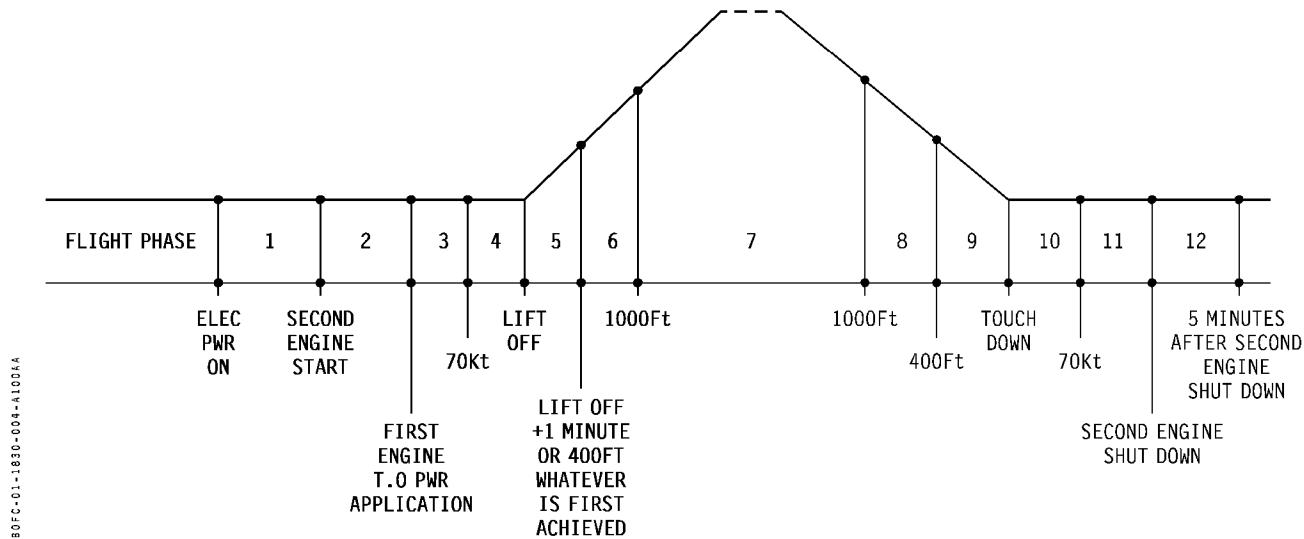

Mod : 6269

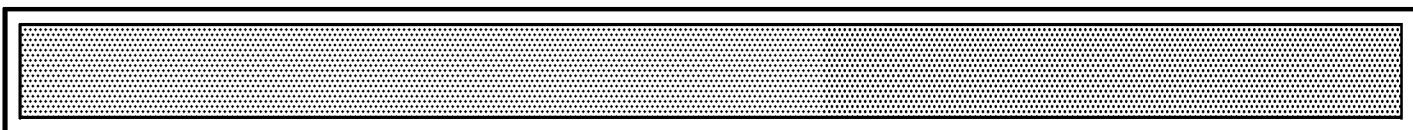

ECAM WARNING OR CAUTION PRESENTATION

• When a system malfunction is detected by one FWC, the ECAM system simultaneously generates three types of warnings :

– **Audio warning :**

An audio alert sounds in the cockpit loudspeakers to attract the flight crew’s attention :

- Single Chime (SC) for abnormal conditions (cautions),
- Continuous Repetitive Chime (CRC) for emergency conditions (warnings).

R *Note :* For amber alerts which only results in the loss of system redundancy (e.g. : loss of only one Pitch Trim system) no audio warning is generated.

– **MASTER WARNING and MASTER CAUTION lights :**

• The relevant light illuminates to provide visual confirmation of the abnormal or emergency condition.

– **CRT information :**

• Required ECAM actions, ranked by priority, and STATUS information are displayed on the left hand CRT :

• System pages associated with the warning pages are displayed on the right hand CRT.

Note : The system page must should be checked to confirm that the warning is correct and, after completion of ECAM actions, to review the resulting system condition.

Note : Warning and Caution presentations have priority over all other CRT displays. However, after the Warning or Caution is displayed, any system page can be manually selected.

SUMMARY

	Type of Warning	Where
1	Audio alert : <ul style="list-style-type: none"> • CRC for Emergencies (red warnings) • Single Chime for Cautions (amber cautions) 	Cockpit Loudspeakers
2	CRT Information : <ul style="list-style-type: none"> • Warning and STATUS pages • Affected System pages 	LH ECAM CRT RH ECAM CRT
3	Visual alerts	MASTER WARNING and MASTER CAUTION lights

R

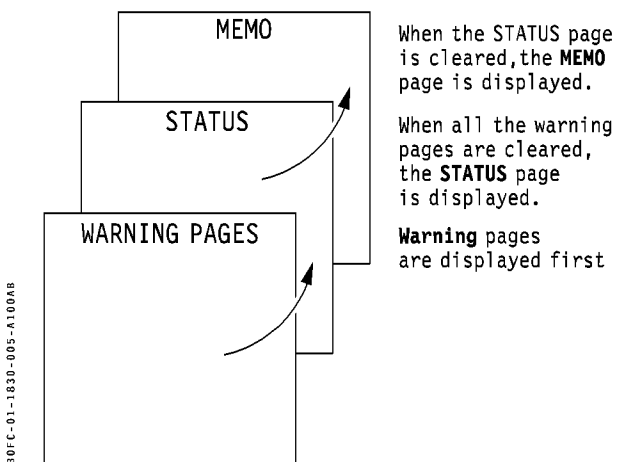

WARNING PAGES

• **General :**

– The title of a warning page is consistent with the title of the associated Quick Reference Handbook (QRH) section where the QRH procedure is located.

Note : If the warning page displays a "HYD" procedure, refer to in the "HYD" section of the QRH to review the associated QRH procedure.

– Wording and abbreviations used on warning pages are consistent with the overhead panel.

Mod : 5051

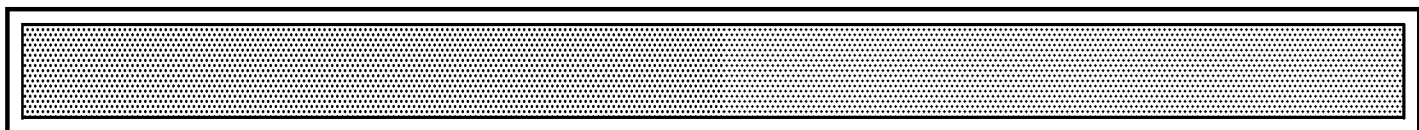

ECAM
WARNINGS
 OPERATIONAL DESCRIPTION

1.18.30	
PAGE 6	
REV 36	SEQ 001

CREW COORDINATION

- R
- When all ECAM actions under a particular warning page title are completed, the CLR pushbutton must be pressed but, only after cross-checking with the PF (refer to the introductions of FCOM chapters 2.04.10 – Emergency procedures – and 2.05.10 – Abnormal procedures – for crew coordination procedures).

USE OF QUICK REFERENCE HANDBOOK (QRH) PROCEDURES

- Refer to QRH 0.01 and 0.02. R

ADDITIONAL WARNING PAGES

- After the first warning page has been cleared, the subsequent pages display the procedures related to additional failures, if any.
- If a warning is cleared while being displayed, the associated warning page is also cleared (e.g. if an ENGINE FIRE warning is cleared by setting the throttle lever to idle, the ENGINE FIRE warning page is cleared from the LH CRT).

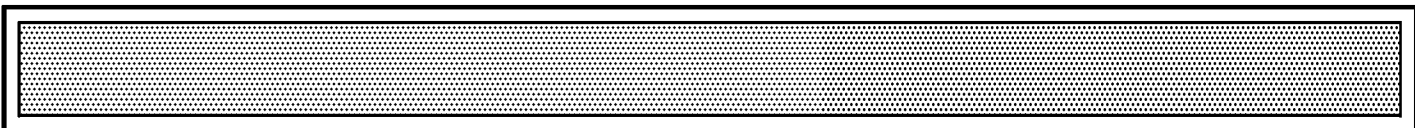

T.O. CONFIGURATION TEST AND T.O. WARNING

- Refer to the section 1.09.50 for detailed description of the T.O. CONFIG test and T.O. warning.

AUDIO WARNINGS

- Several types of audio warnings are provided :

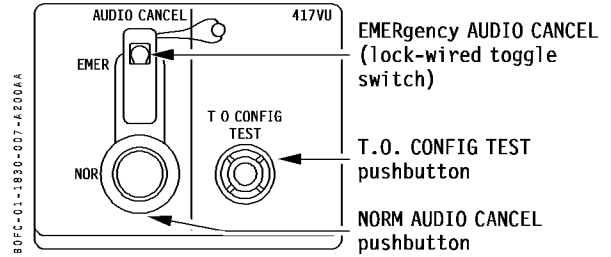

AUDIO WARNING	ACTIVATED BY :	CANCELLED BY :
Single Chime (SC)	<ul style="list-style-type: none"> • Amber cautions 	<ul style="list-style-type: none"> • No cancel required
Continuous Repetitive Chime (CRC)	<ul style="list-style-type: none"> • Red warnings • Engine/APU Fire • Cargo/Electrical Smoke • Gear Not Down : <ul style="list-style-type: none"> * During Approach * During Landing • TO Configuration • Overspeed • Excess AFT CG 	<ul style="list-style-type: none"> • NORM audio cancel pushbutton • NORM audio cancel pushbutton or pulling associated FIRE handle • NORM audio cancel pushbutton <ul style="list-style-type: none"> * NORM audio cancel pushbutton * Corrective action or EMER audio cancel • Corrective action or EMER audio cancel • Corrective action or EMER audio cancel • Corrective action or EMER audio cancel
Stick Shaker/"Cricket"	<ul style="list-style-type: none"> • Stall Warning 	<ul style="list-style-type: none"> • Corrective action or EMER audio cancel
"C" Chord	<ul style="list-style-type: none"> • Altitude Alert 	<ul style="list-style-type: none"> • Corrective action or EMER audio cancel
"Whooler"	<ul style="list-style-type: none"> • THS moving (<i>only with AP not in CMD</i>) 	<ul style="list-style-type: none"> • Stopping pitch trim input
Triple "Click"	<ul style="list-style-type: none"> • Change of Landing Capability Category 	<ul style="list-style-type: none"> • No cancel required
Tea Kettle (or Auto Callouts)	<ul style="list-style-type: none"> • Decision Height 	<ul style="list-style-type: none"> • NORM audio cancel push-button or auto
Cavalry Charge (<i>every 3 seconds till cancelled</i>)	<ul style="list-style-type: none"> • Autopilot Disconnect 	<ul style="list-style-type: none"> • Pressing AP instinctive disconnect push-button at least 1 second.
Selcal buzzer (<i>On 1 sec, Off 1 sec ...</i>)	<ul style="list-style-type: none"> • Selective Calling alert 	<ul style="list-style-type: none"> • NORM audio cancel pushbutton
Continuous buzzer	<ul style="list-style-type: none"> • Cabin Call 	<ul style="list-style-type: none"> • No cancel required

Mod : 4801 + 5051

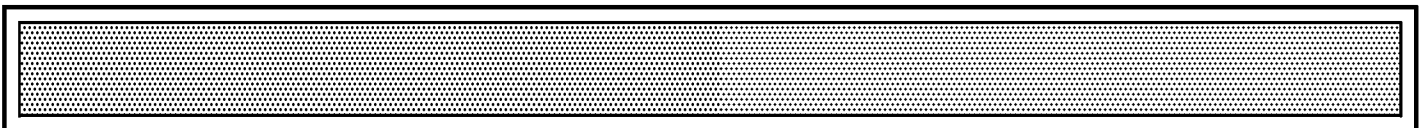

WARNING LOGIC

- The following schematics provides a typical warning logic, as illustrated in the description of each individual system.

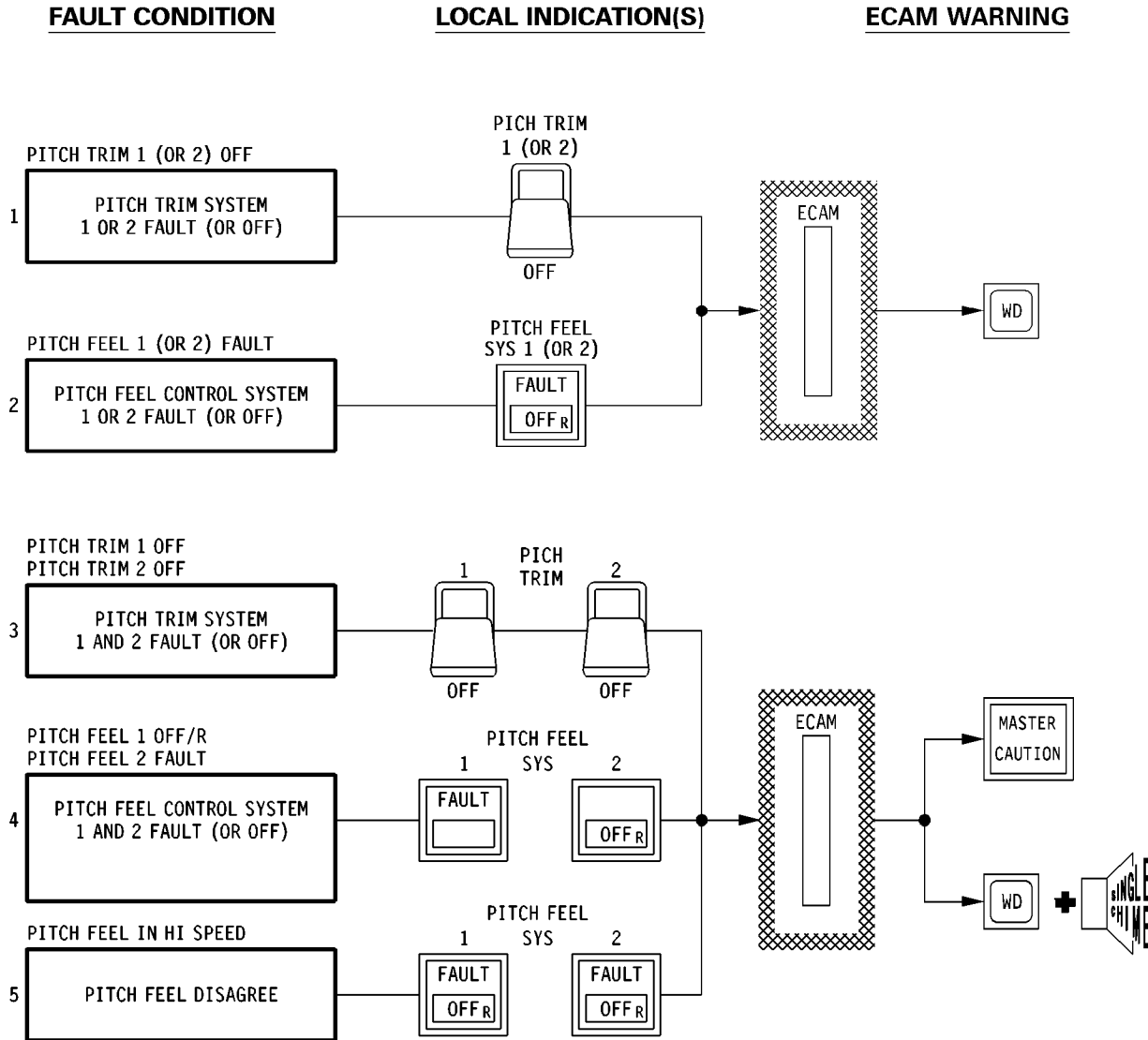

ECAM AUTOMATIC FLIGHT PHASE INHIBITION

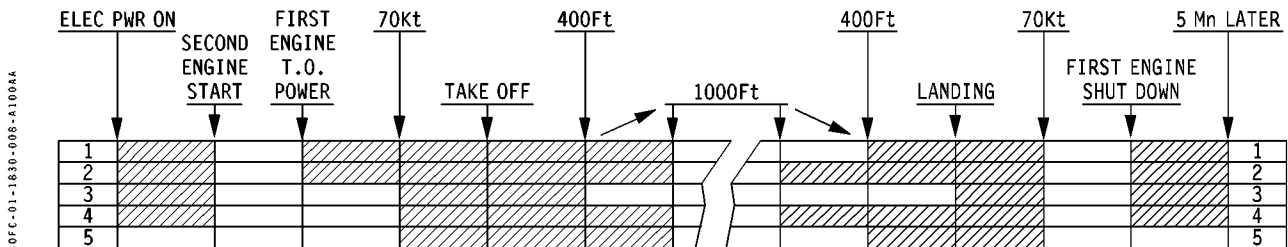

Mod : 5051

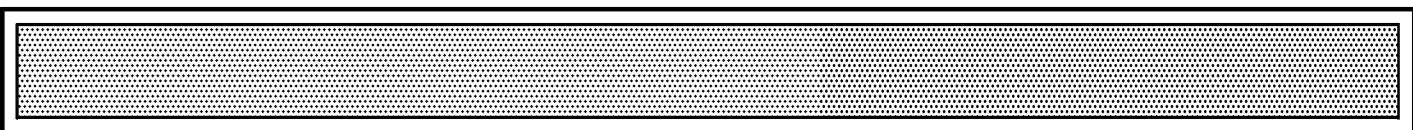

ECAM DISPLAY UNITS (CRTs)

LEFT CRT

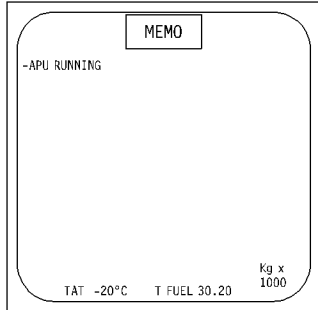

RIGHT CRT

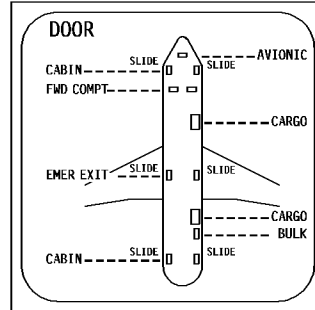

- The left CRT displays :
 - Red/Amber warning pages, or
 - The STATUS or MEMO page.

- The right CRT displays system pages.

MASTER LIGHTS

80FC-01-1840-01-1100AA



(1) Red Warning flashing light (pushbutton)

- Require immediate crew action.
- In the event of a red warning, pressing the MASTER WARNING light extinguishes both MASTER WARNING lights and cancels the aural warning. This action has no effect on CRT messages.

(2) Amber Warning lights (pushbutton)

- Action may be delayed, as required.
- In the even of an amber caution pressing either MASTER CAUTION light extinguishes both MASTER CAUTION lights and cancels the aural warning. This action has no effect on CRT messages.

Mod : 5051

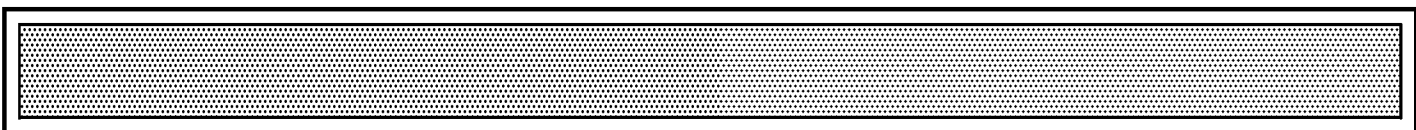

ECAM CONTROL PANEL

- The ECAM control panel enables the crew to :
 - Switch ECAM CRTs on or OFF and to adjust the ECAM CRT brightness,
 - Manually select system pages,
 - Manually select the STATUS page,
 - Clear warning pages with the CLR push-button,
 - Review the completed warning pages using the RCL (Recall) push-button,
 - Switch the Symbol Generator Units (SGUs) On or OFF.

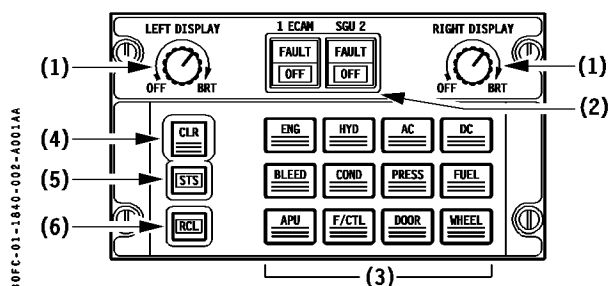

(1) Brightness adjustment knobs

- Used to switch On/OFF and adjust the brightness of each CRT display.

(2) Symbol Generator Unit (SGU) pushbutton

- Amber FAULT light illuminates if an SGU failure is detected.
- Pressing the affected push-button turns off the associated SGU. FAULT extinguishes and the white OFF light illuminates.
- Both CRT's are then driven by the remaining SGU.

(3) System pages selection keys

- Pressed to manually select a system page for review on the right CRT.
When a key is pressed, the key illuminates white.
- A manually selected system page can be deselected by pressing its illuminated pushbutton a second time.

- In single CRT mode (i.e. with one CRT failed), system pages can only be manually selected when the MEMO page is displayed. (All warning pages and the STATUS page must have been cleared first).
- If a warning or advisory occurs, the associated system page automatically replaces any manually selected page.

(4) CLR (Clear) pushbutton

- Illuminates white when a warning page or the STATUS page is displayed.
- Each press clears one warning page or the STATUS page from the display.
- Extinguishes when the MEMO page is displayed (No more warning pages or STATUS pages remaining).

(5) STS (Status) pushbutton

- When the MEMO page is displayed, pressing the STS pushbutton enables to manually select the STATUS page.
- If the STS pushbutton is pressed when no STATUS message exists, a STATUS NORMAL message is displayed.
- STATUS messages are not automatically displayed before the second engine start or after the first engine shutdown.
- If a warning occurs while the STATUS page is displayed, the applicable warning page replaces the STATUS page.

(6) RCL (Recall) pushbutton warning

- Pressing this pushbutton displays, in sequence, all the warning pages that have been cleared.
- If the RCL pushbutton is pressed when no failures exist, a NORMAL message appears.
- Pressing the RCL pushbutton also cancels the ECAM warning inhibition until the end of the present flight phase.

This enables the ECAM to activate visual and audio warnings for malfunctions which are inhibited in the present phase of flight.

AUDIO CANCEL PANEL

- An audio interface provides audio alerts through the aircraft loudspeakers.
- Audio warnings can be cancelled using :
 - The NORM audio cancel pushbutton,
 - or
 - The safety-wired EMER audio cancel switch.

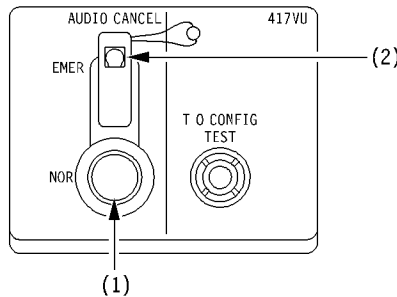

BOFC-01-1840-003-A100A4

(1) NORM AUDIO CANCEL Pushbutton

Pressing the NORM AUDIO CANCEL pushbutton cancels all audio warnings, except the following :

- LANDING GEAR NOT DOWN
- TO. CONFIG
- OVERSPEED
- STALL
- TCAS

- R
- GPWS or EGPWS
 - STAB IN MOTION
 - ALTITUDE ALERT

Note : These audio warnings can only be cancelled by use of the EMER AUDIO CANCEL switch.

Mod : 5051

(2) EMER AUDIO CANCEL WARNING SYS pushbutton

- This safety wired and guarded switch can be used to cancel all audio red warnings which cannot be canceled using the NORM CANCEL pushbutton and which produce an operational nuisance. R
- When EMER AUDIO CANCEL function has been used, the related red aural warning inhibition is automatically canceled when related warning failure condition disappears. Then if same warning activation conditions reappears, the red aural warning is triggered again.
- The EMER CANCEL ON message appears on ECAM when EMER AUDIO CANCEL switch is used and no ECAM warning activated.

CAUTION

If a failure occurs while the Emer Cancel push button is depressed, the associated audio warning (red warning) or the associated audio warning and ECAM warning (amber warning) will not be triggered.

- ECAM messages are displayed to indicate that the specific warning which has been cancelled, (e.g. APU FIRE WARNING CANCELLED).
- Cancellation can be removed by pressing the RCL pushbutton on the ECAM control panel for more than 3 seconds.
- Cancellation is automatically reset when the electric power is initially applied to the aircraft, or after the first engine shutdown.

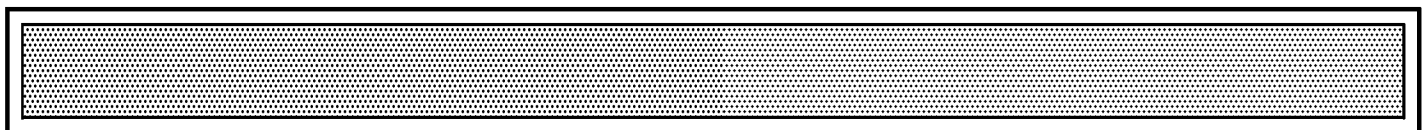

MANUAL SELECTION OF SYSTEM PAGES :

- Any system page (except the CRUISE page) can be displayed on the right CRT by pressing the associated key on the ECAM control panel.

The selected key illuminates.

- If an advisory or system failure occurs when a system page is manually displayed, the page related to the system affected by the advisory or failure automatically replaces the selected system page.

SYSTEM DISPLAY

- The selected system page is displayed on the right ECAM CRT.

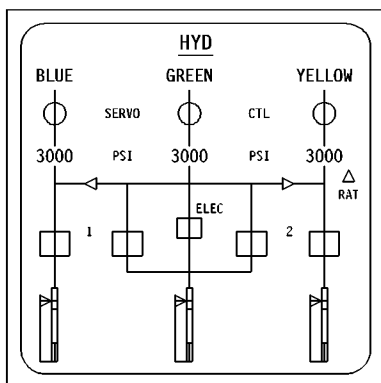

80FC-01-1840-004-A001AA

SYSTEM PAGES

- The following system pages can be selected by pressing the corresponding key on the ECAM control panel :

Key	Page Title	Description
ENG	ENGINE	Engine secondary parameters
HYD	HYD	Hydraulic power generation and distribution
AC	ELEC-AC	AC electrical power generation and distribution
DC	ELEC-DC	DC electrical power generation and distribution
BLEED	AIR BLEED	Bleed valves and air conditioning packs parameter
COND	AIR COND	Valves positions, ducts and compartments temperatures
PRESS	CAB PRESS	Valves positions, cabin differential pressure, vertical speed and altitude
FUEL	FUEL	Fuel pumps, feed lines and valves status
APU	APU	APU, APU GEN and APU BLEED parameters
F/CTL	FLT CTL	Flight controls hydraulic supply and position
DOOR	DOOR	Doors and slides status
WHEEL	WHEEL	Brakes and ground spoilers information

- The following flight phase related system page is also available :

– ENG START :

- The ENG START is similar to the ENG page, but the lower left indicating scale is replaced by a BLEED pressure indication.



SYSTEM DISPLAY INDICATIONS

- When in their normal ranges all digital values and analog indications are green. When an indication reaches its warning level, the associated analog pointer and digital value become amber (abnormals) or red (emergencies).
- In case of loss of sensor electrical power or loss of signal, the associated indication is replaced by an amber "XX".

Note 1 : All units (e.g. : °C, PSI, V, Hz, etc...) are displayed in cyan.

Note 2 : System page titles :

When a system page is displayed automatically (except by advisories) the page title is green.

If a system page is manually selected, or displayed by an advisory, its title is white.

PUMP and VALVE SYMBOLS

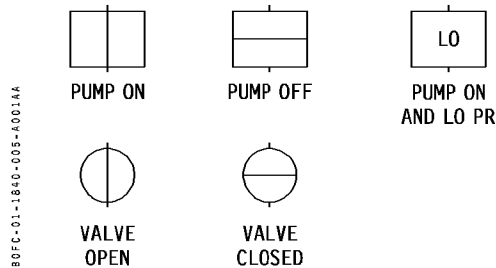

SYSTEM PAGE COLOR CODING

CONDITION	COLOR USED
In use	Green
Unusable	Amber
Not in use	Not shown
Off	White
Normal	Green
Abnormal	Amber
Emergency	Red

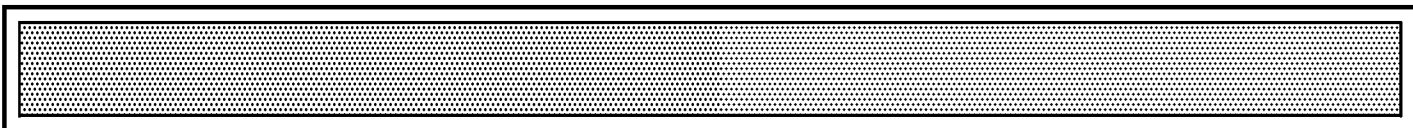

CRUISE PAGE

- The CRUISE page is automatically displayed when in clean configuration or when both throttle levers are retarded below takeoff power, if no other system page is displayed.

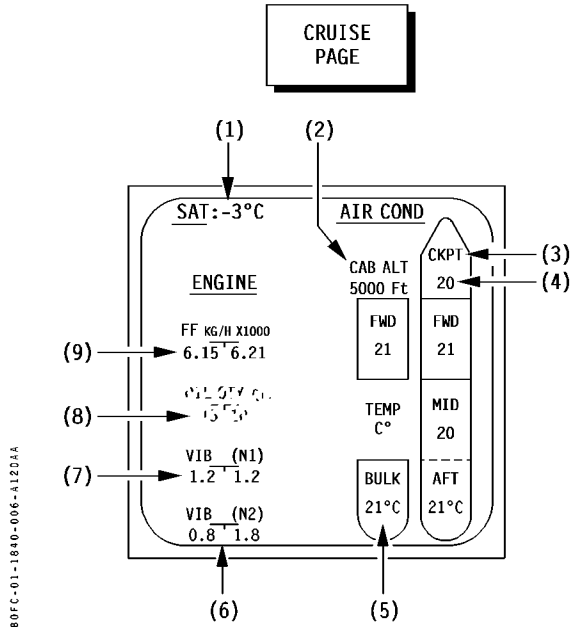

- (1) **STATIC AIR TEMPERATURE**
- (2) **CABIN ALTITUDE**
- (3) **ZONE NAME**
- (4) **ZONE TEMPERATURE**
- (5) **BULK CARGO COMPARTMENT TEMP**
- (6) **ENGINE N2 VIBRATION**
- (7) **ENGINE N1 VIBRATION**
- (8) **OIL QUANTITY**
- (9) **FUEL FLOW**

Mod : 2989

PW : All

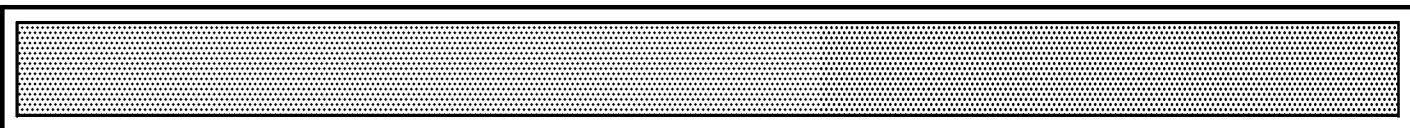

NORMAL DISPLAY MODE

- When both ECAM CRT's are operating and :
 - no warning is activated,
 - no advisory is activated,
 - no system page is manually selected,
 the ECAM operates in the flight-phase-related mode.

- The MEMO page is displayed on the left CRT to recall the list of systems which have been selected (and are normally operated only temporarily).

- The right CRT displays the flight-phase-related system page (for exemple the CRUISE page, as illustrated hereafter).

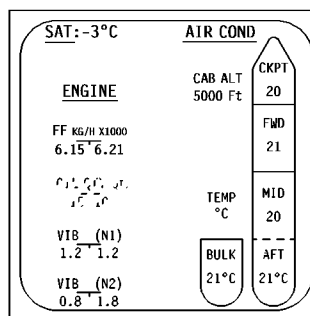
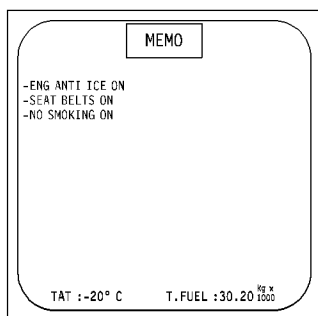

MASTER WARNING

MASTER CAUTION

MASTER WARNING and MASTER CAUTION lights are extinguished

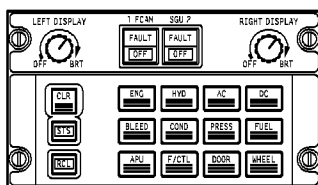

All lights on the ECAM control Panel are extinguished.

80FC-01-1850-001-A1004A

Mod : 5051

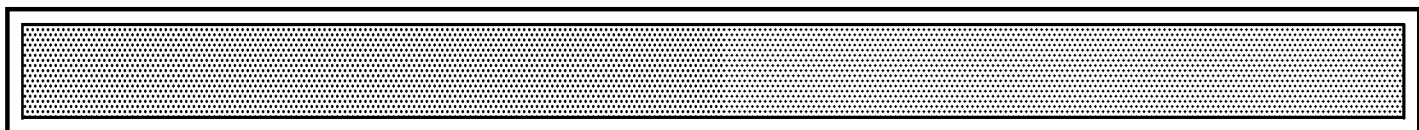

MEMO PAGE

- The MEMO page is the basic display of the left ECAM CRT.

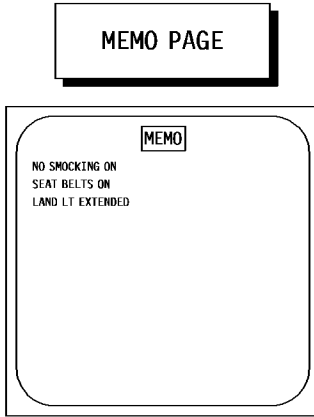

- This page lists the systems or functions which have been selected for temporary use.
- The MEMO page is displayed when :
 - No warning page is displayed, and
 - The STATUS page is not displayed.

Note : If a warning page is displayed, when it is cleared, if no STATUS page message exist, the MEMO page is displayed. If there is a STATUS page, the MEMO page will be displayed when the STATUS page is cleared.

- The MEMO page always displays :
 - The TAT,
 - The Total fuel quantity (T. FUEL),
 - A magenta STATUS message is displayed in the upper right corner if there are messages on the STATUS page,
 - A magenta TO INHIB or LDG INHIB message is displayed in the upper left corner during takeoff and landing phases. This indicates that most non-critical ECAM warnings are being inhibited.

- The messages displayed on the MEMO page are listed here after:
 - CAB PRESS MAN CTL (only with electrical pressurization system, per Mod 3881),
 - IRS IN ALIGN,
 - TAT IN ICING RANGE,
 - ENG ANTI ICE ON,
 - WING ANTI ICE ON,
 - APU RUNNING,
 - CONTINUOUS RELIGHT ON,
 - SEAT BELTS ON,
 - NO SMOKING ON,
 - FUEL FEED MAN CTL,
 - CTR TANK FEEDING,
 - FUEL X FEED,
 - PARKING BRAKE ON,
 - EXT PWR CONNECTED,
 - SPD BRAKES EXTENDED (flashes if throttles above IDLE),
 - LDG LIGHT EXTENDED,
 - ECON FLOW SELECTED,
 - FWD/BULK CARGO COOLING ON, if Mod 3448 installed.

Eng. : PW ALL or GE 80C2

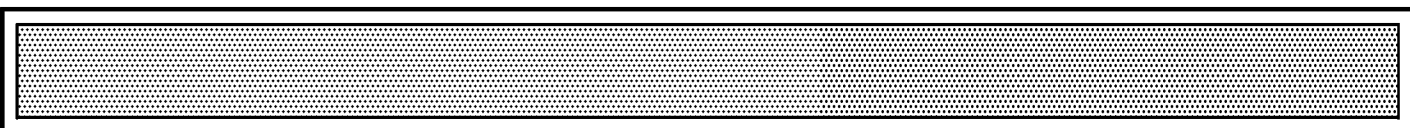

**MEMO PAGE (Cont'd)**

- T. FUEL : XX.X Kg (Lbs) × 1000 (lower right corner of the CRT),
- TAT : XXX°C (°F) (lower right corner of the CRT),
- GW : XXX.XX Kg (Lbs) × 1000 (right bottom of the CRT), only if Mod 4801 fitted,
- CG : XX.X % (left bottom of the CRT), only if Mod 4801 or Mod 4541 fitted,
- TOW : XXX.XX Kg (Lbs) × 1000 (right bottom of the CRT), only if Mod 4541 fitted,
- FUEL TEMP : XXX°C (°F) (right bottom of the CRT), only if Mod 5875 fitted,
- ZFW : XXX.X Kg (Lbs) × 1000, only if 6536 fitted,
- ZFCG : XX.X %, only if 6536 fitted.

FLIGHT-PHASE-RELATED PAGES

Note : the system pages illustrated here after are "typical" and may not reflect customer options or modifications.

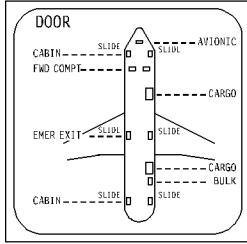
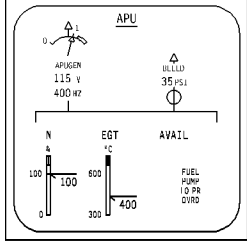
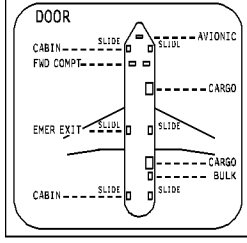
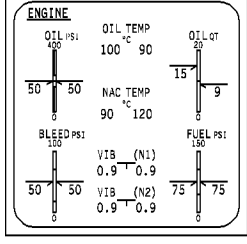
PHASE OF FLIGHT	SYSTEM PAGE	FLIGHT-PHASE-RELATED PAGES
<p>From electric power on until first engine start</p>	<p>DOOR page <i>To monitor door status</i></p>	 <p>Diagram of the aircraft fuselage showing the status of various doors: CABIN, FWD COMPT, EMER EXIT, and CABIN. Slides are indicated for each door. Labels include AVIONIC, CARGO, and BULK. Reference code: BOFC-01-1850-004-A001AA.</p>
<p>From APU master switch ON until 15 seconds after APU reaches 95 % N.</p>	<p>APU page <i>To monitor APU start</i></p>	 <p>APU page diagram showing APU speed (N) and temperature (EGT, AVAIL). Fuel flow is also indicated. Reference code: BOFC-01-1850-004-B001AA.</p>
<p>15 seconds after APU has reached 95 % N</p>	<p>DOOR page <i>to monitor slides arming status</i></p>	 <p>Diagram of the aircraft fuselage showing the status of various doors: CABIN, FWD COMPT, EMER EXIT, and CABIN. Slides are indicated for each door. Labels include AVIONIC, CARGO, and BULK. Reference code: BOFC-01-1850-004-C001AA.</p>
<p>When START selector is placed in START A, B or CRANK position</p>	<p>ENGINE START page <i>(same as ENGINE page but with a BLEED pressure indication).</i></p>	 <p>ENGINE START page diagram showing OIL PSI, OIL TEMP, OIL QT, BLEED PSI, VIS (N1), VIS (N2), and FUEL PSI. Reference code: BOFC-01-1850-004-D001AA.</p>

FLIGHT-PHASE-RELATED PAGES (Cont'd)

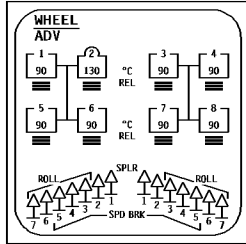
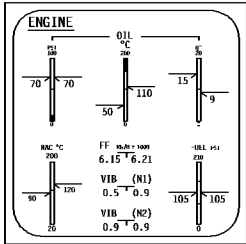
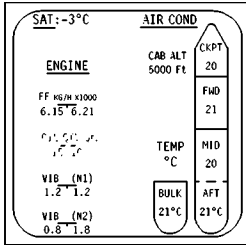
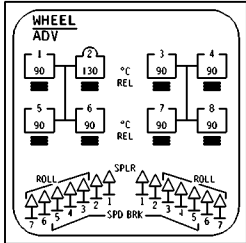
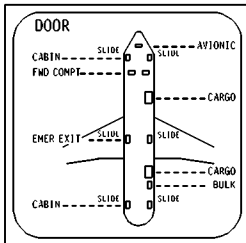
PHASE OF FLIGHT	SYSTEM PAGE	FLIGHT-PHASE-RELATED PAGES
After both engines have been started and the START selector is selected back to OFF	<p>WHEEL page</p> <p><i>To monitor brake temps during taxi out</i></p>	 <p>80FC-01-1850-003-410044</p>
When throttle levers are advanced for takeoff	<p>ENGINE page</p> <p><i>To monitor engine parameters during takeoff</i></p>	 <p>80FC-01-1850-005-810044</p>
After takeoff, when slats are retracted or when both throttle levers are retarded below T.O. power	<p>CRUISE page</p> <p><i>To monitor main engine parameters, Cabin altitude, cabin and cargo compartments temperature</i></p>	 <p>80FC-01-1850-005-C10044</p>
When landing gear handle is selected down	<p>WHEEL page</p> <p><i>To monitor brake anti-skid release signals, brakes temperature and ground spoilers deployment</i></p>	 <p>80FC-01-1850-005-810044</p>
At second engine shutdown	<p>DOOR page</p> <p><i>To monitor doors and slides status</i></p>	 <p>80FC-01-1850-005-E10044</p>

Mod : 6269

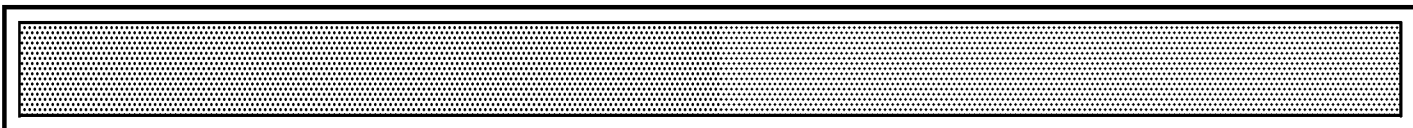

- The following typical flight profile summarizes the flight phases defined for :
 - the system display flight-phase-related mode,
 - the warnings flight-phase inhibition.

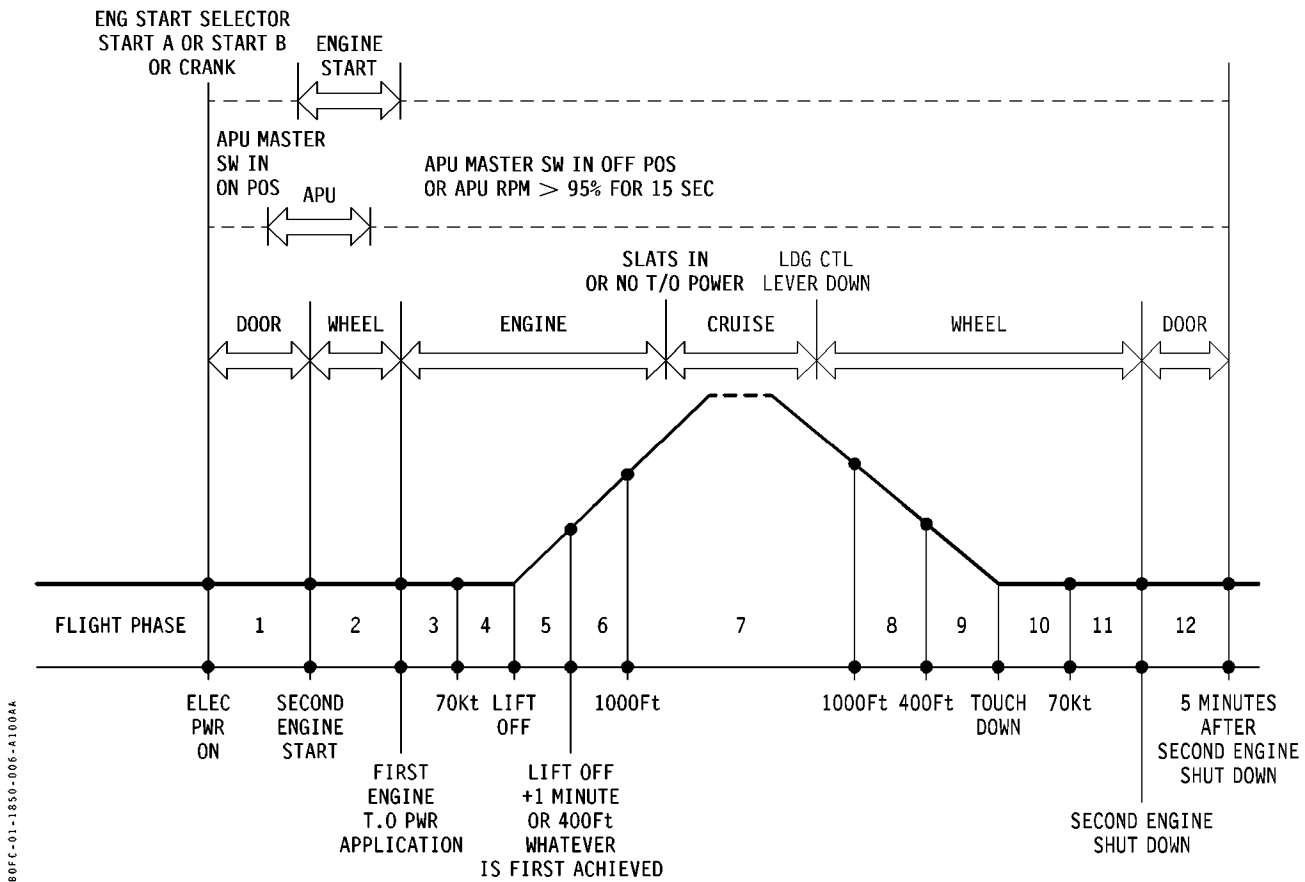

80FC-01-1850-006-A10044

Mod : 6269

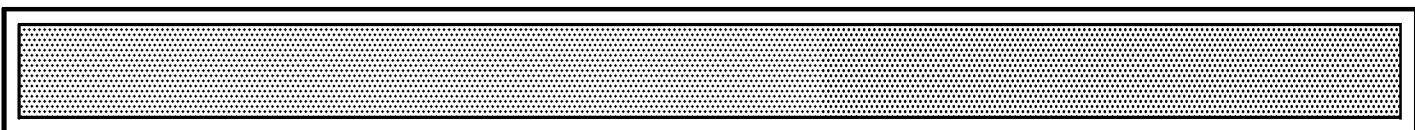

GENERAL

- If a system parameter is trending out of its normal range, but has not reached its warning threshold, the ECAM activates the Advisory mode.
- The activation of the Advisory mode results in the automatic display of the system page related to the affected system and parameter.
- No audio warning is associated with the Advisory mode.
- The activation of the Advisory mode is inhibited on the ground, and until slats have been retracted after takeoff.

- On the ECAM control panel, the associated system key illuminates.

Pressing the key cancels the Advisory mode display :

- the system key extinguishes,
- the system display reverts to the flight-phase-related page.

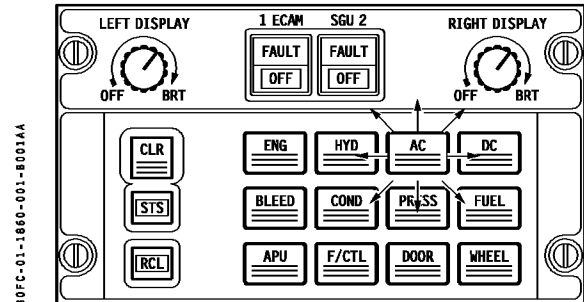
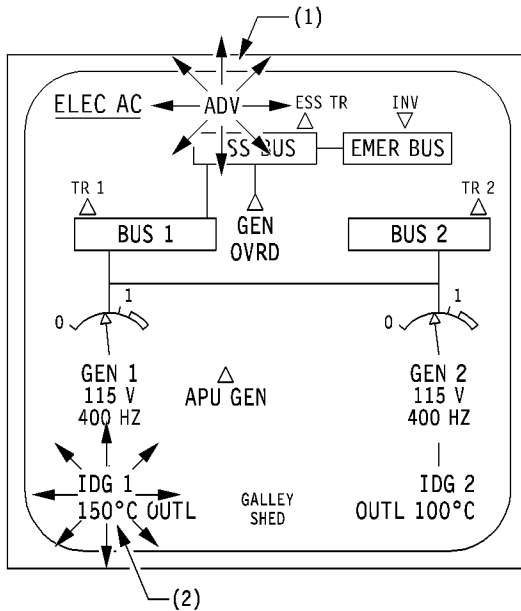

(1) ADV (Advisory) message

- An attention-getter message (ADV) is displayed after the system page title and flashes white until the page is deselected, by pressing the associated key on the ECAM control panel.
- The affected parameter is still displayed in green but is pulsing.

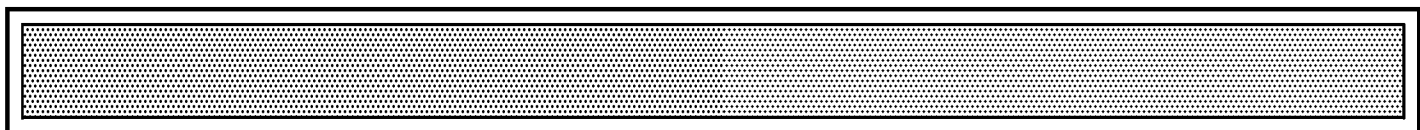

WARNING PAGE PRESENTATION

PRIMARY FAILURES

- The name of the primary failure is boxed.

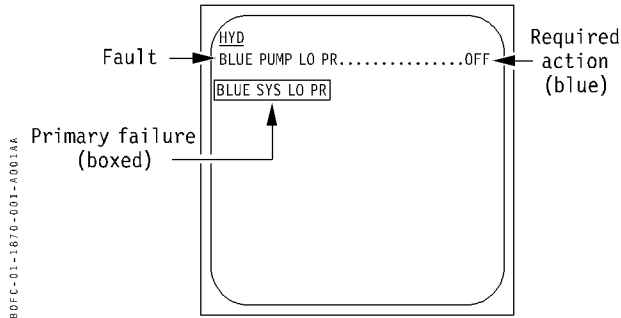

SECONDARY FAILURES

- The title of the system affected by secondary failures is identified with an asterisk.

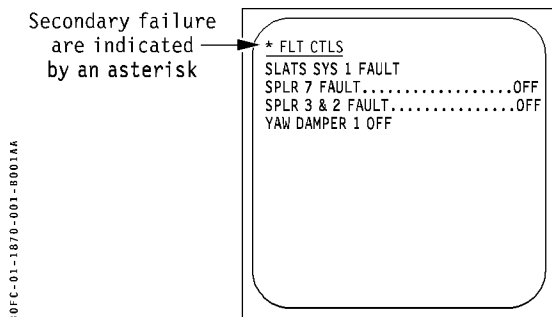

INDEPENDENT FAILURES

- Independent failure are displayed without asterisk or boxed items.

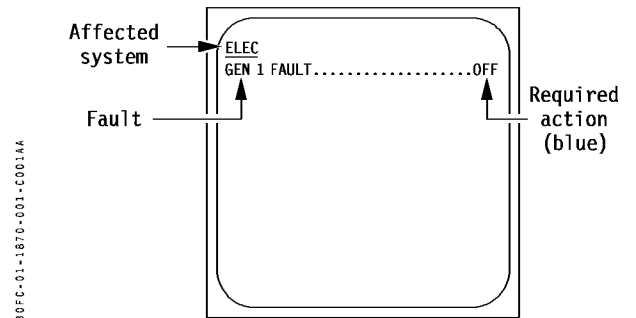

- If an independent failure occurs while secondary failures are displayed, a flashing green CLEAR message is displayed at the bottom of the warning page if there is not enough space on the CRT to display the new warning :

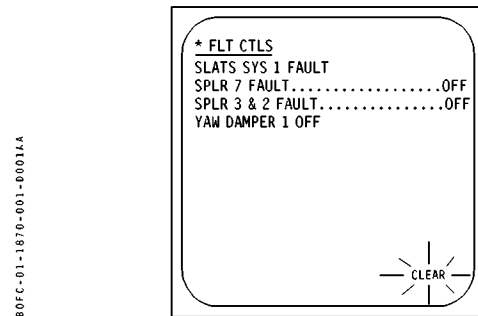

- When the CLR pushbutton is pressed on the ECAM control panel, the new warning is displayed on the next warning page.

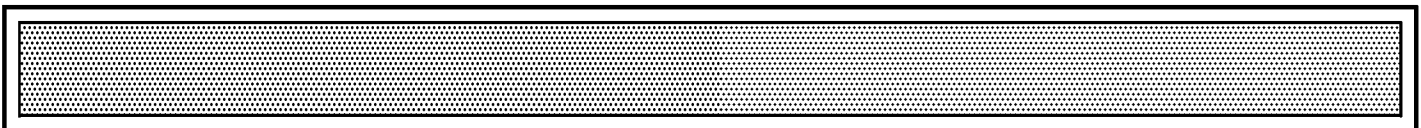

ACTION FEEDBACK

- When a blue ECAM action is performed, the action feedback is displayed on the warning page to confirm that the action is complete.

Note : Action feedback is largely generated by the SDAC. Thus, if the SDAC is lost (component failure or loss of AC BUS 1) most action feedback is lost.

RED WARNINGS

- When an ECAM action is performed, the associated line disappears :

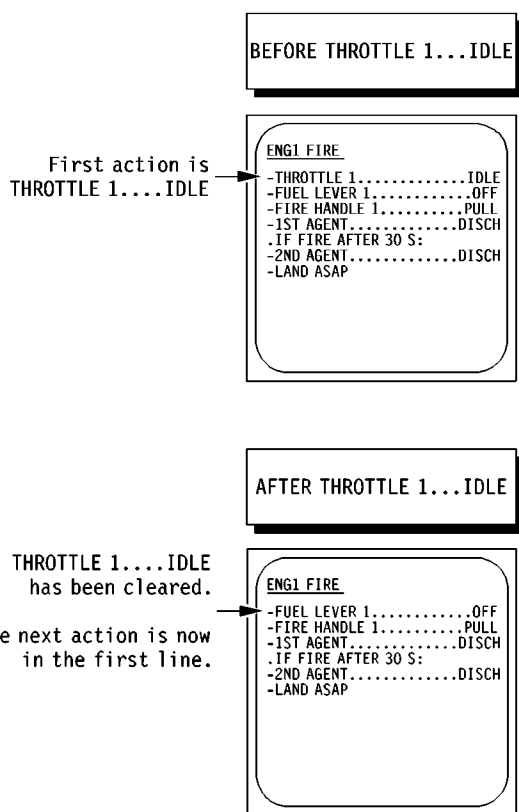

AMBER CAUTIONS

- For amber cautions, when the action is performed, the line turns white :

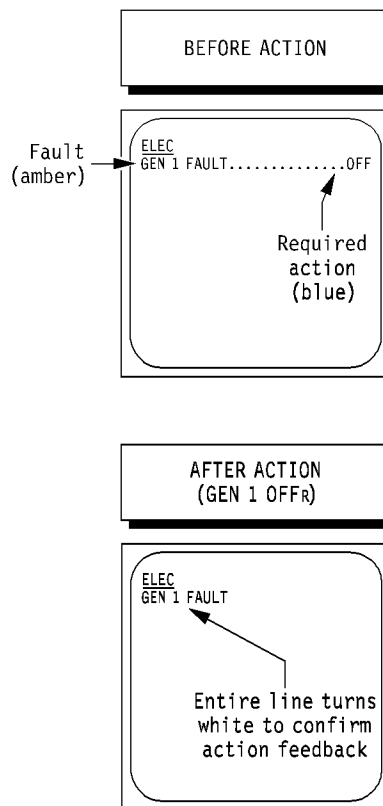

- If a system which has been set to OFF/R is successfully reset, the affected warning page is cleared from the warning display and the MEMO or STATUS page is displayed.

CONDITIONAL ACTIONS

- Some warning pages include **conditional** action steps (e.g. : IF RAPID DECOMPRESSION, in the EXCESS CAB ALT procedure) which require the crew to decide whether to perform the related action(s) or not :

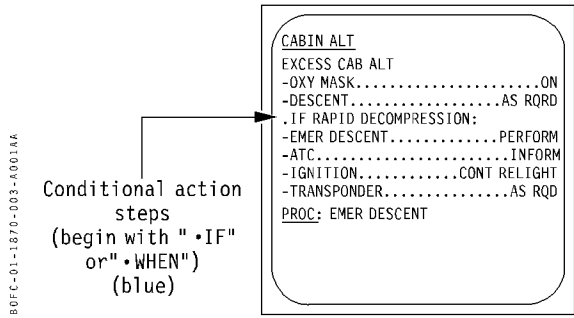

Note : There is no action feedback for conditional action steps. Whether the actions are performed or not, the corresponding action lines remain displayed in blue.

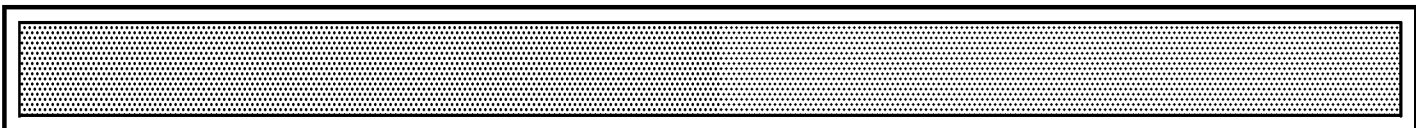

STATUS PAGE

- The STATUS page is displayed after all warning pages are cleared to provide a summary of the aircraft's condition :
- The following example relates to a DUAL HYD BLUE + YELLOW SYS LO PR (i.e. GREEN remaining) condition.

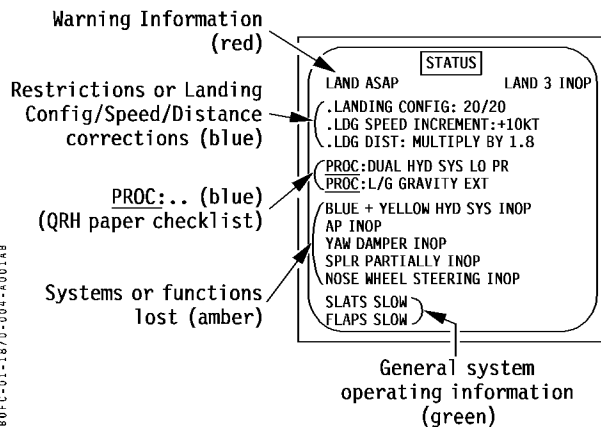

- The STATUS page provides the following information or references :
 - LAND ASAP message, if applicable,
 - Landing Category capability downgrade, if applicable,
 - Speed and altitude limitations,
 - Configuration recommendations, landing speed increments and landing distance multiplication factors,
 - Emergency or Abnormal procedures which require reference to a QRH Procedure (PROC : - - - - -),
 - Systems / functions lost or degraded,
 - Additional information related to systems operation.

- The STATUS page is displayed :

– **Automatically :**

When all warning pages have been cleared from the warning display.

Note 1 : If there are no STATUS messages, this page is skipped, and the MEMO page is displayed directly.

Note 2 : From flight phase 1 to 5 and from flight phase 9 to 12, the STATUS page is skipped when a warning page is cleared, and the MEMO page is displayed directly.

R
R

– **Manually :**

From the MEMO page, the STATUS page can be displayed by pressing the STS pushbutton.

When the STATUS page has been manually selected the CRL pushbutton must be pressed to return to the MEMO page.

Note : If there are no status messages, NORMAL is displayed on the STATUS page as long as the STS pushbutton is pressed. When released, the MEMO page is displayed.

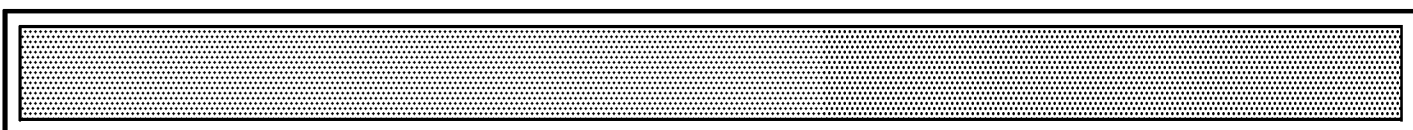

SYSTEM DISPLAY

- When in their normal ranges all digital values and analog indications are green. When an indication reaches its warning level, the associated analog pointer and digital value become amber (abnormals) or red (emergencies).
- In case of loss of sensor electrical power or loss of signal, the associated indication is replaced by an amber "XX".

Note 1 : All units (e.g. : °C, PSI, V, Hz, etc...) are displayed in cyan.

Note 2 : System page titles :

When a system page is displayed automatically (except by advisories) the page title is green.

If a system page is manually selected, or displayed by an advisory, its title is white.

PUMP and VALVE SYMBOLS

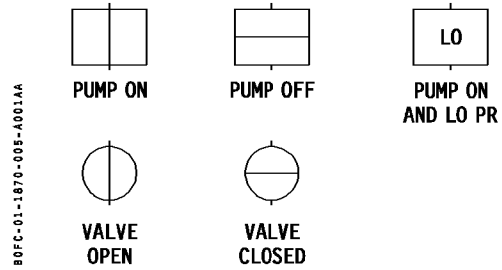

SYSTEM PAGE COLOR CODING

CONDITION	COLOR USED
In use	Green
Unusable	Amber
Not in use	Not shown
Off	White
Normal	Green
Abnormal	Amber
Emergency	Red

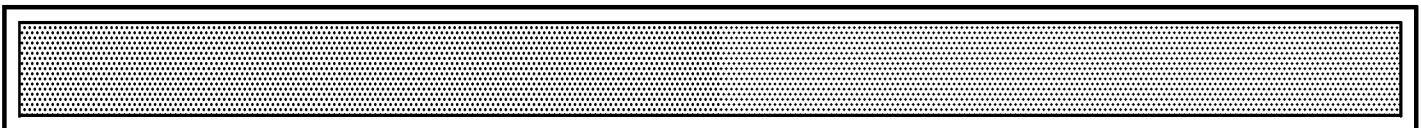

ECAM
 ABNORMAL FLIGHT CONDITIONS
 INDEPENDENT FAILURES

ECAM SEQUENCE FOR INDEPENDENT FAILURES :

	L CRT	R CRT	
1) When warning is detected:	. Applicable (red or amber) warning page is displayed	Associated system page is displayed	MASTER lights: Applicable light illuminates flashing.* ECAM Control Panel: CLR pushbutton illuminates Local Warning light: FAULT light is illuminated Audio Warning is activated*
2) When crew performs required actions:	Action feedback is indicated on warning page: . amber warning page: action step line turns white . red warning page: Line is cleared from display	System page provides confirmation on the results of ECAM actions	MASTER lights extinguished ECAM Control Panel: CLR pushbutton is still illuminated Local Warning: extinguished Audio Warning: Cancelled
3) When crew presses CLR pushbutton on ECAM control panel to clear the warning page:	STATUS page is displayed . Required QRH procedures are listed . Applicable limitations/restrictions are provided	The flight-phase-related system page is displayed	MASTER lights: extinguished ECAM Control Panel: CLR pushbutton still illuminated if information on STATUS page Local Warning light: extinguished Audio Warning: Cancelled
4) When crew presses CLR pushbutton on ECAM control panel to clear the STATUS page:	MEMO page is displayed	No Change	MASTER light: extinguished ECAM Control Panel: CLR light extinguishes Local Warning light: extinguished Audio Warning: Cancelled
5) If the ECAM control panel RCL pushbutton is pressed to review the warning page procedures:	Warning pages are displayed in the same order as originally activated	Associated system pages are displayed in sequence with warning pages	MASTER lights: Applicable lights remain extinguished ECAM Control Panel: CLR pushbutton illuminates Local Warning light: is extinguished unless failure is still present Audio Warning: cancelled

R

R

80FC-01-1871-001-A100AB

Note : If a warning page is automatically cleared when the corrective actions are performed (e.g. : resetting a tripped Yaw Damper lever), the associated WLDP and CLR lights extinguish.

* Until either MASTER light is pressed.

Mod : 5051

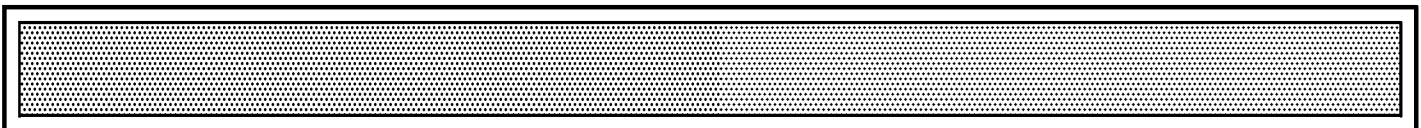

ECAM

ABNORMAL FLIGHT CONDITIONS

INDEPENDENT FAILURES

1.18.71

PAGE 2

REV 31

SEQ 001

LEFT BLANK INTENTIONALLY

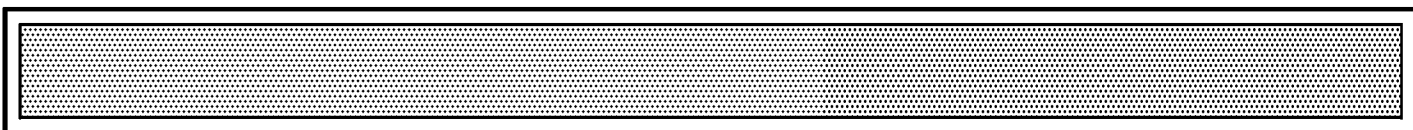

ECAM SEQUENCE FOR PRIMARY AND SECONDARY FAILURES :

	L CRT	R CRT	
1) When warning is detected:	<ul style="list-style-type: none"> Applicable primary (red or amber) warning page is displayed 	Associated system page is displayed	MASTER lights: Applicable lights illuminate flashing* ECAM Control Panel: CLR pushbutton illuminates Local Warning light: Primary and Secondary FAULT lights illuminate Audio Warning is activated*
2) When crew performs required actions for primary failure:	Action feedback is indicated on warning page .red warning pages: line is cleared from display .amber WD pages: action step line turns white	System page provides confirmation on the results of ECAM actions	MASTER lights: the light remain extinguished ECAM Control Panel: CLR pushbutton is still illuminated Local Warning light: Primary FAULT light extinguished/Secondary FAULT light illuminated, Audio Warning: Cancelled
3) When crew presses CLR pushbutton to clear primary warning page:	Applicable secondary (red or amber) warning page(s) are displayed	System page associated with the first secondary warning page is displayed	MASTER lights: the lights remain extinguished ECAM Control Panel: CLR pushbutton is still illuminated Local Warning light: Primary FAULT light extinguished/Secondary FAULT light illuminated, Audio Warning: Cancelled
4) When crew performs required actions for secondary failure(s):	Action feedback is indicated on warning page: .amber warning pages: action step line turns white	System page provides confirmation on the results of ECAM actions	MASTER lights: the lights are extinguished ECAM Control Panel: CLR pushbutton is still illuminated Local Warning lights: extinguished Audio Warning: Cancelled
5) When crew presses CLR pushbutton to clear secondary warning pages (until STATUS page is displayed)	<ul style="list-style-type: none"> Other secondary Warning pages are displayed until the STATUS page is reached. Required QRH procedures (PROC:) are indicated Applicable limitations/restrictions are listed 	System pages associated with other secondary warning pages are displayed until STATUS page is displayed on warning display, then the flight-phase related system page is displayed	MASTER lights: extinguished ECAM Control Panel: CLR pushbutton is still illuminated if information on STATUS page Local Warning lights: extinguished Audio Warning: Cancelled

80FC-01-1872-001-A100A4

* Until either MASTER light is pressed.

Mod : 5051

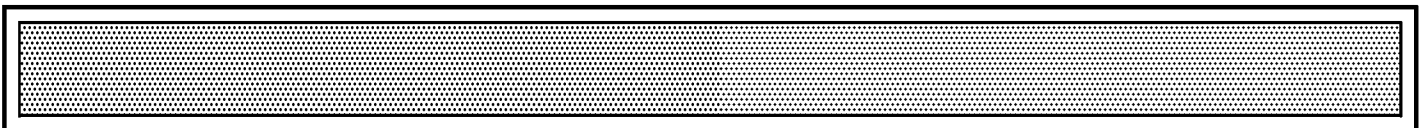

R ORDER OF EVENTS and INDICATIONS FOR PRIMARY AND SECONDARY FAILURES (continued) :

L CRT

R CRT

6) When crew presses CLR pushbutton on ECAM control panel to clear the STATUS page:

MEMO page is displayed

No Change

MASTER lights: lights remain extinguished
 ECAM Control Panel: CLR light extinguishes
 Local Warning lights: extinguished
 Audio Warning: Cancelled

7) if the ECAM control panel RCL pb is pressed to review the WD pages:

Warning pages are redisplayed in the same order as originally displayed.

Associated system pages are displayed in sequence with warning pages

MASTER light: Applicable lights illuminate
 ECAM Control Panel: CLR pushbutton illuminates
 Local Warning lights: illuminate if failures are still present
 Audio Warning: cancelled

R

80FC-01-1872-002-A100AB

Mod : 5051

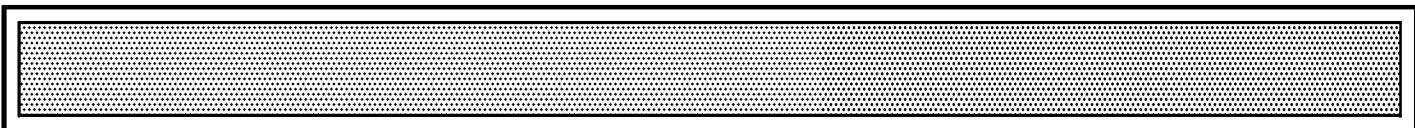

SINGLE FWC LOSS

Note : The loss of one FWC can be caused by the loss of the AC BUS 2 or the AC EMER Bus.

- If one FWC is lost :
 - ECAM cannot provide warning pages for any Amber Cautions/Alerts,
 - The remaining FWC can still activate the MASTER CAUTION warning for part of amber faults.
 - red warnings are not affected as all red warning signals are received by both FWCs.
 - MASTER CAUTION light illuminates (1),
 - CLR pushbutton illuminates (2),
 - The lost amber cautions may only be identified by monitoring the local indications on the systems panels (3).

Note : Some types of action feedback are lost.

- The MASTER CAUTION light is cancelled by pressing the pushbutton.
- When the CLR pushbutton is pressed :
 - The CLR pushbutton light extinguishes (4),
- The warning pages displays the message :
FWS AMBER FAULT MONITOR SYS
 above the MEMO page (5).

For all amber cautions, no ECAM warning page is available on the left CRT.

The paper check-list (QRH) must be used, in conjunction with local indications.

The ECAM message :

FWS AMBER FAULT MONITOR SYS
 indicates the loss of a single FWC.

Should the message subsequently become :

FWS FAULT MONITOR SYS,
 this would indicate the loss of the second FWC (and the loss of all ECAM and audio warnings).

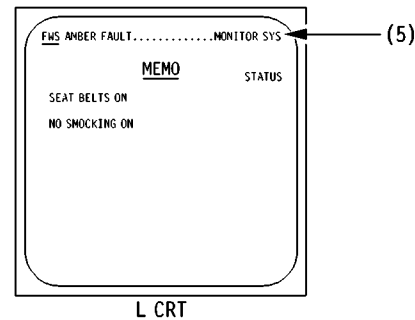
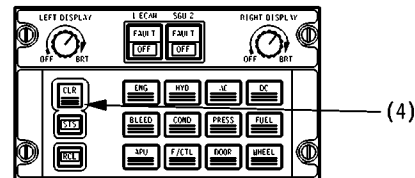
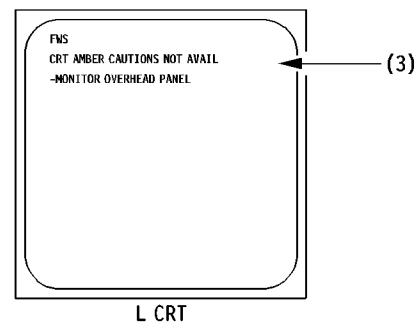
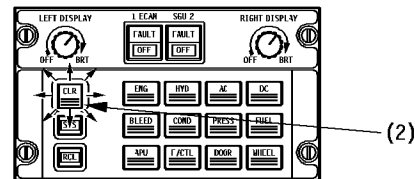
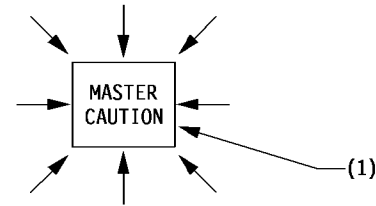

80FC-01-1880-001-4100A4

Mod : 5051

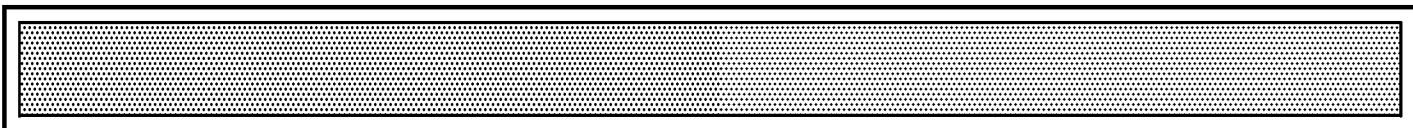

ECAM
ECAM COMPONENT FAILURES
OPERATION WITH ECAM PARTIALLY INOPERATIVE

LOSS OF BOTH FWC

- If the second FWC is lost (e.g. loss of AC BUS 2 and AC EMER BUS or loss of one bus and loss of the non-related FWC), the only indication is that the word "AMBER" is cleared from the MEMO page message.

- R
- MASTER CAUTION light illuminates.
 - The warning page displays the message :
 FWS FAULT MONITOR SYS
 - **No ECAM warnings are available.**
- R
- **No audio, or CRT warnings are available.**
 - **Overhead panel and other local indications must be scanned more frequently.**

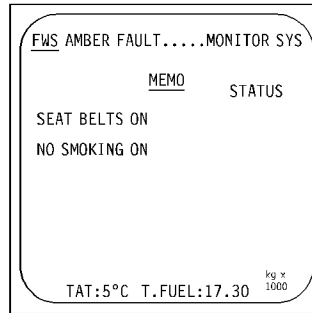

Loss of a single FWC

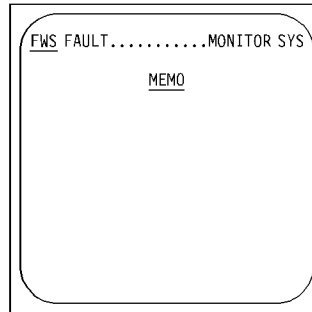

Loss of both FWC

SUMMARY OF EFFECTS OF SINGLE AND DUAL FWC LOSS

	AMBER WARNINGS	RED WARNINGS
R ONE FWC LOST	<ul style="list-style-type: none"> • All amber warning pages are lost. • Paper checklists (QRH) must be used for amber cautions and alerts. • 50 % of ECAM amber warnings are lost (Only local indications are available). • For the remaining 50 % ECAM amber warnings, only the Audio Chime warnings are available (no warning page). 	<ul style="list-style-type: none"> • No effect, except that action feedback may be lost.
BOTH FWC LOST	<ul style="list-style-type: none"> • All ECAM warnings are lost. • Local warning lights must be monitored. • All red and amber warning pages are lost. • No Audio warning or MASTER CAUTION/WARNING light is available. • QRH procedures must be used for all fault conditions. 	

Mod : 5051

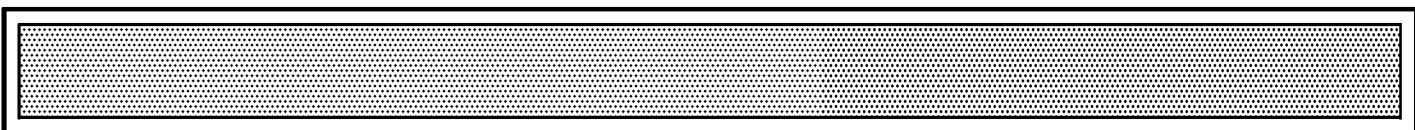

FWC 1 AND 2 - AUDIO MODULE FAILURE

- If case of loss of the FWC audio modules no aural warnings are available.
- The MASTER CAUTION light illuminates.

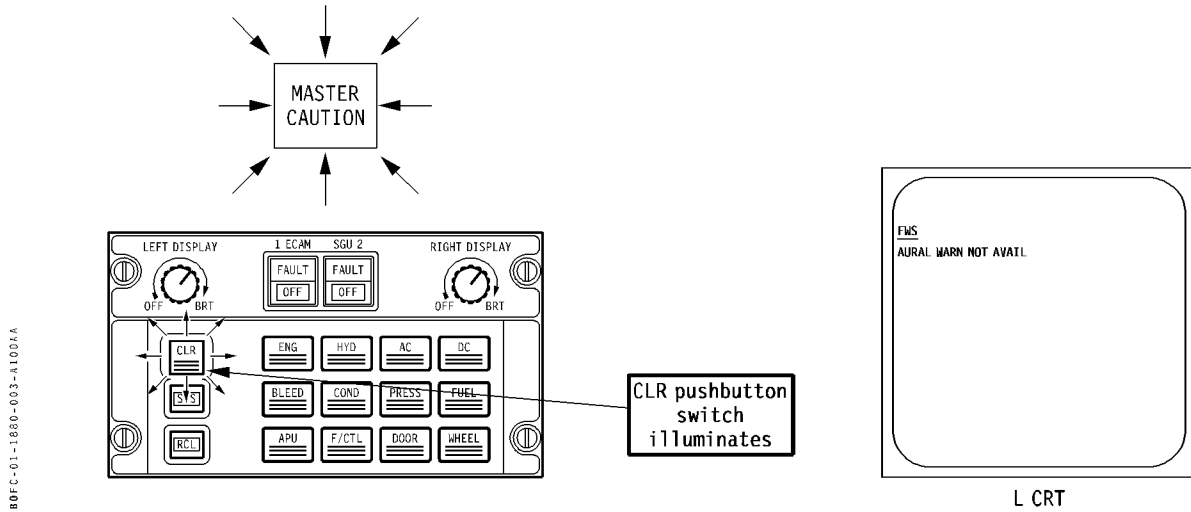

- The associated warning page is displayed on the left CRT.
- The MASTER CAUTION lights extinguish when either light is pressed.
- This warning is cleared by pressing the CLR pushbutton :

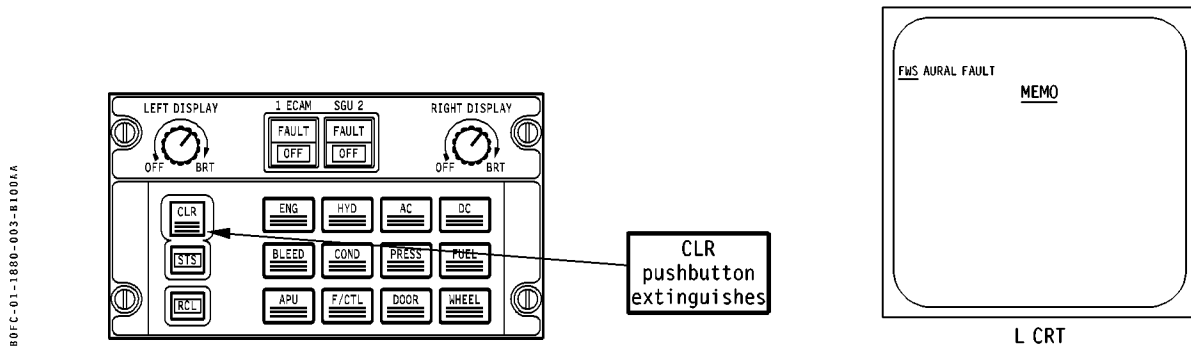

- R • The left CRT displays the message :
- FWS AURAL FAULT
 above the MEMO page.

Mod : 5051

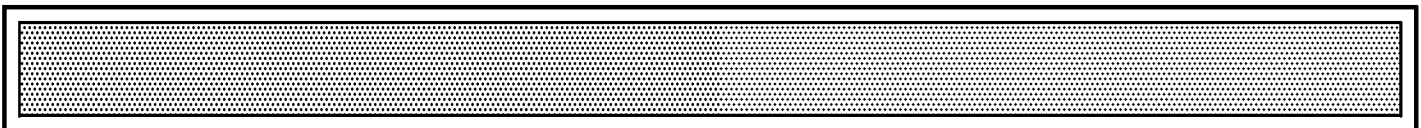

LOSS OF SYSTEM DATA ANALOG-DIGITAL CONVERTER (SDAC)

- In case of SDAC failure, or loss of electrical power (AC BUS 1/AC ESS BUS), the following ECAM functions are lost :
 - MEMO page messages,
 - Most ECAM action feedback,
- R – All system pages (except FUEL QTY on the FUEL page and indications on WHEEL page),
- Some STATUS messages are also lost.
- With no aircraft system failures :
 - Messages on MEMO page and on system display indicate that data are lost (except Fuel Quantity on FUEL page).

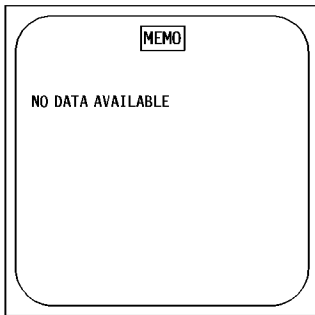

L CRT

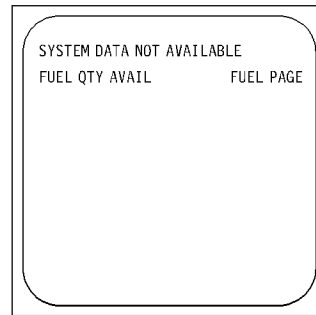

R CRT

- If an aircraft system failure occurs (e.g. : GEN FAULT) :

The associated warning page is displayed, but action feedback is not provided, the message NO ACTION FEED BACK ON CRT indicates that action feedback will not be displayed when action steps are performed.

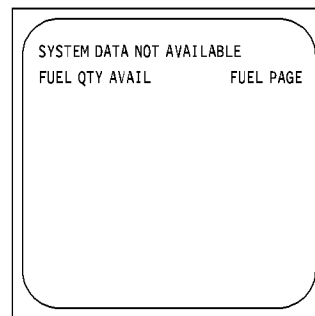
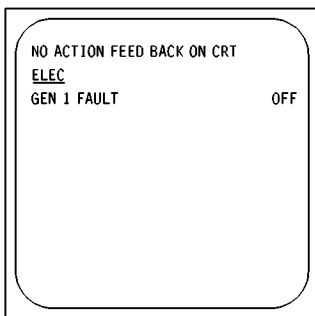

Mod : 3781

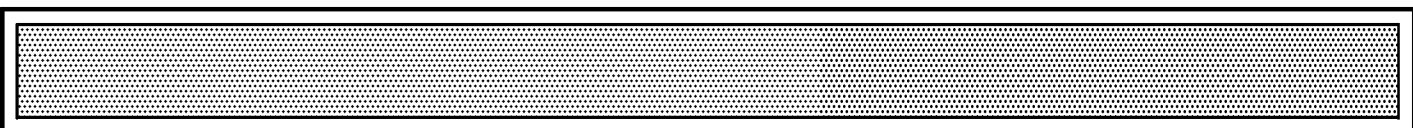

LOSS OF SYMBOL GENERATOR UNIT (SGU)

- If case of an ECAM SGU failure or loss of electrical power (AC BUS 1 OFF for SGU 1 and AC BUS 2 OFF for SGU 2), the associated SGU FAULT light illuminates on the ECAM control panel, and a white diagonal line is displayed on the affected CRT.

R

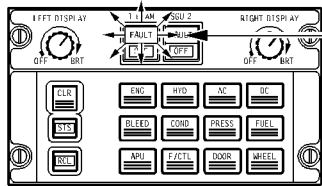

The affected SGU pushbutton's FAULT light illuminates on the ECAM control panel

A white diagonal line is displayed on the affected CRT

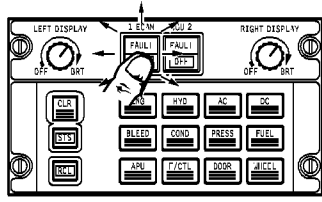
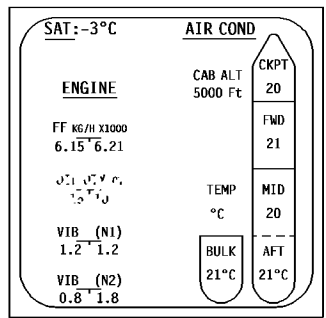
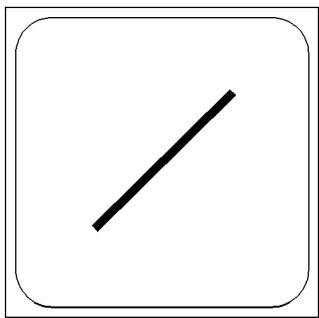

The affected SGU is switched OFF by pressing the associated pushbutton switch

The affected display returns to normal operation

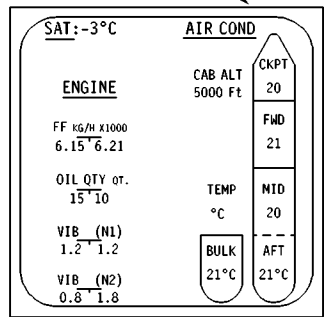
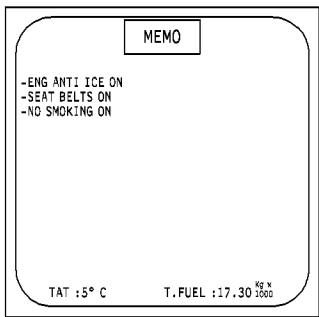

80FC-01-1880-005-A001AB

- After the affected SGU is switched OFF, the ECAM CRTs return to normal operation (the remaining SGU supplies both CRTs).

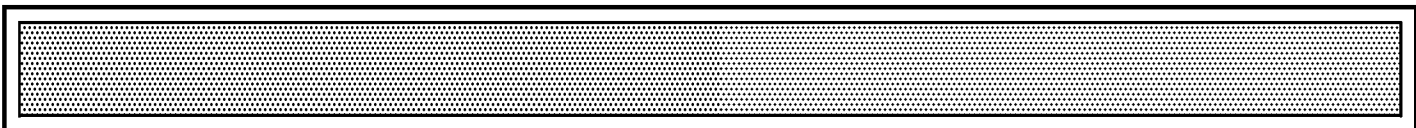

LOSS OF A SINGLE CRT

- R • In case of CRT failure or loss of electrical power (L CRT – AC BUS 1, R CRT – AC BUS 2) the display is blanked.
- The affected CRT must be switched OFF.
- The remaining CRT then provides all normal functions, as follows.
- With no warnings or cautions present, the MEMO page is display on the operative CRT :
 - All system pages can be manually selected (except the CRUISE page).

- If an ECAM warning or caution occurs, the warning pages replace the MEMO page on the operative CRT :
 - the related system page can be selected after clearing all the warning pages and the STATUS page,
 - after reviewing the system page, pressing the CLR pushbutton redisplay the first warning page.

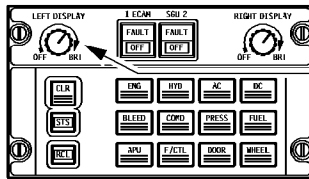

The affected CRT must be turned OFF

• **WITHOUT AIRCRAFT SYSTEM FAILURE:**
 L CRT OFF

R

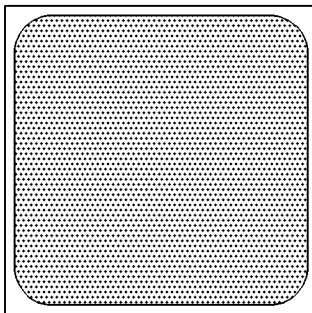

R CRT displays the MEMO page

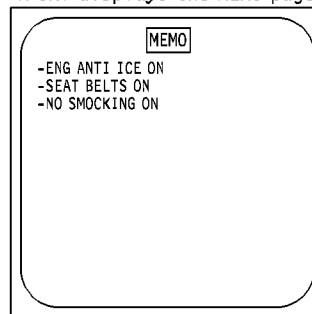

• **WITH AN AIRCRAFT SYSTEM FAILURE:**
 L CRT OFF

R

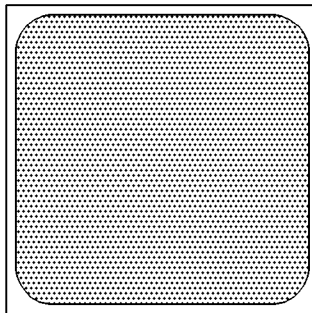

R CRT displays the first warning page

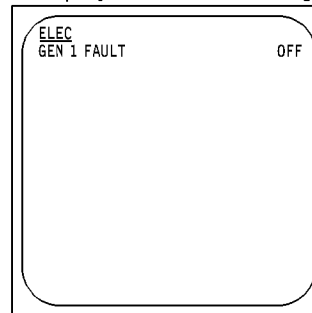

80FC-01-1880-006-A001A8

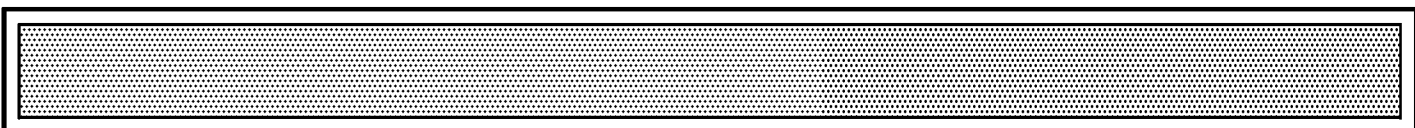

LOSS OF BOTH ECAM CRTs

- In case of double CRTs failure or loss of electrical power supply (e.g. AVIONICS SMOKE drill or FLIGHT ON BAT ONLY), the ECAM still provides :
 - Audio warnings, and
 - MASTER CAUTION/WARNING lights and local warnings.

L CRT OFF

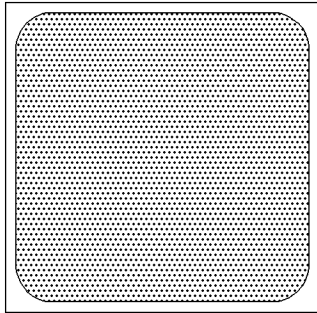

R CRT OFF

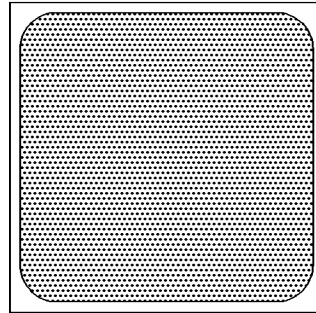

R

80FC-01-1880-007-A100AB

Mod : 5051

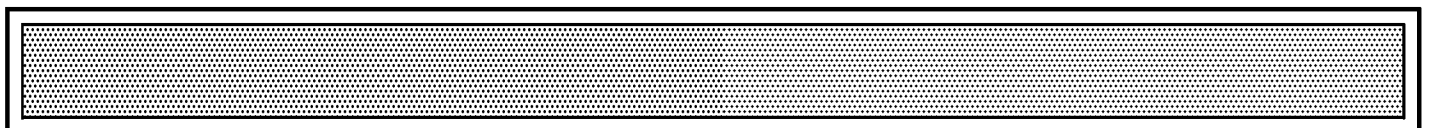

ECAM

1.18.80

ECAM COMPONENT FAILURES

PAGE 8

OPERATION WITH ECAM PARTIALLY INOPERATIVE

REV 30

SEQ 100

LEFT BLANK INTENTIONALLY

Mod : 5051

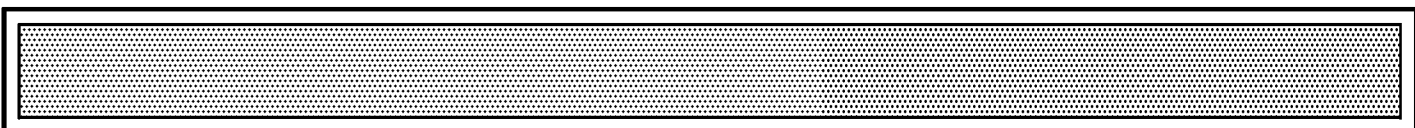

SUB-CHAPTER TITLE	PAGE	SUB-CHAPTER TITLE	PAGE
1.19.01 <u>SPECIFIC VOCABULARY AND ABBREVIATIONS</u>		1.19.40 <u>CDU PAGES OPERATIONAL DESCRIPTION</u>	
1.19.10 <u>OVERVIEW</u>		1 – STATUS / DATA BASE page	1
1 – System architecture	1	2 – INIT pages	2
2 – Summary of FMS functions and operations	2	3 – F-PLN pages	6
3 – Pages and functions accessing diagram	4	3.1 Page A display	6
4 – FMC internal organization	5	3.2 Constraints on F-PLN A	6
5 – DATA BASE contents	5	3.3 Page B display	6
6 – List of FMS pages and associated functions	6	3.4 Situational commands	8
		3.5 Markers	9
1.19.20 <u>CDU DESCRIPTION</u>		4 – F-PLN LATERAL REVISIONS	10
1 – CDU physical description	1	4.1 Waypoint insertion / deletion on the F-PLN pages	10
2 – CDU operating and display rules	2	4.2 LAT REV page	12
2.1 Page accessing	2	4.2.1 SID page	14
2.2 Small or large font	2	4.2.2 STAR page	16
2.3 Type of displayed WPT	2	4.2.3 AIRWAY page	18
2.4 Example of pages displayed and symbols	3	4.2.4 HOLD page	20
2.5 Insertion of data	4	4.2.5 PROC T page	22
2.6 Clearing data	4	4.3 DIRECT TO page	24
2.7 Automatic clearing	4	5 – F-PLN VERTICAL REVISIONS	26
2.8 Messages	4	Overview	
		5.1 Vertical revisions on F-PLN page A	26
1.19.30 <u>FLIGHT PLAN STRUCTURE AND GUIDANCE LOGIC</u>		5.1.1 Insertion of SPD / ALT Constraints	26
1 – Lateral F-PLN structure	1	5.1.2 Along Track offset	28
1.1 Overview	1	5.2 Vertical revisions on F-PLN page B	29
1.2 Lateral F-PLN legs	2	5.3 VERT REV page A	30
2 – Vertical F-PLN structure	3	STEP PRED page	32
2.1 Overview	3	5.4 VERT REV page B	34
2.2 Vertical F-PLN profile example	4	6 – TAKE OFF / APPROACH page	36
2.3 Vertical pseudo waypoints	5	7 – PROGRESS page	38
3 – Vertical Guidance and operation FCU-CDU interface management	6	7.1 FUEL PRED page	41
3.1 Vertical guidance	6	7.2 DES FORECAST page	42
3.1.1. General rules	6	8 – MODE page	44
3.1.2. Guidance for each flight phase	6	9 – TACT MODE page	46
3.2 Vertical operations	7	10 – ENGINE OUT function	48
3.2.1. CRZ altitude	7		
3.2.2. CRZ FL kept after a FCU altitude change IMM CLB, IMM DES	8		
3.2.3. Step climb, step descent	8		
3.2.4. Vertical path deviations	9		
3.2.5. Altitude conflicts	9		
3.2.6. Vertical summary	10		

Mod. : 6789

