



737 - 600/700/800/900 Flight Crew Training Manual

APPROVED BY: _____ (Original signed by)
J. R. Ratley
Senior Technical Pilot - 737

APPROVED BY: _____ (Original signed by)
M. F. Coker
Chief Pilot - Flight Training

APPROVED BY: _____ (Original signed by)
R. P. Craig
Chief Pilot - 737

APPROVED BY: _____ (Original signed by)
J. O. Creighton
Chief Pilot - Training, Technical, and Standards

APPROVED BY: _____ (Original signed by)
J. M. Eitel
FAA Principal Operations Inspector

Copyright © 1999
The Boeing Company
All Rights Reserved

Document Number FCT 737 NG (TM)
April 1, 1999

Revision Number: 5
Revision Date: October 31, 2005

Copyright Information

Boeing claims copyright in each page of this document only to the extent that the page contains copyrightable subject matter. Boeing also claims copyright in this document as a compilation and/or collective work.

The right to reproduce, distribute, display, and make derivative works from this document, or any portion thereof, requires a license from Boeing. For more information, contact The Boeing Company, P.O. Box 3707, Seattle, Washington 98124.

Boeing 707, 717, 727, 737, 747, 757, 767, 777, DC-8, DC-9, DC-10, MD-10, MD-11, MD-80, MD-90, BBJ, Boeing Business Jet, the Boeing logo symbol, and the red-white-and-blue Boeing livery are all trademarks owned by The Boeing Company; and no trademark license (either expressed or implied) is granted in connection with this document or otherwise.



Title	Chapter
Preface.....	0
Table of Contents	0.0
Model Identification.....	0.1
Introduction.....	0.2
Abbreviations.....	0.3
Revision Record.....	0.4
List of Effective Pages.....	0.5
General Information.....	1
Ground Operations.....	2
Takeoff and Initial Climb.....	3
Climb, Cruise, Descent and Holding.....	4
Approach and Missed Approach.....	5
Landing.....	6
Maneuvers.....	7
Non-Normal Operations.....	8
Index	



Intentionally
Blank



General

The airplane models listed in the table below are covered in this Flight Crew Training Manual.

Model
737-600
737-700
737-800
737-900

Model numbers are used to distinguish information peculiar to one or more, but not all of the airplanes. Where information applies to all models, no reference is made to individual model numbers.

If information is applicable to consecutively numbered models, a dash (–) is used in the model designator. For example, if information is applicable to 737-400 and 737-500 and 737-600 and 737-700 models, the model designator will show 737-400 – 737-700.

If information is applicable to models that are not consecutively numbered, a comma (,) is used in the model designator. For example, if information is applicable to only 737-300 and 737-800 models, the model designator will show 737-300, 737-800.



Intentionally
Blank



General

The Flight Crew Training Manual provides information and recommendations on maneuvers and techniques. The manual is divided into eight chapters: General Information; Ground Operations; Takeoff and Initial Climb; Climb, Cruise, Descent and Holding; Approach and Missed Approach; Landing; Maneuvers; and Non-Normal Operations.

General Information covers procedures and techniques not associated with a particular maneuver or phase of flight. Ground Operations covers information associated with airplane preflight, engine starting and taxi operations including taxi operations in adverse weather conditions. Chapters 3 through 6 are titled by phase-of-flight and contain information about airplane operations in each phase. The Maneuvers chapter covers maneuvers associated with climb, cruise, and descent, i.e., stall recovery and emergency descent. The Non-Normal Procedures chapter covers non-normal situations that may occur during any phase of flight. Each of the chapters has a preface which describes the chapter in more detail.

It is the responsibility of the individual airline to determine applicability of this manual to its operation.

Any questions about the content or use of this manual can be directed to:

Chief Pilot - Training, Technical, and Standards
Flight Crew Operations
Boeing Commercial Airplane Group
P. O. Box 3707, M/C 14-HA
Seattle, Washington 98124-2207 USA

Airplane Configuration

The Flight Crew Training Manual (FCTM) is intended to provide information in support of procedures listed in the Flight Crew Operations Manual (FCOM) and techniques to help the pilot accomplish these procedures safely and efficiently. The FCTM is written in a format that is more general than the FCOM. It does not account for airplane configuration differences, unless these differences have an impact on the procedure or technique being discussed. For example, the FCTM states, "When the flaps are retracted and the airspeed approaches maneuvering speed, ensure CLB thrust is set." This statement is not intended to tell the crew how to set climb thrust, only to emphasize that the flight crew must ensure that CLB thrust is set. It is recognized that crew actions required to set climb thrust are different in different models. Reference to the applicable FCOM is required for information on how to set climb thrust.



737 NG Flight Crew Training Manual

In cases where a procedure or technique is applicable only to an airplane with a specific configuration, the annotation "as installed" is used. Airplane configuration differences are found in the FCOM. In the event of a conflict, the procedures published in the FCOM take precedence over information presented in the FCTM

**Abbreviations**

The following abbreviations may be found throughout the manual. Some abbreviations may also appear in lowercase letters. Abbreviations having very limited use are explained in the chapter where they are used.

A	
ACT	Active
ADF	Automatic Direction Finder
ADI	Attitude Director Indicator
ADIRU	Air Data Inertial Reference Unit
AFDS	Autopilot Flight Director System
AFE	Above Field Elevation
AFM	Airplane Flight Manual (FAA approved)
AFM - DPI	Airplane Flight Manual - Digital Performance Information
AGL	Above Ground Level
AH	Alert Height
ALT ACQ	Altitude Acquire
ALT HOLD	Altitude Hold
AMM	Aircraft Maintenance Manual
ANP	Actual Navigation Performance
A/P	Autopilot
APU	Auxiliary Power Unit

ASA	Autoland Status Annunciator
ASI	Airspeed Indicator
ASR	Airport Surveillance Radar
A/T	Autothrottle
ATC	Air Traffic Control
ATM	Assumed Temperature Method
B	
B/CRS B/C	Back Course
C	
C	Captain Celsius Center
CG	Center of Gravity
CAA/JAA	Civil Aviation Authority/Joint Aviation Authority
CDU	Control Display Unit
CFIT	Controlled Flight Into Terrain
CFP	Computer Flight Plan
CLB	Climb
CON	Continuous

737 NG Flight Crew Training Manual

CRM	Crew Resource Management
CRT	Cathode Ray Tube
CRZ	Cruise
CWS	Control Wheel Steering
D	
D/D	Direct Descent
DDG	Dispatch Deviations Guide
DES	Descent
DA(H)	Decision Altitude (Height)
DIR	Direct
DME	Distance Measuring Equipment
E	
EADI	Electronic Attitude Director Indicator
ECON	Economy
EEC	Electronic Engine Control
EFB	Electronic Flight Bag
EGT	Exhaust Gas Temperature
EHSI	Electronic Horizontal Situation Indicator
EICAS	Engine Indication and Crew Alerting System
ENG OUT	Engine Out
EPR	Engine Pressure Ratio
ETOPS	Extended Range Operation With Twin Engine Airplanes
EXT	Extend
F	

F	Fahrenheit
FCOM	Flight Crew Operations Manual
F/D	Flight Director
FAA	Federal Aviation Administration
FAF	Final Approach Fix
FAR	Federal Aviation Regulation
FCC	Flight Control Computer
FMA	Flight Mode Annunciator
FMC	Flight Management Computer
FMS	Flight Management System
F/O	First Officer
FPA	Flight Path Angle
FPM	Feet Per Minute
FPV	Flight Path Vector
G	
GA	Go-Around
GLS	GPS Landing System
GP	Glide Path
GPS	Global Positioning System
GPWS	Ground Proximity Warning System
G/S	Glide Slope
GS	Ground Speed
H	
HAA	Height Above Airport
HDG SEL	Heading Select

737 NG Flight Crew Training Manual

HSI	Horizontal Situation Indicator
HUD	Head Up Display
I	
IAF	Initial Approach Fix
IAN	Integrated Approach Navigation
IAS	Indicated Airspeed
IFR	Instrument Flight Rules
IGS	Instrument Guidance System
ILS	Instrument Landing System
IM	Inner Marker
IMC	Instrument Meteorological Conditions
IP	Instructor Pilot
IRS	Inertial Reference System
IRU	Inertial Reference Unit
ISFD	Integrated Standby Flight Display
K	
K	Knots
KCAS	Knots Calibrated Airspeed
KGS	Kilograms
KIAS	Knots Indicated Airspeed
L	
LBS	Pounds
LDA	Localizer-type Directional Aid
LNAV	Lateral Navigation

LOC	Localizer
LRC	Long Range Cruise
M	
M	Mach
MAP	Missed Approach Point
MASI	Mach/Airspeed Indicator
MCP	Mode Control Panel
MCT	Maximum Continuous Thrust
MDA(H)	Minimum Descent Altitude (Height)
MEA	Minimum Enroute Altitude
MEL	Minimum Equipment List
MFD	Multifunction Display
MM	Middle Marker
MMO	Maximum Mach Operating Speed
MOCA	Minimum Obstruction Clearance Altitude
MOD	Modify
MORA	Minimum Off Route Altitude
MSL	Mean Sea Level
N	
ND	Navigation Display
NM	Nautical Mile
NNC	Non-Normal Checklist
NNM	Non-Normal Maneuver
NPS	Navigation Performance Scales
O	

OM	Outer Marker
P	
PAPI	Precision Approach Path Indicator
PAR	Precision Approach Radar
PF	Pilot Flying
PFD	Primary Flight Display
PI	Performance Inflight
PIP	Product Improvement Package
PMC	Power Management Control
PM	Pilot Monitoring
Q	
QRH	Quick Reference Handbook
R	
RA	Radio Altitude Resolution Advisory
RAT	Ram Air Turbine
RNV	Area Navigation (RNAV)
RNP	Required Navigation Performance
RSEP	Rudder System Enhancement Program
RTO	Rejected Takeoff
RVR	Runway Visual Range
RVSM	Reduced Vertical Separation Minimum
S	
SAT	Static Air Temperature
SDF	Simplified Directional Facility

SPD	Speed
T	
TAC	Thrust Asymmetry Compensation
TE	Trailing Edge
TA	Traffic Advisory
TACAN	Tactical Air Navigation
TCAS	Traffic Alert and Collision Avoidance System
TO	Takeoff
T/D	Top of Descent
TO/GA	Takeoff /Go-Around
TR	Traffic Resolution
TRK	Track
U	
U.S.	United States
V	
VASI	Visual Approach Slope Indicator
VDP	Visual Descent Point
VEF	Speed at Engine Failure
VFR	Visual Flight Rules
VHF	Very High Frequency
VLOF	Lift Off Speed
VMC	Visual Meteorological Conditions
VMCA	Minimum Control Speed Air
VMCG	Minimum Control Speed Ground
VMO	Maximum Operating Speed

737 NG Flight Crew Training Manual

VNAV	Vertical Navigation
VOR	VHF Omnidirectional Range
VR	Rotation Speed
VREF	Reference Speed
V/S	Vertical Speed
VSI	Vertical Speed Indicator
VSD	Vertical Situation Display
V1	Takeoff Decision Speed
V2	Takeoff Safety Speed
W	
WGS-84	World Geodetic system of 1984
WPT	Waypoint
X	
XTK	Cross Track



Intentionally
Blank

**Revision Record**

No.	Revision Date	Date Filed
Initial	April 1, 1999	
2	October 31, 2002	
4	October 31, 2004	

No.	Revision Date	Date Filed
1	October 31, 2001	
3	October 31, 2003	
5	October 31, 2005	

General

The Boeing Company issues FCTM revisions to provide new or revised recommendations on maneuvers and techniques, or information supporting changes in FCOM procedures. Revisions may also incorporate appropriate information from previously issued Flight Operations Technical Bulletins. Revisions reflect the most current information available to The Boeing Company through the subject revision date.

Formal revisions include a new Revision Record, Revision Highlights, and a current List of Effective Pages. Use the information on the new Revision Record and List of Effective Pages to verify the Flight Crew Training Manual content.

Pages containing revised technical material have revision bars associated with the changed text or illustration. Editorial revisions (for example, spelling corrections) may have revision bars with no associated highlight.

This revised Flight Crew Training Manual is provided in quantities as specified in each operator's contract. Additional copies are available through the Boeing Data and Services Management (DSM) Catalog. The manual is also available in FRAME© format for use in airline modification. Advise if information about FRAME© format is required.

Filing Instructions

This revision is a complete reprint of the FCTM as indicated on the List of Effective Pages (0.5). Remove all old pages and replace all new pages. However, retain all tabs. There are no replacement tabs included with this revision.

Revision Highlights

This section (0.4) replaces the existing section 0.4 in your manual.

This manual is published from a database; the text and illustrations are marked with configuration information. Occasionally, because data base markers are rearranged, or because items are marked with configuration information due to the additions of new database content, some pages may contain revision bars when content appears to be unchanged. Pages may also be republished without revision bars due to slight changes in the flow of the document.

Chapter 1 - General Information

Pilot Area of Responsibility

1.2 - Removed section titled Pilot Area of Responsibility. The information in this section is covered in more detail in the Normal Procedures Introduction section (NP.10) of the FCOM.

Flap Usage

1.3 - Corrected the chapter reference for the "Typical Takeoff Tail Clearance" table.

Maneuver Margins to Stick Shaker

1.5 - Added a bullet to explain that illustrations do not reflect adjustments that are made to maneuver margins for the use of anti-ice.

1.5 - Added a note to clarify that the graphics are for training purposes only.

Callouts

1.19 - Changed the requirement for the PF to acknowledge all GPWS callouts during approach except altitude callouts below "minimums" to below "500 feet AFE". The 500 feet AFE altitude is more compatible with low visibility approach operations.

AFDS Guidelines

1.35 - Modified section title to more accurately indicate that this section contains guidelines rather than procedures.

Crew Action Upon Confirming Pilot Incapacitation

1.38 - Modified the first three bullets for clarity. Removed the double reference to autopilot engagement.

Turbulent Air Penetration

1.38 - Removed reference to setting ignition as directed by the operations manual. Not all engine manufacturers recommend setting ignition in turbulent air. If an ignition setting is recommended, it is listed in the supplementary procedure.

Chapter 2 - Ground Operations

Taxi Speed and Braking

2.4 - Modified thrust required for taxi after the airplane begins to roll forward from "idle thrust" to "thrust as required to maintain normal taxi speed". Although idle thrust is usually sufficient for taxi, conditions such as high gross weight and slope of the taxi surface may require sustained thrust above idle to maintain normal taxi speed.

Turns of 180 Degrees

2.9-11 - Changed "tiller" to "steering wheel" to match FCOM nomenclature.

Taxi - Adverse Weather

2.12 - Added the recommendation to place both engines to idle when completing a turn during taxi on a slippery or contaminated surface. This technique reduces the potential for nose gear skidding, especially during crosswinds and while using differential thrust.

Taxi - One Engine

2.13 - Clarified the Boeing recommendation to start the APU anytime taxi is accomplished with an engine shutdown.

Chapter 3 - Takeoff and Initial Climb

Takeoff Profile

3.2 - Modified the text indicating where autopilot engagement is recommended to address both the normal takeoff and takeoff with one engine inoperative.

Rotation and Liftoff - All Engines

3.7 - Changed the word "adjusted" to "developed" to clarify that there is no adjustment made by the pilot.

3.8 - Removed reference to a takeoff flaps 1 restriction for some airplanes. This note applies to the 737-300 through 737-500 only. All 737-600 through 767-900 and BBJ models are certified for a Flaps 1 takeoff.

Crosswind Takeoff

3.12 - Added "piloted simulation evaluations" to the references used for crosswind guidelines.

Takeoff Crosswind Guidelines

3.12 - Modified explanation of takeoff crosswind guidelines to clarify that proper pilot technique was assumed for dry and slippery runway conditions.

3.12 - Modified the Takeoff Crosswind Guidelines based upon the results of piloted evaluations in an engineering simulator at the Boeing Company. These new guidelines are more consistent with the methods and guidelines used by other Boeing models.

Reduced Thrust Takeoff

3.14 - Added clarification that the reduced thrust takeoff may be done using a combination of the Assumed Temperature Method and a Fixed Derate.

Assumed Temperature Method (ATM)

3.14 - Added an explanation of why the assumed temperature method provides equal to or better performance than if the takeoff was actually done at the assumed temperature.

Fixed Derate

3.15 - Changed reference from an "emergency" to be more specific about when thrust levers may be advanced beyond the fixed derate limit.

Combination Fixed Derate and ATM

3.15 - Added new section to provide information not previously covered in the FCTM.

Improved Climb Performance Takeoff

3.15 - Added that improved climb performance takeoff can be used to increase obstacle limited weights as well as climb limited weights.

Adverse Runway Conditions

3.16 - Modified structure to place the information that should be emphasized in a note. No change made to the text.

Federal Aviation Regulation (FAR) Takeoff Field Length

3.18 - Modified the text to make it clearer and more informative. Added that use of QRH and FMC speeds are not appropriate in all cases.

Rejected Takeoff Maneuver

3.20 - Modified note to accurately describe new chapter titles in the QRH.

3.20 - Removed reference to the first officer callout. The callout is a procedural step.

RTO Execution Operational Margins

3.21 - Removed date for Takeoff Safety Training Aid (TOSA) because not all data is derived from the 1992 version and the TOSA is undergoing revision now.

737 NG Flight Crew Training Manual

3.22-23 - Modified condition descriptions and illustrations to improve clarity. Changed the label "Engine fail" to "Event" because the RTO may be initiated for an event other than an engine fail. These changes will appear in the next revision of the Takeoff Safety Training Aid.

General

3.27 - Removed reference to VMCA. VMCA is not always the limiting factor for minimum control speed in the air.

Rotation and Liftoff - One Engine Inoperative

3.27 - Title changed to more accurately reflect section contents. Section reorganized to more closely parallel the similar section earlier in this chapter titled Rotation and Liftoff - All Engines. Static diagram replaced with a dynamic diagram showing typical pitch attitude and time from start of takeoff at both liftoff and at 35 feet. Added a diagram that shows tail clearance is at a minimum just after liftoff during takeoff. Added tail strike pitch attitude to the table.

Autopilot Engagement - One Engine Inoperative

3.31 - Relocated section to more closely match the sequence of the all engines operating section.

Engine Failure During an ATM Takeoff

3.32 - Section previously titled Engine Failure during Reduced Thrust Takeoff expanded to include information about engine failure during ATM, Fixed Derate, and Combination of ATM and Fixed Derate takeoffs. Provided more specific information about when thrust m

Engine Failure During a Fixed Derate Takeoff

3.33 - Section previously titled Engine Failure during Reduced Thrust Takeoff expanded to include information about engine failure during ATM, Fixed Derate, and Combination of ATM and Fixed Derate takeoffs. Provided more specific information about when thrust m

Engine Failure During a Combined Takeoff

3.33 - Section previously titled Engine Failure during Reduced Thrust Takeoff expanded to include information about engine failure during ATM, Fixed Derate, and Combination of ATM and Fixed Derate takeoffs. Provided more specific information about when thrust m

Chapter 4 - Climb, Cruise, Descent and Holding**Reduced Thrust Climb**

4.1 - Clarified text about overriding the automatically selected climb derate.

Low Altitude Level Off

4.2 - Added some factors that should be considered when a low altitude level off following takeoff with high thrust settings and low gross weight is anticipated.

Economy Climb

4.3 - Modified text to indicate that the use of ECON speed always provides additional cost savings.

Engine Inoperative Climb

4.4 - Modified text to clearly indicate that pitch is adjusted to maintain airspeed regardless of the rate of thrust loss.

Step Climb

4.7 - Removed reference to a "step up" or "step down" step altitude. The step up is the only practical training issue here.

Low Fuel Temperature

4.9 - Added a more specific reference for the location of fuel temperature limitations.

ETOPS

4.13 - Added a more detailed explanation of how critical fuel reserves and other ETOPS planning information are calculated and received by the flight crew.

Descent Preparation Using HUD System

4.13 - Added new section to provide information for airplanes equipped with a HUD system..

Chapter 5 - Approach and Missed Approach

Instrument Approaches

5.1 - Modified the note to place confirmation of the correct alphabetical identifier before aural identification of the navaid. This visual confirmation is the method normally used while aurally identifying the navaid is normally an alternate method.

Approach Category

5.3 - Removed the discussion about Vat and how VREF is determined. This discussion was beyond the purpose of this section. Changed landing mass to landing weight. Landing weight is the standard term used throughout this manual.

737 NG Flight Crew Training Manual

5.3 - Added an explanation of how approach categories are determined and used for the circling approach.

Stabilized Approach Recommendations

5.5 - Modified definition of a stabilize approach for the ILS in accordance with a change to PAA Practical Test Standards. This change allows the crew to accurately interpret the localizer tolerance when the localizer display is in the expanded mode. A full scale/one dot deflection in the expanded mode represents a ¼ scale deflection (1/2 dot) on a normal ILS display.

Mandatory Missed Approach

5.5 - Modified section to indicate that the conditions requiring a missed approach apply only where visual reference with the runway has not been established and is not expected to be maintained. Added expanded information about the RNP based approach.

Approach

5.12 - Removed reference to "INTERCEPT LEG TO".

5.13 - Removed Caution about using LNAV to intercept the final approach course. This information is now provided in paragraph form. A Warning has been added to the Landing Procedure in NP.20 of the FCOM about this potential hazard. An additional step has also been added to the Landing Procedure describing what roll mode may be used to avoid this hazard.

AFDS Autoland Capabilities

5.17 - Modified discussion about vehicle and aircraft operation in ILS critical areas. Deleted specific restrictions used by the airfield controlling agency. Specific requirements for U.S. operations are located in the Air Navigation Aids chapter of the Aeronautical Information Manual.

Non - ILS Instrument Approaches - General

5.33 - Removed reference to "INTERCEPT LEG TO".

5.34 - Clarified use of LNAV relating to fix or radial data displayed on the map.

5.35 - Changed format about ILS approaches coded with threshold crossing height from a note to a paragraph. Most or all ILS approaches have now been coded.

5.35 - Added explanation that the published GP angle refers to the LEGS page.

5.35 - Clarified paragraph that provides examples of approaches that do not have features permitting construction of a normal glide path.

Vertical Path Construction

5.38 - Added a technique that enables the airplane to make a shallower path to the FAF when both the FAF and FACF are coded with "at or above" altitude constraints.

Instrument Approach Using VNAV

5.40 - Moved selection of landing flaps to the point where descent is initiated to DA(H) or MDA(H). This aligns the sequence more closely to the ILS Approach profile and is more fuel efficient than selecting landing flaps in level flight.

5.42 - Diagram relocated from the "Minimum Descent Altitude (MDA (H))/ Decision Altitude (DA(H))" which has been deleted.

5.43 - Modified diagram to match a typical approach procedure.

Instrument Approach Using V/S

5.50 - Moved selection of landing flaps to the point where descent is initiated to MDA(H). This aligns the sequence more closely to the ILS Approach profile and is more fuel efficient than selecting landing flaps in level flight. Changed the title of the position where the missed approach altitude is set from "Approaching MDA(H)" to "Approximately 300 feet above MDA(H)". This should help prevent setting the missed approach altitude after altitude capture. These changes will also be made to the Instrument Approach Using Vertical Speed (V/S) procedure in the Supplementary Procedures section, Vol. 1 of the FCOM and to the Maneuvers section of the QRH.

Minimum Descent Altitude (MDA (H))/ Decision Altitude (DA(H))

5.52 - Deleted section titled "Minimum Descent Altitude (MDA (H))/ Decision Altitude (DA(H))". Most of this information was already contained in the sections titled "Instrument Approach Using VNAV" or "Instrument Approach Using V/S". The diagram illustrating an approach procedure containing DA(H) and MDA(H) minimums moved to the "Instrument Approach Using VNAV" section.

Circling Approach

5.55 - Moved guidance for initiating a missed approach from the normal runway position to a box at the top of the graphic. This change is intended to emphasize that the missed approach can be initiated anytime during the circling maneuver.

5.55 - Changed heading to indicate that actions may be accomplished either before turning base or when initiating the turn to base. Some pilots use the technique of completing configuration changes prior to beginning the base leg. Removed the parenthetical phrase "(if not previously selected)". Selecting landing flaps prior to this point is not recommended.

737 NG Flight Crew Training Manual

Circling Approach - General

5.56 - Modified the circling approach discussion to remove the option of accomplishing the circling maneuver in VNAV ALT (as installed). This avoids the unwanted pitch mode reversion to CWS P when maneuvering for the approach with a higher altitude is set in the MCP. This change will appear in the Supplementary Procedure during the next FCOM revision.

5.56 - Changed text to indicate that actions may be accomplished either before turning base or when initiating the turn to base.

5.56 - Modified note for clarity. The corresponding flight director command bars are affected when a go-around is selected with any flight director switch in the OFF position. As previously written, it appeared that both F/D switches needed to be in the OFF position to affect the command bars.

Circling Approach - One Engine Inoperative

5.57 - Changed text to indicate that actions may be accomplished either before turning base or when initiating the turn to base.

Missed Approach - Circling

5.57 - Clarified the purpose of the initial turn and which missed approach procedure is flown.

Touch and Go Landings

5.62 - Modified the Entering Downwind block to do the "Descent" checklist instead of the "Approach" checklist. The NC has been revised to include a Descent checklist and these items are appropriate entering downwind. Modified the Stabilized on Downwind block to do the "Approach" checklist instead of the "Recheck VREF" step. VREF is checked during the Descent checklist.

Go-Around and Missed Approach - All Engines Operating

5.67 - Added the option of selecting VNAV when the flaps are up. This matches the revised normal procedure.

Go-Around after Touchdown

5.67 - Section relocated here from Chapter 6. Section reorganized for clarity. Removed the technique used by some operators of selecting 500 feet as the commit point. The FCTM normally provides one technique although it is recognized that other techniques may be used by operators.

Chapter 6 - Landing**Non-Normal Landing Distance**

6.2 - Added specific location for non-normal configuration landing distance.

VASI Landing Geometry

6.5 - Modified title because this section provides two bar VASI landing geometry only.

Rejected Landing

6.11 - Moved section titled Go-Around after Touchdown to the Go-Around section in Chapter 5. Added a new section titled Rejected Landing.

Landing Roll

6.22 - Modified title for simplicity.

Reverse Thrust Operation

6.32 - Modified instruction after the reverser interlock releases for clarity.

Landing Crosswind Guidelines

6.34 - Modified explanation of landing crosswind guidelines to clarify that airplane loading is not a variable used when entering the table.

Overweight Landing

6.36 - Modified the description of where the landing distance charts are located to be more specific.

Chapter 7 - Maneuvers

Preface

7.1 - Modified to provide more accurately describe chapter contents. Added general guidance when maneuvering results in deviation from the ATC clearance.

Engine Out Familiarization

7.2 - Removed reference to VMCA. VMCA is not always the limiting factor for minimum control speed in the air.

Rapid Descent

7.5 - Added information about the possible need for special planning or company procedures for routes flown over mountainous terrain.

7.5 - Added the word "normally" to the note. The rapid descent can be done with the gear down as described in the new section titled Landing Gear Extended Descent.

7.6 - Modified text to indicate that a reduction to turbulent air penetration speed is only required when severe turbulent air is encountered.

737 NG Flight Crew Training Manual

Landing Gear Extended Descent

7.7 - New section added to address a rapid descent when airspeed must be limited due to structural integrity.

Rollout

7.22 - Added more specific information about adjusting pitch and thrust during rollout.

Traffic Advisory (TA)

7.23 - Added the goal of the TA as described in ICAO regulations.

Resolution Advisory (RA)

7.23 - Added "particularly at night" to the sentence describing that visual perception of an RA encounter can be misleading.

7.23 - Removed the note that indicated visual acquisition of a target is reason to not comply with an RA command. As stated, this note was possibly in conflict with current regulatory guidance. The subject of visual acquisition is discussed in the first paragraph of this section.

General

7.27 - Removed specific AFM load factor limit. The crew has no flight deck indication showing actual load factor.

Chapter 8 - Non-Normal Operations

Troubleshooting

8.2 - Added new section to emphasize the Boeing recommended policy on troubleshooting.

Approach and Landing

8.3 - Added an explanation about why autobrakes are recommended during approach and landing unless precluded by the NNC.

8.3 - Modified last sentence for clarity.

Air Systems

8.4 - New section added to help make crews more aware of crew caused cabin altitude warning alerts and confusion about what caused the alert.

Approach and Landing on Standby Power

8.6 - Changed reference to normal approach procedures because an approach on standby power requires actions beyond those required on a normal approach.

8.6 - Clarified that the list of equipment powered by standby power is not all inclusive. Only significant items are included.

Engine Failure vs Engine Fire After Takeoff

8.6 - Removed the first sentence. Engine failure due to severe damage or separation could be interpreted as a failure requiring recall NNC items.

Loss of Thrust on Both Engines

8.8 - Changed "driftdown" to "descent" to avoid any implication that the engine inoperative driftdown discussion in chapter 4 was applicable in this situation.

Discharging Fire Bottles during an Evacuation

8.10 - Added new section with considerations regarding the discharge of fire bottles while accomplishing the Evacuation NNC. An evacuation can be conducted for many different events, not all of which can be fully explained in the NNC.

Stabilizer Trim Inoperative

8.15 - Modified title to match the revised NNC title.

8.15 - Modified section to removed information duplicated in the NNC, to include additional reasons why a stabilizer may become inoperative, and to explain consequences of each failure mode.

Fuel Balance

8.19 - Removed note that indicated fuel balancing should be terminated prior to final approach. This restriction has been removed from the AFM.

Partial or Gear Up Landing

8.23 - Section extensively rewritten to remove steps that are not supported by the NNC and those that are adequately described in the NNC, provide more general techniques for approach and landing, add specific recommendations on where to touchdown for applicable gear malfunctions, standardization across all models where applicable, and improve the clarity of the section.

8.24 - Added new section to explain why the NNC specifies how and when the speedbrakes are to be used.

8.24 - Added new section to explain why the NNC specifies when reverse thrust is to be used.

8.25 - Removed reference to placing the start lever to OFF when landing with one main gear only extended. This action is not supported by the NNC.

Overspeed

8.25 - Modified section to incorporate information from 777 Flight Operations Tech Bulletin #11 dated December 2002. The information in this section applies to all models, but more frequently to those models that normally operate near VMO/MMO.



Page	Date
FCTM	
* Title Page	October 31, 2005
* Copyright	October 31, 2005
* 0.0.1-2	October 31, 2005
* 0.1.1-2	October 31, 2005
* 0.2.1-2	October 31, 2005
* 0.3.1-6	October 31, 2005
Revision Record (tab)	
* 0.4.1-12	October 31, 2005
* 0.5.1-2	October 31, 2005
General Information (tab)	
* 1.TOC.1-4	October 31, 2005
* 1.1-40	October 31, 2005
Ground Operations (tab)	
* 2.TOC.1-2	October 31, 2005
* 2.1-14	October 31, 2005
Takeoff, Initial Climb (tab)	
* 3.TOC.1-2	October 31, 2005
* 3.1-34	October 31, 2005
Climb, Cruise, Descent, Holding (tab)	
* 4.TOC.1-2	October 31, 2005
* 4.1-22	October 31, 2005
Approach, Missed Approach (tab)	
* 5.TOC.1-4	October 31, 2005
* 5.1-68	October 31, 2005
Landing (tab)	
* 6.TOC.1-2	October 31, 2005
* 6.1-38	October 31, 2005

Page	Date
Maneuvers (tab)	
* 7.TOC.1-2	October 31, 2005
* 7.1-30	October 31, 2005
Non-Normal Operations (tab)	
* 8.TOC.1-4	October 31, 2005
* 8.1-34	October 31, 2005
Index (tab)	
* Index.1-8	October 31, 2005
(blank tab)	

* = Revised, Added, or Deleted

Copyright © The Boeing Company. See title page for details.

Intentionally
Blank



Preface 1.1

Operational Philosophy 1.1

 Events Requiring Maintenance Inspection 1.1

Training Objectives 1.2

Qualification Requirements (Checkride) 1.2

 Evaluation 1.2

Crew Resource Management (CRM) 1.2

Headphone and Flight Deck Speaker Use 1.3

Flap Usage 1.3

 Flap - Speed Schedule/Maneuvering Speeds 1.3

 Maneuver Margins to Stick Shaker 1.5

 Flap Operation 1.14

Command Speed 1.15

 Takeoff 1.15

 Climb, Cruise and Descent 1.15

 Approach 1.15

 Landing 1.15

 Non-Normal Conditions 1.16

Reference Bugs 1.17

 Bug Setting (MASI or PFD/ND) 1.17

Callouts 1.19

 Standard Callouts 1.20

 Standard Phraseology 1.23

Electronic Flight Bag (EFB)	1.24
Airport Moving Map	1.24
Terminal Charts	1.25
Airplane Performance	1.25
Video Surveillance	1.25
Electronic Logbook and Other Documents	1.25
Flight Path Vector (FPV)	1.25
Cold Temperature Altitude Corrections	1.26
Operation in Icing Conditions	1.27
Training Flights	1.27
Recommended Rudder Trim Technique	1.28
Drag Factors Due to Trim Technique	1.28
Primary Rudder Trim Technique	1.28
Alternate Rudder Trim Technique	1.29
Flight Management Computer(s)/CDUs	1.30
FMC Route Verification Techniques	1.30
FMC Performance Predictions - Non-Normal Configuration	1.30
RNP and RNAV Operations	1.31
Basic RNP Concept	1.31
RNAV Operations: En-route, Terminal, and Approach	1.33
GPS Use in Non-WGS-84 Reference Datum Airspace	1.34
Weather Radar and Terrain Display Policy	1.35
AFDS Guidelines	1.35
Autothrottle Use	1.35
Manual Flight	1.36



737 NG Flight Crew Training Manual

Automatic Flight	1.36
Pilot Incapacitation	1.37
Crew Action Upon Confirming Pilot Incapacitation	1.38
Turbulent Air Penetration	1.38

Intentionally
Blank



Preface

This chapter outlines Boeing operational policies used during training. Recommended procedures for Crew Coordination, Flap/Speed Schedule, Thrust Management, Turbulent Air Penetration, and Crew Resource Management are covered. This provides a basis for standardization. Conditions beyond the control of the flight crew may preclude following a maneuver exactly. The maneuvers are not intended to replace good judgment and logic.

Operational Philosophy

The normal procedures are designed for use by trained flight crewmembers. The procedure sequence follows a definitive panel scan pattern. Each crewmember is assigned a flight deck area to initiate action in accordance with Normal and Supplementary Procedures. Non-normal procedural actions and actions outside the crewmembers' area of responsibility are initiated at the direction of the captain.

Non-normal checklists are provided to cope with or resolve non-normal situations on the ground or in flight.

Supplementary Procedures are accomplished as required rather than on each flight sector. They are not included in the Quick Reference Handbook (QRH).

Events Requiring Maintenance Inspection

During ground or flight operations, events may occur which require a maintenance inspection after flight. Most operators have established a procedure/policy to ensure that aircrews document these events so that proper maintenance can take place.

Chapter 5 of the Aircraft Maintenance Manual (AMM) refers to such events as "Conditional Inspections". These include, but are not limited to:

- hard landing
- severe turbulence
- (landing gear, flap/slat, MMO/VMO) overspeed
- high-energy stop (refer to the AMM for guidance)
- lightning strike
- extreme dust
- tail strike
- overweight landing

Additional events, that are not listed in chapter 5 but may require maintenance inspection, should also be reported. An example of such an event is an overly aggressive pitch up during a TCAS event or a Terrain Avoidance maneuver that could cause structural damage. If in doubt, the best course of action is to report it.

Training Objectives

The flight-training program prepares the student for airplane qualification and/or the FAA rating checkride (or equivalent). Flight safety, passenger comfort and operational efficiency are emphasized.

Qualification Requirements (Checkride)

Following satisfactory completion of transition training and when recommended by an authorized instructor, each pilot must satisfactorily demonstrate the ability to perform maneuvers and procedures prescribed in FAA or other applicable governing regulations. Throughout the prescribed maneuvers, command ability and good judgment commensurate with a high level of safety must be demonstrated. In determining whether such judgment has been shown, the evaluator considers adherence to approved procedures, actions based on the analysis of situations, and care and prudence in selecting the course of action.

Evaluation

An evaluation may be given at the end of simulator training. The content of the evaluation varies with the capabilities of the simulator used and the requirements of the governing regulatory agency.

An evaluation in the airplane may be required if the training has not been accomplished under the prescribed requirements of FAA or other applicable governing regulations.

Crew Resource Management (CRM)

Crew resource management is the application of team management concepts and the effective use of all available resources to operate a flight safely. In addition to the aircrew, it includes all other groups routinely working with the aircrew who are involved in decisions required to operate a flight. These groups include, but are not limited to, airplane dispatchers, flight attendants, maintenance personnel, and air traffic controllers.

Throughout this manual, techniques that help build good CRM habit patterns on the flight deck are discussed. For example, situational awareness and communications are stressed. Situational awareness, or the ability to accurately perceive what is going on in the flight deck and outside the airplane, requires on going questioning, crosschecking, communication, and refinement of perception.

737 NG Flight Crew Training Manual

It is important that all flight deck crewmembers identify and communicate any situation that appears unsafe or out of the ordinary. Experience has proven that the most effective way to maintain safety of flight and resolve these situations is to combine the skills and experience of all crewmembers in the decision making process to determine the safest course of action.

Headphone and Flight Deck Speaker Use

In the airplane, headphones or boom microphones/headsets are worn during takeoff until the top of climb and from the start of descent throughout approach and landing. During cruise, flight deck speakers may be used. Speaker volume should be kept at the minimum usable level adequate to avoid interference with normal crew flight deck conversation, but still assure reception of relevant communications.

Flap Usage

For takeoffs, when conditions permit, consider using larger flap settings to provide shorter takeoff distance. Refer to the Typical Takeoff Tail Clearance table, chapter 3, to determine minimum tail clearance for different takeoff flap settings.

During maneuvering for an approach, when the situation dictates an earlier than normal speed reduction, the use of flaps 10 with the gear up is acceptable.

For normal landings, use flaps 30. When required, use flaps 40 to minimize landing speed and landing distance.

Flap - Speed Schedule/Maneuvering Speeds

The flap maneuvering speed schedule provides the recommended maneuvering speed for various flap settings. When recommended maneuvering speeds are followed, the schedule provides margin to stick shaker for at least an inadvertent 15° overshoot beyond the normal 25° angle of bank.

The schedule provides speeds that are close to minimum drag and in climb are close to maximum angle of climb speed. In level flight it provides relatively constant pitch attitudes and requires little change in thrust at different flap settings.

Flap Maneuvering Speed Schedule

The flap maneuvering speed schedule is based upon VREF 40 and provides adequate maneuver margin to stick shaker at all weights.

Flap Position	All Weights
Flaps UP	VREF 40 + 70
Flaps 1	VREF 40 + 50
Flaps 5	VREF 40 + 30



737 NG Flight Crew Training Manual

Flap Position	All Weights
Flaps 10	VREF 40 + 30
Flaps 15	VREF 40 + 20
Flaps 25	VREF 40 + 10
Flaps 30	VREF 30
Flaps 40	VREF 40

During flap retraction/extension, selecting the next flap setting should be initiated when reaching the maneuver speed for the existing flap position. The airplane should be accelerating when flaps are retracting to the next position. Adequate maneuver margin is retained at a speed 20 knots below the recommended speed for all bank angles up to 30°. During flap extension, selection of the flaps to the next position should be made prior to decelerating below the recommended flap speed for the current flap setting.

The maneuver speed for the existing flap position is indicated by the numbered flap maneuvering speed bugs.

Maneuver Margins to Stick Shaker

The following figures illustrate airplane maneuvering capability or margin to stick shaker as a function of airspeed. This includes an engine inoperative departure scenario (Takeoff) and an all engine approach scenario (Landing).

When reviewing the maneuver margin illustrations, note that:

- there is a direct correlation between bank angle and load factor (G's) in level, constant speed flight. For example, 1.1G corresponds to 25° of bank, 1.3G ~ 40°, 2.0G's ~ 60°
- the illustrated bank maneuver capability assumes a constant speed, level flight condition
- stick shaker activates prior to actual stall speed
- the bold line designates flap configuration changes at the scheduled flap transition speeds
- maneuver margins are based upon basic stick shaker schedules and do not include adjustments for the use of anti-ice.

The distance between the bold line representing the flap retraction (Takeoff) or extension schedule (Landing) and a given bank angle represents the maneuver margin between stick shaker and the flap schedule for level constant speed flight. Where the flap extension/retraction schedule extends below a depicted bank angle, stick shaker activation can be expected prior to reaching that bank angle.

The takeoff figures assume a single engine climbout and takes into account the vertical component of the thrust vector of one engine at full power. These figures are an example of a heavy weight, sea level standard day condition. The unshaded region of the chart represents the area within the certified structural load factor for flaps down operation.

Note: The Maneuver Margins to Stick Shaker figures are to be used for training purposes only. This data is not suitable for engineering analysis.

Maneuver Margins to Stick Shaker Takeoff

737-600

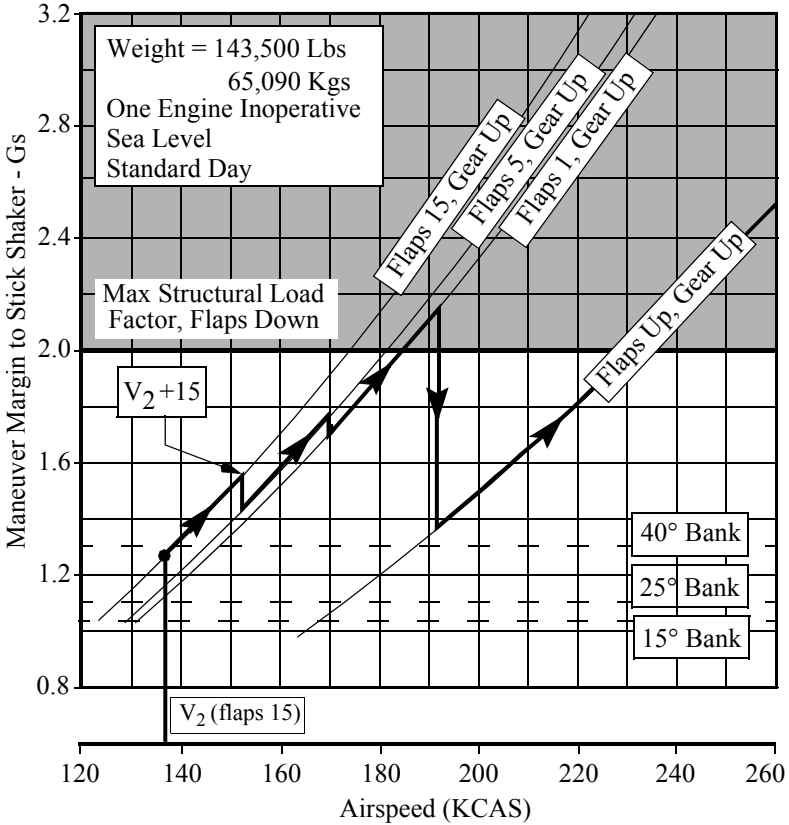

737 NG Flight Crew Training Manual

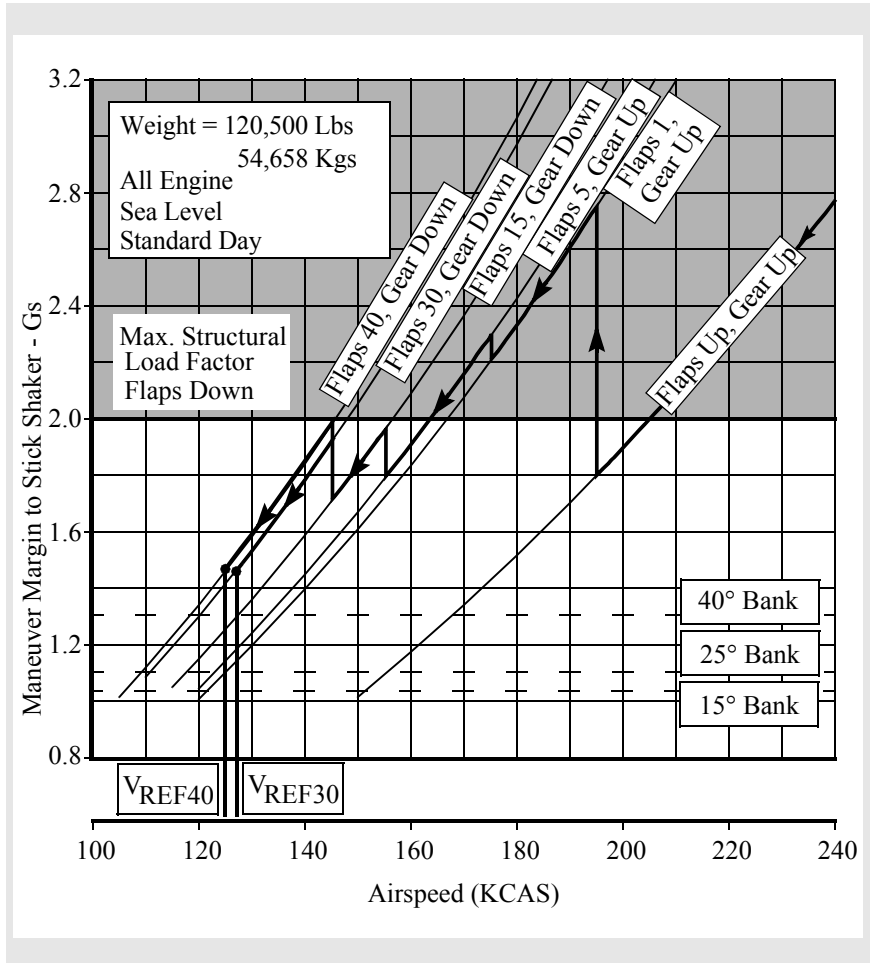
Maneuver Margins to Stick Shaker Landing
737-600

Maneuver Margins to Stick Shaker Takeoff

737-700

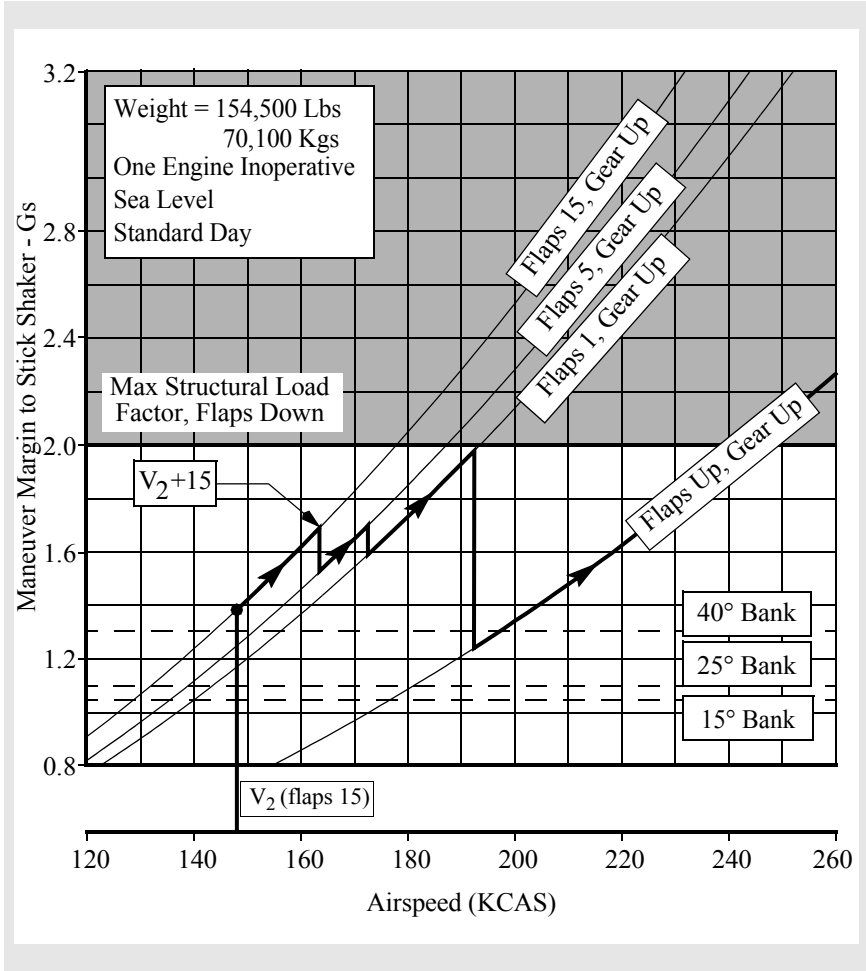

737 NG Flight Crew Training Manual

Maneuver Margins to Stick Shaker Landing
737-700

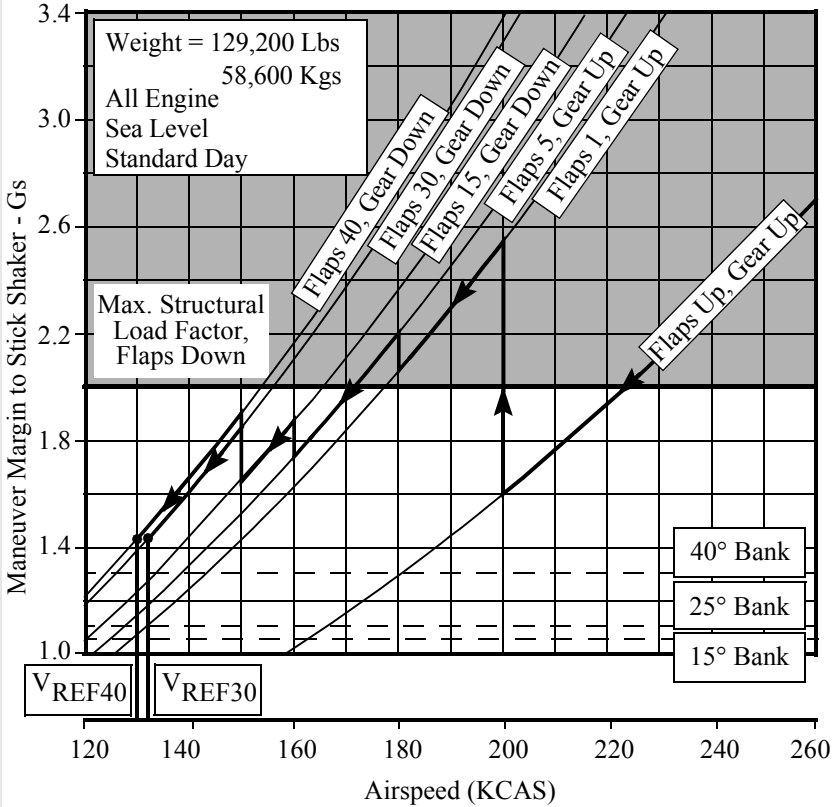

Maneuver Margins to Stick Shaker Takeoff

737-800

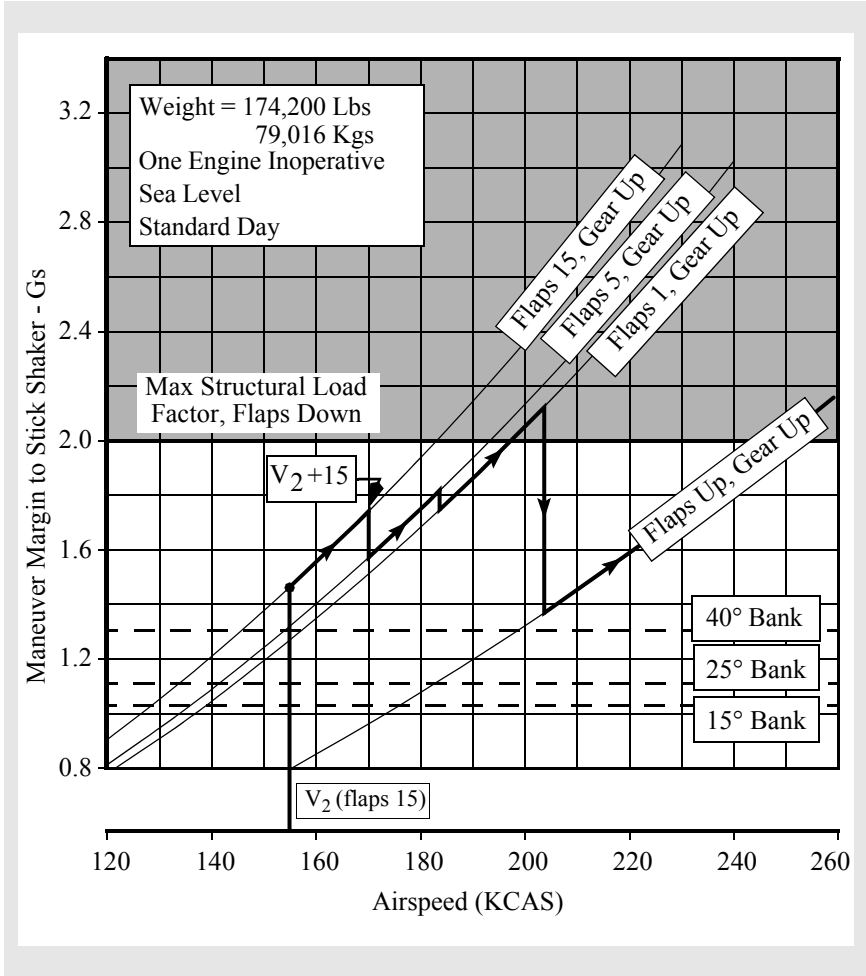

737 NG Flight Crew Training Manual

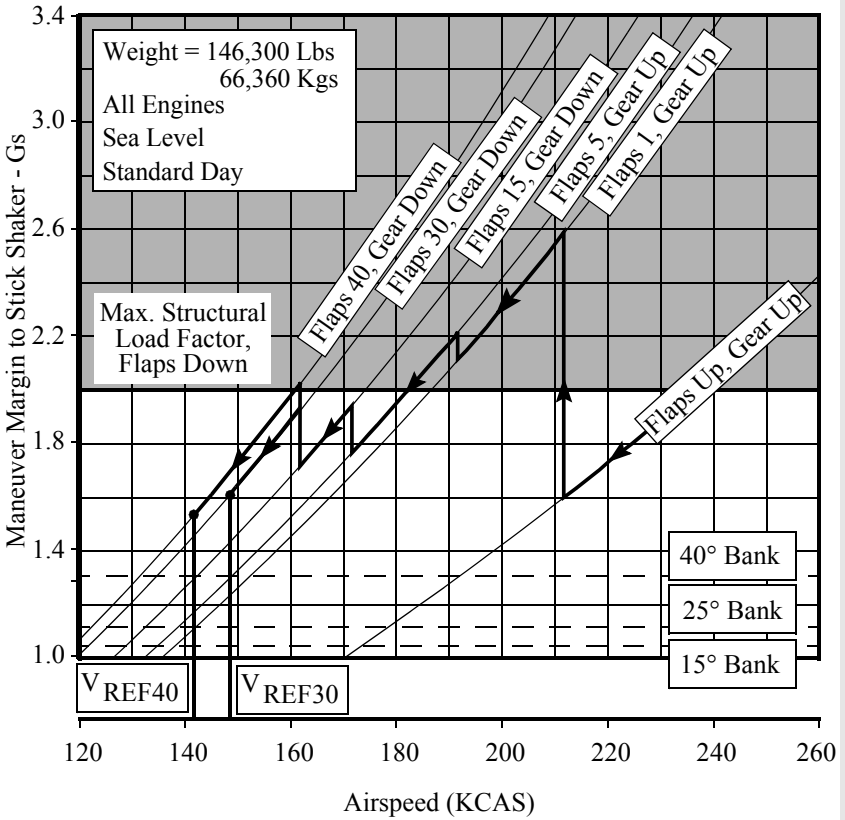
Maneuver Margins to Stick Shaker Landing
737-800

Maneuver Margins to Stick Shaker Takeoff

737-900

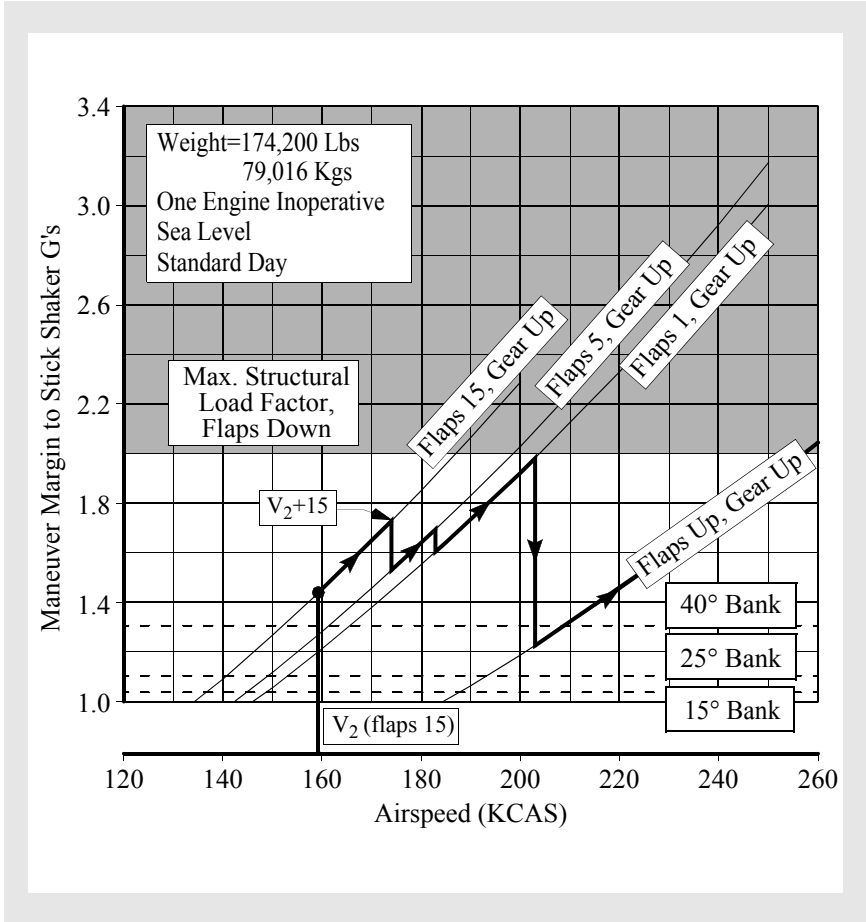

737 NG Flight Crew Training Manual

Maneuver Margins to Stick Shaker Landing

737-900

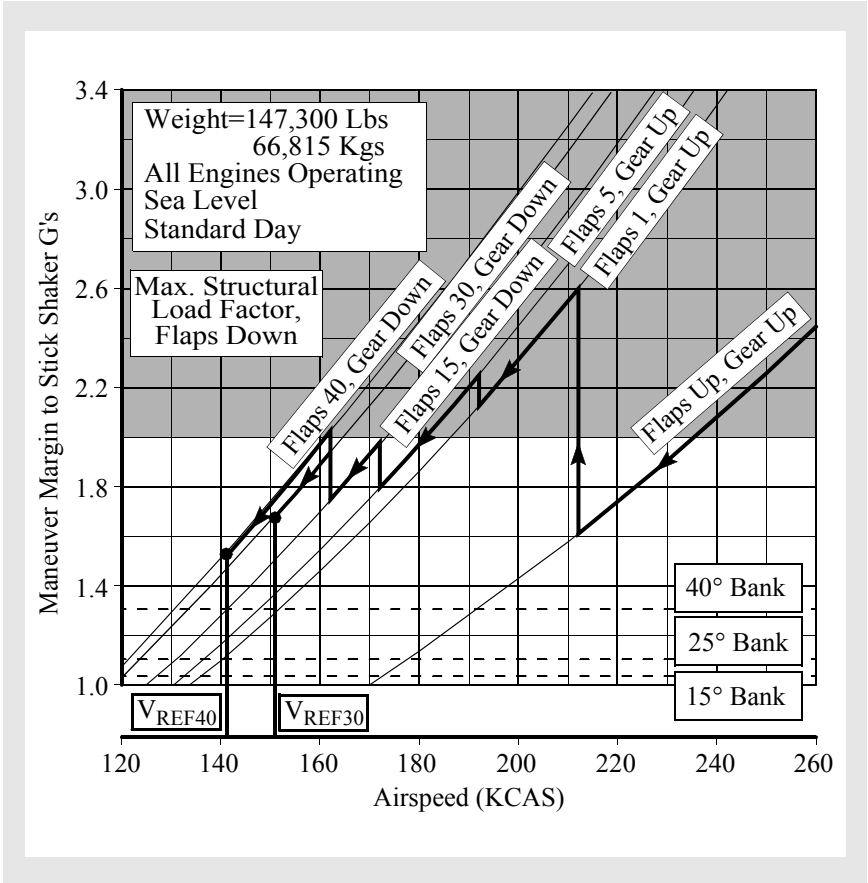

Flap Operation

Acceleration Height - All Engines

The altitude selected for acceleration and flap retraction may be specified for each airport. Safety, obstruction clearance, airplane performance or noise abatement requirements are usually the determining factors. Some operators have adopted a standard climb profile for all of their operations based on the airport which requires the greatest height for level off to clear a close-in obstacle with an engine failure.

The minimum altitude for flap retraction is 400 feet. Boeing recommends 1000 feet for the standard flap retraction altitude used in training.

Acceleration Height - Engine Out

Acceleration height for a takeoff with an engine failure after V1 is based on accelerating to the recommended flaps up speed while retracting flaps and selecting maximum continuous thrust limits within 5 minutes (10 minutes optional) after initiating takeoff. Some combinations of high gross weight, takeoff flap selection and airport elevation may require initiating flap retraction as low as 400 feet after takeoff with an engine failure.

At typical training weights, adequate performance exists to climb to 1000 feet before beginning flap retraction. Therefore, during training, 1000 feet is used as the acceleration height for engine failure after V1.

Command Speed

Command speed may be set by the pilot through the MCP or FMC and is displayed by a magenta airspeed cursor on the airspeed indicator or by a magenta speed bug on the PFD airspeed display.

Takeoff

Command speed remains set at V_2 until changed by the pilot for acceleration and flap retraction. Manually select flaps up maneuver speed at flap retraction altitude.

Climb, Cruise and Descent

Command speed is set to the appropriate speed by the FMC during VNAV operation or manually using the MCP. The white airspeed bugs (if installed) are positioned to the appropriate airspeeds for approach and landing.

Approach

Command speed is set to the maneuvering speed for the selected flap position by the FMC during VNAV operation or manually using the MCP.

Landing

When using the autothrottle, position command speed to $V_{REF} + 5$ knots. Sufficient wind and gust protection is available with the autothrottle engaged because the autothrottle is designed to adjust thrust rapidly when the airspeed drops below command speed while reducing thrust slowly when the airspeed exceeds command speed. In turbulence, the result is that average thrust is higher than necessary to maintain command speed. This results in an average speed exceeding command speed.

If the autothrottle is disengaged, or is planned to be disengaged prior to landing, the recommended method for approach speed correction is to add one half of the reported steady headwind component plus the full gust increment above the steady wind to the reference speed. One half of the reported steady headwind component can be estimated by using 50% for a direct headwind, 35% for a 45° crosswind, zero for a direct crosswind and interpolation in between.

When making adjustments for wind additives, the maximum command speed should not exceed $V_{REF} + 20$ knots or landing flap placard speed minus 5 knots, whichever is lower. This technique provides sufficient low speed maneuver margin and reduces the possibility of flap load relief activation. Margin to load relief activation may also be increased by using a reduced landing flap setting. The following table shows examples of wind additives with a runway heading of 360° .



737 NG Flight Crew Training Manual

Reported Winds	Wind Additive	Approach Speed
360 at 16	8	VREF + 8 knots
Calm	0	VREF + 5 knots
360 at 20 Gust 30	10 + 10	VREF + 20 knots*
060 at 24	6	VREF + 6 knots
090 at 15	0	VREF + 5 knots
090 at 15 Gust 25	0 + 10	VREF + 10 knots

* If VREF + 20 exceeds landing flap placard speed minus 5 knots, use landing flap placard speed minus 5 knots.

The minimum command speed setting with autothrottle disconnected is VREF + 5 knots. The gust correction should be maintained to touchdown while the steady headwind correction should be bled off as the airplane approaches touchdown.

Note: Do not apply wind corrections for tailwinds. Set command speed at VREF + 5 knots (autothrottle engaged or disconnected).

Non-Normal Conditions

Occasionally, a non-normal checklist instructs the flight crew to use a VREF speed that also includes a speed additive such as VREF 15 + 15. When VREF has been adjusted by the non-normal procedure, the new VREF is called the adjusted VREF and becomes the new VREF for landing (adjusted VREF does not include wind corrections). For example, if a non-normal checklist specifies “Use flaps 15 and VREF 15 + 10 for landing”, the flight crew would select flaps 15 as the landing flaps and look up the VREF 15 speed in the FMC or QRH and add 10 knots to that speed.

If the autothrottle is disengaged, or is planned to be disengaged prior to landing, appropriate wind corrections must be added to the adjusted VREF to arrive at command speed, the speed used to fly the approach. For example, if the checklist states “use VREF 40 + 30 knots”, command speed should be positioned to adjusted VREF (VREF 40 + 30) + wind correction (5 knots minimum, 20 knots maximum).

If a flaps 15 landing is performed and VREF ICE is required, (VREF ICE = VREF 15 + 10), the wind correction should not exceed 10 knots.

737 NG Flight Crew Training Manual

Reference Bugs

The following figure shows the positioning of the reference bugs on the airspeed indicator for takeoff and approach.

Bug Setting (MASI or PFD/ND)

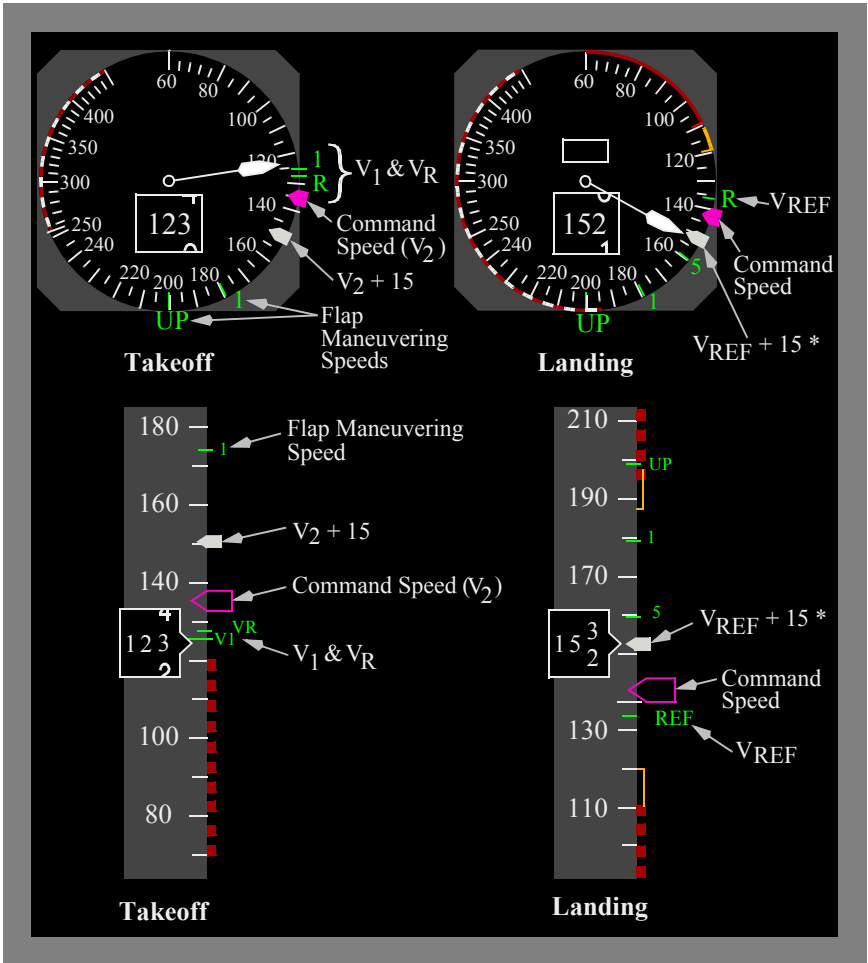

737-800, 737-900

* $V_{REF} + 20$ with CDS Block Point 2004 and later. Refer to the FCOM for correct configuration.

Takeoff

When V1, VR and gross weight are entered into the FMC, airspeed bugs are automatically displayed at V1, VR and the minimum flap retraction speed for the next flap position. Command speed is set at V2 using the MCP. V2 is the minimum takeoff safety speed and provides at least 30° bank capability (15° + 15° overshoot) for all takeoff flaps. An airspeed bug is automatically set 15 knots above command speed. V2 + 15 provides 40° bank capability (25° + 15° overshoot) for all takeoff flaps.

Approach - Landing

737-600, 737-700

VREF and VREF + 15 are displayed upon entry of landing flaps/speed in the FMC. The maneuvering speed for the current flap position and the next flap position are automatically displayed on the airspeed display.

737-800, 737-900

VREF and VREF + 15 (VREF + 20 for airplanes with CDS Block Point 2004 and later) are displayed upon entry of landing flaps/speed in the FMC. The maneuvering speed for the current flap position and the next flap position are automatically displayed on the airspeed display.

Bug Setting with FMC Inoperative

With FMC inoperative, the speed reference selector is used to set V1, VR and VREF. Refer to the FCOM, Section SP.10, for details.

Callouts

Both crewmembers should be aware of altitude, airplane position and situation.

Avoid nonessential conversation during critical phases of flight, particularly during taxi, takeoff, approach and landing. Unnecessary conversation reduces crew efficiency and alertness and is not recommended when below 10,000 feet MSL / FL100. At high altitude airports, adjust this altitude upward, as required.

The Pilot Monitoring (PM) makes callouts based on instrument indications or observations for the appropriate condition. The Pilot Flying (PF) should verify the condition/location from the flight instruments and acknowledge. If the PM does not make the required callout, the PF should make it.

The PM calls out significant deviations from command airspeed or flight path. Either pilot should call out any abnormal indications of the flight instruments (flags, loss of deviation pointers, etc.).

One of the basic fundamentals of Crew Resource Management is that each crewmember must be able to supplement or act as a back-up for the other crewmember. Proper adherence to standard callouts is an essential element of a well-managed flight deck. These callouts provide both crewmembers required information about airplane systems and about the participation of the other crewmember. The absence of a standard callout at the appropriate time may indicate a malfunction of an airplane system or indication, or indicate the possibility of incapacitation of the other pilot.

The PF should acknowledge all GPWS voice callouts during approach except altitude callouts while below 500 feet AFE. The standard callout of "CONTINUE" or "GO-AROUND" at minimums is not considered an altitude callout and should always be made. If the automatic electronic voice callout is not heard by the flight crew, the PM should make the callout.

Note: If automatic callouts are not available, the PM may call out radio altitude at 100 feet, 50 feet and 30 feet (or other values as required) to aid in developing an awareness of eye height at touchdown.



Standard Callouts

	CONDITION / LOCATION	CALLOUT (Pilot Monitoring, unless noted)
Climb And Descent	Approaching Transition Altitude/Transition Level	“TRANSITION ALTITUDE/ LEVEL, ALTIMETERS RESET _____” (in. or mb)
	1000 ft. above/below assigned altitude/Flight Level (IFR)	“1000 FT TO LEVEL OFF”
Descent	10,000 ft. MSL / FL100 (Reduce airspeed if required) (IFR and VFR)	“10,000 / FL100”

737 NG Flight Crew Training Manual
Standard Callouts - ILS Approach

CONDITION / LOCATION	CALLOUT (Pilot Monitoring, unless noted)
First positive inward motion of localizer pointer	"LOCALIZER ALIVE"
First positive motion of Glide Slope pointer	"GLIDE SLOPE ALIVE"
Final approach fix inbound	"OUTER MARKER/FIX, ____ FT"
500 ft. AFE (Check autoland status annunciator, if applicable)	"500 FEET" (F/D or single autopilot approach) Autoland status "FLARE ARMED" (Autoland callout only) Autoland status "LAND 2 or LAND 3 or NO AUTOLAND"
100 ft. above DA(H) (fail passive airplanes)	"APPROACHING MINIMUMS"
Individual sequence flasher lights visible	"STROBE LIGHTS"
At AH (fail operational airplanes) - check autoland status annunciator	"ALERT HEIGHT"
At DA(H) with individual approach light bars visible	"MINIMUMS - APPROACH LIGHTS / RED BARS" (if installed)
At DA(H) - Suitable visual reference established, i.e., PM calls visual cues	PF: "CONTINUE"
At DA(H) - Suitable visual reference not established, i.e., PM does not call any visual cues or only strobe lights	PF: "GO AROUND"
At minimums callout - If no response from PF	"I HAVE CONTROL ____" (state intentions)
Below DA(H) - Suitable visual reference established	"THRESHOLD/RUNWAY TOUCHDOWN ZONE"
Below DA(H) - Suitable visual reference established	PF: "LANDING"
Below DA(H) - Suitable visual reference not established, i.e., PM does not call any visual cues	PF: "GO AROUND"



Standard Callouts - Non-ILS Approach

CONDITION / LOCATION	CALLOUT (Pilot Monitoring, unless noted)
First positive inward motion of VOR or LOC course deviation indication	"COURSE/LOCALIZER ALIVE"
Final approach fix inbound	"VOR/NDB/FIX"
500 ft. AFE	"500 FEET"
100 ft. above DA(H) or MDA(H)	"APPROACHING MINIMUMS"
Individual sequence flasher lights visible	"STROBE LIGHTS"
At DA(H) or MDA(H) with individual approach light bars visible	"MINIMUMS - APPROACH LIGHTS / RED BARS" (if installed)
At DA(H) or MDA(H) - Suitable visual reference established, i.e., PM calls visual cues	PF: "CONTINUE"
At DA(H) or MDA(H)- Suitable visual reference not established, i.e., PM does not call any visual cues or only strobe lights	PF: "GO AROUND"
At minimums callout - If no response from PF	"I HAVE CONTROL _____" (state intentions)
Below DA(H) or MDA(H)- Suitable visual reference established	"THRESHOLD/RUNWAY TOUCHDOWN ZONE"
Below DA(H) or MDA(H)- Suitable visual reference established	PF: "LANDING"
Below DA (H) or MDA(H)- Suitable visual reference not established, i.e., PM does not call any visual cues	PF: "GO AROUND"

Standard Phraseology

A partial list of recommended words and phrases follows:

Thrust:

- “SET TAKEOFF THRUST”
- “SET GO-AROUND THRUST”
- “SET MAXIMUM CONTINUOUS THRUST”
- “SET CLIMB THRUST”
- “SET CRUISE THRUST”

Flap Settings:

- “FLAPS UP”
- “FLAPS ONE”
- “FLAPS FIVE”
- “FLAPS TEN”
- “FLAPS FIFTEEN”
- “FLAPS TWENTY-FIVE”
- “FLAPS THIRTY”
- “FLAPS FORTY”

Airspeed:

- “80 KNOTS”
- “V1”
- “ROTATE”
- “SET _____ KNOTS”
- “SET VREF PLUS (additive)”
- “SET FLAPS _____ SPEED”

Electronic Flight Bag (EFB)

This section provides guidance on the use of the optional Electronic Flight Bag (EFB).

Airport Moving Map

The airport map display is intended to enhance crew positional awareness while planning taxi routes and while taxiing. The system is not intended to replace normal taxi methods including the use of direct visual observation of the taxiways, runways, airport signs and markings and other airport traffic. Prior to taxi, NOTAMS and airport charts (using EFB terminal charts or paper) should be consulted for the latest airport status to include closed taxiways, runways, construction, etc., since these temporary conditions are not shown on the airport map.

Note: Crews must avoid fixation on the display or distraction from primary crew duties while using any EFB application.

Crews must use direct visual observation out flight deck windows as the primary taxi navigation reference. Use the airport Heading-Up or North-Up map to provide enhanced positional awareness by:

- verifying taxi clearance and assisting in determining taxi plan (both pilots)
- monitoring taxi progress and direction (both pilots)
- alerting and updating the pilot taxiing with present position and upcoming turns and required stops (pilot not taxiing).

In flight, the airport North-Up (fixed) fixed map may be used to aid in runway exit planning and anticipating the taxi route to the gate or parking spot.

If one airport map display is inoperative at dispatch, the crewmember with the inoperative display may wish to keep a paper copy of the airport diagram readily available. During taxi in this situation, one pilot should continue to use the airport map display for positional awareness while the other pilot monitors progress on the paper chart. If an airport map display fails after dispatch and no paper backup airport diagrams are available, the crew should consider having the pilot not taxiing provide progressive taxi and positional updates to the pilot taxiing or request progressive taxi instruction from ground control. In any case, the pilot taxiing should always devote primary attention to taxiing the airplane by external visual observation. If the airport map display is inoperative on both sides, use normal taxi procedures.

Note: GPS position must be available to use the Heading-Up map.

Terminal Charts

Electronic terminal charts may be used in place of paper charts. Enroute charts are not available in the EFB at this time. Should the airplane dispatch with one or both displays inoperative, the crew should comply with the provisions of the MEL regarding the use of backup charts.

Airplane Performance

When all appropriate entries are made, the airplane performance application provides runway specific performance information equivalent to AFM-DPI data or airline airport analysis. During approach preparation, the system can provide advisory landing distance information.

Video Surveillance

The video surveillance display may be used at the discretion of the crew to identify individuals requesting flight deck entry or for other airline-specific purposes such as passenger cabin or cargo compartment observation.

Electronic Logbook and Other Documents

The electronic logbook and other electronic documents should be used as defined by operator policy and procedures.

Flight Path Vector (FPV)

The FPV displays Flight Path Angle (FPA) relative to the horizon line and drift angle relative to the center of the pitch scale on the attitude display. This indication uses inertial and barometric altitude inputs. The vertical flight path angle displayed by the FPV should be considered unreliable with unreliable primary altitude displays. The FPV can be used by the pilot in several ways:

- as a reference for establishing and maintaining level flight when the F/D is not in use or not available. When maneuvering the airplane, adjust pitch to place the FPV on the horizon. This results in zero vertical velocity
- as a cross-check of the vertical flight path angle when established in a climb, descent, or on a visual final approach segment

Note: When on final approach, the FPV does not indicate airplane glide path relative to the runway. ILS glide slope, VASI/PAPI or other means must be used for a proper glide path indication.

- in climbs or descents, radar tilt can be adjusted to an appropriate elevation based on the displayed FPA. Radar tilt, like the FPV, is referenced to the horizon. Example: Adjusting the radar tilt to the same angle relative to the horizon as the FPV during climb results in the radar beam centered on the existing flight path

- as a qualitative indication of airplane lateral drift direction if the map is not available. The FPV moves left or right of the pitch scale to indicate the relative position of the ground track to the present heading. The amount of drift cannot be determined from this display unless the airplane is equipped with heading marks on the horizon line. Example: FPV displaced to the left indicates wind component from the right and corresponding drift to the left
- as a reference by the pilot in maintaining proper pitch control with unreliable airspeed indications. Adjust pitch to establish desired flight path by placing the FPV just above, below or on the horizon line.

Note: The FPV should not be used in reference to the PLI, which is a pitch attitude referenced display.

Cold Temperature Altitude Corrections

If the outside air temperature (OAT) is different from standard atmospheric temperature (ISA), barometric altimeter errors result due to non-standard air density. Larger temperature differences from standard result in larger altimeter errors. When the temperature is warmer than ISA, true altitude is higher than indicated altitude. When the temperature is colder than ISA, true altitude is lower than indicated altitude. Extremely low temperatures create significant altimeter errors and greater potential for reduced terrain clearance. These errors increase with higher airplane altitudes above the altimeter source.

Generally, operators should consider altitude corrections when altimeter errors become appreciable, especially where high terrain and/or obstacles exist near airports in combination with very cold temperatures (-30°C/ -22°F or colder). Further, operators should also consider correcting en route minimum altitudes and/or flight levels where terrain clearance is a factor. In some cases corrections may be appropriate for temperatures between 0°C and -30°C.

Operators should coordinate with local and en route air traffic control facilities for each cold weather airport or route in their system. Coordination should include:

- confirmation that minimum assigned altitudes or flight levels provide adequate terrain clearance for the coldest expected temperatures
- cold weather altitude correction procedures to be used for published procedures, to include the table being used
- a determination of which procedures or routes, if any, that have been designed for cold temperatures and can be flown as published (without altitude corrections).

Pilots should note that for very cold temperatures, when flying published minimum altitudes significantly above the airport, altimeter errors can exceed 1000 feet, resulting in potentially unsafe terrain clearance if no corrections are made.

Operation in Icing Conditions

Boeing airplanes are certified to all applicable airworthiness regulations regarding flight in icing conditions. Operators are required to observe all operational procedures concerning flight in these conditions.

Although the process of certifying jet transport airplanes for operation in icing conditions involves many conservative practices, these practices have never been intended to validate operations of unlimited duration in severe icing conditions. The safest course of action is to avoid prolonged operation in moderate to severe icing conditions.

Training Flights

Multiple approaches and/or touch and go landings in icing conditions may result in significant ice accumulations beyond those experienced during typical revenue flights. This may result in fan blade damage as a result of ice accumulation on unheated surfaces shedding into the engines.

Recommended Rudder Trim Technique

This section describes two techniques for properly trimming the rudder. It is assumed that the airplane is properly rigged and in normal cruise. The primary technique uses rudder trim only to level the control wheel and is an acceptable and effective method for trimming the airplane. It is approximately equal to a minimum drag condition. This technique is usable for normal as well as many non-normal conditions. For some non-normal conditions, such as engine failure, this technique is the preferred method and provides near minimum drag.

The alternate technique may provide a more accurate trim condition when the roll is caused by a roll imbalance. In addition, this technique outlines the steps to be taken if the primary trim technique results in an unacceptable bank angle or excessive rudder trim. The alternate technique uses both rudder and aileron trim to neutralize a rolling condition using the bank pointer as reference.

Note: Large trim requirements should be documented for maintenance. Refer to the maintenance manual for guidance.

Drag Factors Due to Trim Technique

If the control wheel is displaced to the point of spoiler deflection a significant increase in aerodynamic drag results. Additionally, any rigging deviation that results in early spoiler actuation causes a significant increase in drag per unit of trim. These conditions result in increased fuel consumption. Small out of trim conditions affect fuel flow by less than 1%, if no spoilers are deflected.

Note: Aileron trim may be required for significant fuel imbalance, airplane damage, or flight control system malfunctions.

Primary Rudder Trim Technique

It is recommended that the autopilot remain engaged while accomplishing the primary rudder trim technique (using rudder trim only). After completing this technique, if the autopilot is disconnected, the airplane should maintain a constant heading.

The following steps define the primary rudder trim technique:

- set symmetrical thrust
- balance fuel if required

737 NG Flight Crew Training Manual

- ensure the autopilot is engaged in HDG SEL and stabilized for at least 30 seconds
- trim the rudder in the direction corresponding to the down (low) side of the control wheel until the control wheel indicates level. The indices on top of the control wheel should be used to ensure a level wheel condition. The airplane is properly trimmed when the control wheel is level, (zero index). As speed, gross weight, or altitude change, trim requirements may also change. In a proper trim condition, there may be a slight forward slip (slight bank angle indicated on the bank pointer) and a slight deflection of the slip/skid indicator, which is acceptable.

Alternate Rudder Trim Technique

The alternate rudder trim technique is used if the primary trim technique results in an unacceptable bank angle, excessive rudder trim, or if a more accurate dual axis trim is required.

The following steps define the alternate rudder trim technique:

- set symmetrical thrust
- balance fuel if required
- verify rudder trim is zero
- ensure the autopilot is engaged in HDG SEL and stabilized for at least 30 seconds
- trim the rudder in the direction corresponding to the down (low) side of the control wheel until the bank indicates level (no bank angle indicated on the bank pointer). Apply rudder trim incrementally, allowing the bank to stabilize after each trim input. Large trim inputs are more difficult to coordinate. The airplane is properly trimmed when the bank angle on the bank pointer indicates zero. If the airplane is properly rigged, the control wheel should indicate approximately level. The resultant control wheel condition indicates the true aileron (roll) trim of the airplane being used by the autopilot.

After completing the alternate rudder trim technique, if the autopilot is disengaged the airplane may have a rolling tendency. Hold the wings level using the sky pointer as reference. Trim out any control wheel forces using the aileron trim switches. If properly trimmed, the airplane holds a constant heading and the aileron trim reading on the wheel/column agrees with what was seen while the autopilot was engaged. Aileron trim inputs require additional time and should be accomplished prior to final approach.

Flight Management Computer(s)/CDUs

The Flight Management System provides the crew with navigation and performance information that can result in a significant crew workload reduction. This workload reduction is fully realized when the system is operated as intended, including proper preflight and timely changes in flight. FMC guidance must always be monitored after any in flight changes. If flight plan changes occur during periods of high workload or in areas of high traffic density, the crew should not hesitate to revert to modes other than LNAV/VNAV.

During preflight, all flight plan or performance related FMC CDU entries made by one pilot must be verified by the other pilot. In flight FMC CDU changes should be made by the PM and executed only after confirmation by the PF.

FMC Route Verification Techniques

After entering the route into the FMC, the crew should verify that the entered route is correct. There are several techniques that may be used to accomplish this. The crew should always compare:

- the filed flight plan with the airways and waypoints entered on the ROUTE pages
- the computer flight plan total distance and estimated fuel remaining with the FMC-calculated distance to destination and the calculated fuel remaining at destination on the PROGRESS page.

For longer flights and flights that are planned to transit oceanic airspace, the crew should cross-check each leg on the LEGS page with the computer flight plan to ensure that the waypoints, magnetic or true tracks, and distances between waypoints match.

If there is a discrepancy noted in any of the above, correct the LEGS page to match the filed flight plan legs. A cross check of the map display using the plan mode may also assist in verification of the flight plan.

FMC Performance Predictions - Non-Normal Configuration

FMC performance predictions are based on the airplane being in a normal configuration. These predictions include:

- climb and descent path predictions including top of climb and top of descent
- ECON, LRC, holding, and engine out speeds
- altitude capability
- step climb points
- fuel remaining at waypoints and destination or alternate
- estimated time of arrival at waypoints and destination or alternate
- holding time available.

737 NG Flight Crew Training Manual

If operating in a non-normal configuration, such as gear down, flaps extended, spoilers extended, gear doors open, etc., these performance predictions are inaccurate. FMC predictions for the climb and descent path are not usable.

Do not use FMC fuel predictions. Cruise fuel predictions are based on a clean configuration. Fuel consumption may be significantly higher than predicted in other configurations.

Note: VNAV PTH operation for approaches is usable for non-normal configurations.

An accurate estimated time of arrival is available if current speed or Mach is entered into the VNAV cruise page. Estimates of fuel remaining at waypoints or the destination may be computed by the crew based upon current fuel flow indications, but should be updated frequently. Performance information for gear down altitude capability and gear down cruise performance is available in the PI chapter of the QRH.

Holding time available is accurate only in the clean configuration provided the FMC holding speed is maintained.

RNP and RNAV Operations

This section describes the basic concepts of RNP and provides information on RNAV operations by phase of flight to include terminal (SIDs and STARs), en-route, and approach.

Basic RNP Concept

RNP has been developed through international cooperation as a means of identifying the navigation performance required for a specified area, route, airspace, procedure or operation. RNP supports use of RNAV systems that use multi-sensor position updating methods such as the flight management computer (FMC). This accuracy is specified in NM (e.g., RNP 0.3 means the performance required is “within 0.3 NM”). RNP values are usually smaller for terminal area procedures (SIDs, STARs, approach transitions, and approaches) than en-route procedures. Small RNP values normally require navigation performance that is more precise than current VOR/ADF navigation, allowing lower weather minima for departures and/or approaches.

The FMC uses one of the following as the displayed RNP:

- default RNP - FMC default values are set by the FMC and are displayed if no RNP is available from the navigation data base or one has not been manually entered
- navigation Data Base RNP - RNP values (if available) are displayed based on values associated with the procedure. These values may be unique for certain segments or terminal procedures
- manually entered RNP - remains until changed or deleted.

The crew may need to make a manual RNP entry if the displayed RNP for the route or procedure is incorrect. Setting an RNP smaller than what is specified for the procedure, airspace, or route, may cause nuisance crew alerts. If the RNP is larger than required for a procedure or segment, inadequate alerting results if needed. Operators should select FMC default values that meet the requirements of their route structure or terminal area procedures. However, AFM requirements may specify RNPs for certain approaches. (For example, RNP 0.3 is required for RNAV (GPS) approaches).

The FMC calculates and displays its Actual Navigation Performance (ANP) as described in the FCOM. When the ANP exceeds the RNP a crew alert is provided. When this occurs on a route or terminal area procedure where an RNP is published, the crew should verify position, confirm updating is enabled, and consider requesting an alternate clearance. This may mean changing to a non-RNP procedure or route or changing to a procedure or route with a RNP higher than the displayed ANP value. Crews should note that ANP is only related to the accuracy of FMC position. Lateral deviation from the route or procedural track is indicated by the XTK ERROR (cross-track error) value shown by the FMC. LNAV should be used with the autopilot engaged to minimize cross-track error. Excessive XTK ERROR does not result in a crew alert.

Note: The NPS system (as installed) provides an alert on the PFD when lateral or vertical deviation exceeds preset limits. Reference the FCOM for specific NPS system indications and description.

The following illustration shows the FMC position and displayed ANP and shows the relationship of ANP to RNP for a particular route segment. Normally, a route segment or procedural leg is defined by its required width (the illustration shows 2.0 NM either side of the centerline). RNP is normally set at 50% of the allowed maximum deviation from the route centerline. Required width is determined by minimum terrain or traffic clearance requirements. The probability of exceeding this maximum deviation while in LNAV with the autopilot engaged is very small. For each airplane type, minimum demonstrated RNPs are given in the AFM. These minimum values vary depending on LNAV, flight director and autopilot use.

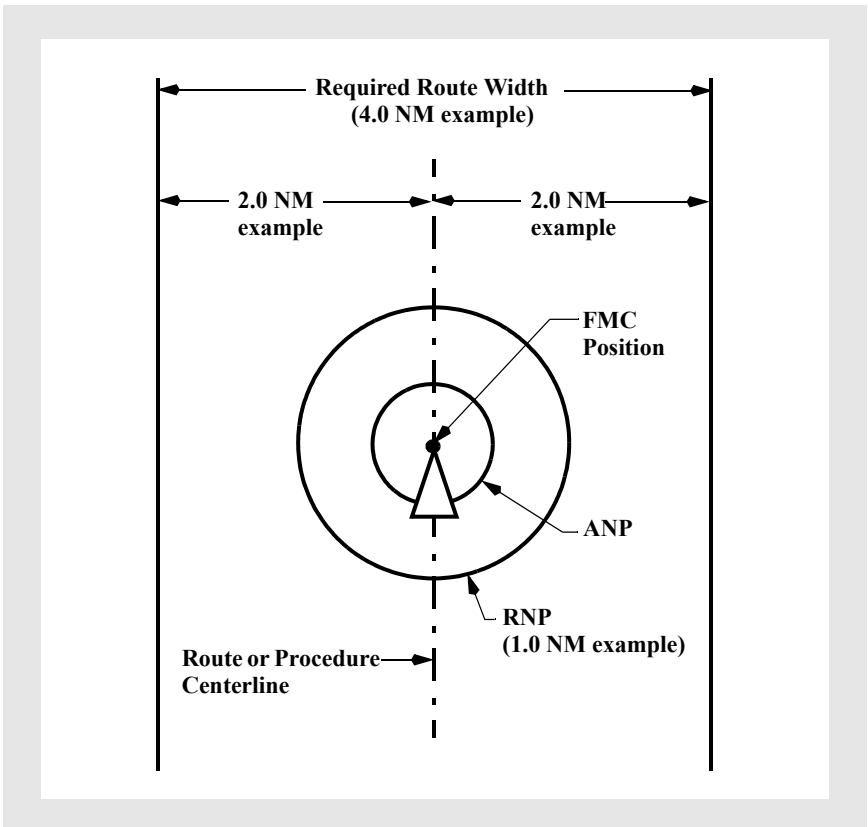
RNAV Route and RNP/ANP

RNAV Operations: En-route, Terminal, and Approach

All Boeing FMCs are capable of performing RNAV operations. Regarding navigation accuracy, these FMCs differ only by demonstrated RNP capabilities and the ability to use GPS updating.

En-route operations can be defined as oceanic and domestic. Oceanic RNAV requirements are described in detail in the applicable MNPS guidance material such as the Pacific or North Atlantic manuals. Specific routes or areas of operation are given RNP values based on route separation requirements. RNP 10 routes are suitable for all FMCs that are capable of GPS updating and those FMCs that cannot update from GPS but have received the last radio update within the previous six hours.

In general, oceanic operations require dual navigation systems (dual FMC or single FMC in combination with alternate navigation capability).

Domestic en-route RNAV operations depend on the availability of radio updating (DME-DME) sources to support domestic RNP. The following domestic RNP operations are fully supported by any Boeing FMC with DME-DME or GPS updating active:

- USA and Canada - RNP 2.0 or higher
- Europe - B-RNAV (RNP 5.0)
- Asia - As specified for the route or area (e.g. RNP 4 or RNP 10 routes)
- Africa - As specified for the route or area

Terminal RNAV operations (SIDs, STARS and Transitions) are fully compatible with all FMCs with DME-DME or GPS updating active and are defined as:

- USA and Canada - RNP 1.0 SIDs and STARS
- Europe - P-RNAV (RNP 1.0)

RNAV approaches are compatible with all FMCs provided DME-DME or GPS updating is active at the beginning of the approach and the approach RNP is equal to or greater than the minimum demonstrated RNP in the AFM. Restrictions published on some RNAV approaches may preclude their use without GPS updating active.

For published RNAV approaches, all Boeing FMCs have RNP 0.5 capability with DME-DME updating active without GPS updating. See the Approach section of this manual for further details regarding the techniques for flying RNAV approaches.

GPS Use in Non-WGS-84 Reference Datum Airspace

In non-WGS-84 airspace, the local datum (position basis) used to survey the navigation data base position information may result in significant position errors from a survey done using the WGS-84 datum. To the pilot, this means that the position of runways, airports, waypoints, nav aids, etc., may not be as accurate as depicted on the map display and may not agree with the GPS position. Operators should consult appropriate sources to determine the current status of airspace in which they operate.

A worldwide survey has been conducted which determined that using the FMC while receiving GPS position updating during SIDS, STARS and enroute navigation meets the required navigation accuracy in non-WGS-84 airspace. This navigation position accuracy may not be adequate for approaches, therefore the AFM requires the crew to inhibit GPS position updating while flying approaches in non-WGS-84 airspace “unless other appropriate procedures are used.”

737 NG Flight Crew Training Manual

Boeing's recommendations for operators are as follows:

- Provided operational approval has been received and measures to ensure their accuracy have been taken, RNAV approaches may be flown with GPS updating enabled. Options available to operators may include surveys of the published approaches to determine if significant differences or position errors exist, developing special RNAV procedures complying with WGS-84 or equivalent, or inhibiting GPS updating
- For approaches based upon ground-based navigation aids such as ILS, VOR, LOC, NDB, etc., the GPS updating need not be inhibited provided that appropriate raw data is used throughout the approach and missed approach as the primary navigation reference. LNAV and VNAV may be used. As always, when a significant difference exists between the airplane position, raw data course, DME and/or bearing information, discontinue use of LNAV and VNAV. Provided the FMC is not used as the primary means of navigation for approaches, this method can be used as the “other appropriate procedure” in lieu of inhibiting GPS updating.

Operators are encouraged to survey their navigation data bases and have all non-WGS-84 procedures eliminated or modified to WGS-84 standards.

Weather Radar and Terrain Display Policy

Whenever the possibility exists for adverse weather and terrain/obstacles near the intended flight path, one pilot should monitor the weather radar display and the other pilot should monitor the terrain display. The use of the terrain display during night or IMC operations, on departure and approach when in proximity to terrain/obstacles, and at all times in non-radar environments is recommended.

Note: It may be useful to show the terrain display at other times to enhance terrain/situational awareness.

AFDS Guidelines

Crewmembers must coordinate their actions so that the airplane is operated safely and efficiently.

Autopilot engagement should only be attempted when the airplane is in trim, F/D commands (if the F/D is on) are essentially satisfied and the airplane flight path is under control. The autopilot is not certified or designed to correct a significant out of trim condition or to recover the airplane from an abnormal flight condition and/or unusual attitude.

Autothrottle Use

Autothrottle use is recommended during takeoff and climb in either automatic or manual flight. During all other phases of flight, autothrottle use is recommended only when the autopilot is engaged.

Autothrottle ARM Mode

The autothrottle ARM mode is normally not recommended because its function can be confusing. The primary feature the autothrottle ARM mode provides is minimum speed protection in the event the airplane slows to minimum maneuvering speed. Other features normally associated with the autothrottle, such as gust protection, are not provided. The autothrottle ARM mode should not be used with Non-Normal Checklists. Some malfunctions that affect maneuvering speeds cause the autothrottle to maintain a speed above approach speed.

Manual Flight

The PM should make AFDS mode selections at the request of the PF. Heading and altitude changes from ATC clearances and speed selections associated with flap position changes may be made without specific directions. However, these selections should be announced, such as, "HEADING 170 SET". The PF must be aware such changes are being made. This enhances overall safety by requiring that both pilots are aware of all selections, while still allowing one pilot to concentrate on flight path control.

Ensure the proper flight director modes are selected for the desired maneuver. If the flight director commands are not to be followed, the flight director should be turned off.

Automatic Flight

Autoflight systems can enhance operational capability, improve safety, and reduce workload. Automatic approach and landing, Category III operations, and fuel-efficient flight profiles are examples of some of the enhanced operational capabilities provided by autoflight systems. Maximum and minimum speed protection are among the features that can improve safety while LNAV, VNAV, and instrument approaches using VNAV are some of the reduced workload features. Varied levels of automation are available. The pilot decides what level of automation to use to achieve these goals by selecting the level that provides the best increase in safety and reduced workload.

Note: When the autopilot is in use, the PF makes AFDS mode selections. The PM may select new altitudes, but must ensure the PF is aware of any changes. Both pilots must monitor AFDS mode annunciations and the current FMC flight plan.

737 NG Flight Crew Training Manual

Automatic systems give excellent results in the vast majority of situations. Deviations from expected performance are normally due to an incomplete understanding of their operations by the flight crew. When the automatic systems do not perform as expected, the pilot should reduce the level of automation until proper control of path and performance is achieved. For example, if the pilot failed to select the exit holding feature when cleared for the approach, the airplane will turn outbound in the holding pattern instead of initiating the approach. At this point, the pilot may select **HEADING SELECT** and continue the approach while using other automated features. A second example, if the airplane levels off unexpectedly during climb or descent with **VNAV** engaged, **LVL CHG** may be selected to continue the climb or descent until the **FMC** can be programmed.

Early intervention prevents unsatisfactory airplane performance or a degraded flight path. Reducing the level of automation as far as manual flight may be necessary to ensure proper control of the airplane is maintained. The pilot should attempt to restore higher levels of automation only after airplane control is assured. For example, if an immediate level-off in climb or descent is required, it may not be possible to comply quickly enough using the **AFDS**. The **PF** should disconnect the autopilot and level off the airplane manually at the desired altitude. After level off, set the desired altitude in the **MCP**, select an appropriate pitch mode and re-engage the autopilot.

Recommended Pitch and Roll Modes

If the **LEGS** page and map display reflect the proper sequence and altitudes, **LNAV** and **VNAV** are recommended. If **LNAV** is not used, use an appropriate roll mode. When **VNAV** is not used, the following modes are recommended:

LVL CHG is the preferred mode for altitude changes of 1,000 feet or more. **V/S** is preferred if the altitude change is less than 1,000 feet.

If unplanned speed or altitude restrictions are imposed during the arrival, the continued use of **VNAV** may induce an excessive workload. If this occurs, use **LVL CHG** or **V/S** as appropriate.

Pilot Incapacitation

Pilot incapacitation occurs frequently compared with other routinely trained non-normal conditions. It has occurred in all age groups and during all phases of flight. Incapacitation occurs in many forms ranging from sudden death to subtle, partial loss of mental or physical performance. Subtle incapacitations are the most dangerous and they occur the most frequently. Incapacitation effects can range from loss of function to unconsciousness or death.

The key to early recognition of pilot incapacitation is the regular use of crew resource management concepts during flight deck operation. Proper crew coordination involves checks and crosschecks using verbal communications. Routine adherence to standard operating procedures and standard profiles can aid in detecting a problem. Suspicion of some degree of gross or subtle incapacitation should also be considered when a crewmember does not respond to any verbal communication associated with a significant deviation from a standard procedure or standard flight profile. Failure of any crewmember to respond to a second request or a checklist response is cause for investigation.

If you do not feel well, let the other pilot know and let that pilot fly the airplane. During flight, crewmembers should also be alert for incapacitation of the other crewmember.

Crew Action Upon Confirming Pilot Incapacitation

If a pilot is confirmed to be incapacitated, the other pilot shall take over the controls and check the position of essential controls and switches.

- after ensuring the airplane is under control, engage the autopilot to reduce workload
- declare an emergency
- use the cabin crew (if available). When practical, try to restrain the incapacitated pilot and slide the seat to the full-aft position. The shoulder harness lock may be used to restrain the incapacitated pilot
- flight deck duties should be organized to prepare for landing
- consider using help from other pilots or crewmembers aboard the airplane.

Turbulent Air Penetration

Severe turbulence should be avoided if at all possible. However, if severe turbulence is encountered, use the Severe Turbulence procedure listed in the Supplementary Procedures section of the FCOM. Turbulent air penetration speeds provide high/low speed margins in severe turbulent air.

During manual flight, maintain wings level and smoothly control attitude. Use the attitude indicator as the primary instrument. In extreme updrafts or downdrafts, large altitude changes may occur. Do not use sudden or large control inputs. After establishing the trim setting for penetration speed, do not change pitch trim. Allow altitude and airspeed to vary and maintain attitude. However, do not allow the airspeed to decrease and remain below the turbulent air penetration speed because stall/buffet margin is reduced. Maneuver at bank angles below those normally used. Set thrust for penetration speed and avoid large thrust changes. Flap extension in an area of known turbulence should be delayed as long as possible because the airplane can withstand higher gust loads with the flaps up.

**737 NG Flight Crew Training Manual**

Normally, no changes to cruise altitude or airspeed are required when encountering moderate turbulence. If operating at cruise thrust limits, it may be difficult to maintain cruise speed. If this occurs, select a higher thrust limit (if available) or descend to a lower altitude.



Intentionally
Blank



Ground Operations

Chapter 2

Table of Contents

Section TOC

Preface 2.1

Takeoff Briefing 2.1

Push Back 2.2

 Backing with Reverse Thrust 2.2

Taxi 2.2

 Taxi General 2.2

 Flight Deck Perspective 2.4

 Thrust Use 2.4

 Taxi Speed and Braking 2.4

 Antiskid Inoperative 2.5

 Nose Wheel/Rudder Pedal Steering 2.5

 Turning Radius and Gear Tracking 2.6

 Visual Cues and Techniques for Turning while Taxiing 2.7

 Turns of 180 Degrees 2.7

 Taxi - Adverse Weather 2.11

 Taxi - One Engine 2.13



Intentionally
Blank



Preface

This chapter outlines the recommended operating practices and techniques during ground operations, including pushback, engine start and taxi. Taxi operations during adverse weather are also addressed. The recommended operating practices and techniques discussed in this chapter improve crew coordination, enhance safety and provide a basis for standardization.

Takeoff Briefing

The takeoff briefing should be accomplished as soon as practical so it does not interfere with the final takeoff preparations.

The takeoff briefing is a description of the departure flight path with emphasis on anticipated track and altitude restrictions. It assumes normal operating procedures are used. Therefore, it is not necessary to brief normal or standard takeoff procedures. Additional briefing items may be required when any elements of the takeoff and/or departure are different from those routinely used. These may include:

- adverse weather
- adverse runway conditions
- unique noise abatement requirements
- dispatch using the minimum equipment list
- special engine out departure procedures (if applicable)
- any other situation where it is necessary to review or define crew responsibilities.

Push Back

Each operator should develop specific pushback procedures and policies which are tailored for their specific operations. The flight operations and maintenance departments need to be primary in developing these procedures.

Pushbacks present a serious hazard to ground personnel. There have been many accidents where personnel were run over by the airplane wheels during the pushback process.

Pushback or towing involves three phases:

- positioning and connecting the tug and tow bar
- moving the airplane
- disconnecting the tow bar.

Proper training of both pilots and ground maintenance and good communication between the flight deck and ground personnel are essential for a safe pushback operation.

The headset operator, who is walking in the vicinity of the nose wheels, is usually the person injured or killed in the majority of the accidents. Procedures that do not have personnel in the vicinity of the nose wheels help to reduce the possibility of these type accidents.

Note: Pushback or tow out is normally accomplished with all hydraulic systems pressurized and the nose wheel steering locked out.

The captain should ensure that all appropriate checklists are completed prior to airplane movement. All passengers should be in their seats, all doors closed and all equipment away from the airplane. After the tow tractor and tow bar have been connected, obtain a pushback clearance from ground control. Engine start may be accomplished during the pushback or delayed until the pushback is completed. Ground personnel should be on headset to observe and communicate any possible safety hazards to the flight crew.

Note: The airplane should not be taxied away from a gate, or pushback position, unless the marshaller clears the airplane to taxi.

Backing with Reverse Thrust

Backing with reverse thrust is not recommended.

Taxi

Taxi General

An airport diagram should be kept in a location readily available to both crewmembers during taxi. The following guidelines aid in conducting safe and efficient taxi operations:

737 NG Flight Crew Training Manual

Prior to Taxi

- both pilots verify the correct airplane parking position is entered into the FMC
- brief applicable items from airport diagrams and related charts
- ensure both crewmembers understand the expected taxi route
- write down the taxi clearance when received.

During Taxi

- progressively follow taxi position on the airport diagram
- during low visibility conditions, call out all signs to verify position
- if unfamiliar with the airport consider requesting a FOLLOW ME vehicle or progressive taxi instructions
- use standard radio phraseology
- read back all clearances. If any crewmember is in doubt regarding the clearance, verify taxi routing with the written clearance or with ATC. Stop the airplane if the clearance is in doubt
- when ground/obstruction clearance is in doubt, stop the airplane and obtain a wing-walker
- avoid distractions during critical taxi phases; plan ahead for checklist accomplishment and company communications
- consider delaying checklist accomplishment until stopped during low visibility operations
- do not allow ATC or anyone else to rush you
- verify the runway is clear (both directions) and clearance is received prior to entering a runway
- be constantly aware of the equipment, structures, and airplanes behind you when the engines are above idle thrust
- consider using the taxi light to visually indicate movement
- at night use all appropriate airplane lighting
- when entering any active runway ensure the exterior lights specified in the FCOM are illuminated.

Prior to Landing

- plan/brief the expected taxiway exit and route to parking.

After Landing

- ensure taxi instructions are clearly understood, especially when crossing closely spaced parallel runways
- delay company communications until clear of all runways.

Flight Deck Perspective

There is a large area near the airplane where personnel, obstacles or guidelines on the ground cannot be seen, particularly in the oblique view across the flight deck. Special care must be exercised in the parking area and while taxiing. When parked, the pilot should rely on ground crew communications to a greater extent to ensure a safe, coordinated operation.

The pilot's seat should be adjusted for optimum eye position. The rudder pedals should be adjusted so that it is possible to apply maximum braking with full rudder deflection.

During taxiing, the pilot's heels should be on the floor, sliding the feet up on the rudder pedals only when required to apply brakes to slow the taxi speed, or when maneuvering in close quarters on the parking ramp.

Thrust Use

Thrust use during ground operation demands sound judgment and technique. Even at relatively low thrust the air blast effects from the large, high bypass engines can be destructive and cause injury. Airplane response to thrust lever movement is slow, particularly at high gross weights. Engine noise level in the flight deck is low and not indicative of thrust output. Idle thrust is adequate for taxiing under most conditions. A slightly higher thrust setting is required to begin taxiing. Allow time for airplane response before increasing thrust further.

Excess thrust while taxiing may cause foreign objects to deflect into the lower aft fuselage, stabilizer, or elevators, especially when the engines are over an unimproved surface. Run-ups and taxi operations should only be conducted over well maintained paved surfaces and runways.

Taxi Speed and Braking

To begin taxi, release brakes, smoothly increase thrust to minimum required for the airplane to roll forward, and then reduce thrust as required to maintain normal taxi speed. A turn should normally not be started until sufficient forward speed has been attained to carry the airplane through the turn at idle thrust.

The airplane may appear to be moving slower than it actually is due to the flight deck height above the ground. Consequently, the tendency may be to taxi faster than desired. This is especially true during runway turnoff after landing. The ground speed display on the flight instruments may be used to determine actual taxi speed. The appropriate taxi speed depends on turn radius and surface condition.

Note: Some taxi speeds, usually between 10 and 20 knots, can cause an increase in airplane vibration, especially on rough taxiways. If this occurs, a slight increase or decrease in speed reduces or eliminates the vibration and increases passenger comfort.

737 NG Flight Crew Training Manual

Taxi speed should be closely monitored during taxi out, particularly when the active runway is some distance from the departure gate. Normal taxi speed is approximately 20 knots, adjusted for conditions. On long straight taxi routes, speeds up to 30 knots are acceptable, however at speeds greater than 20 knots use caution when using the nose wheel steering wheel to avoid overcontrolling the nose wheels. When approaching a turn, speed should be slowed to an appropriate speed for conditions. On a dry surface, use approximately 10 knots for turn angles greater than those typically required for high speed runway turnoffs.

Note: High taxi speed combined with heavy gross weight and a long taxi distance can result in tire sidewall overheating.

Avoid prolonged brake application to control taxi speed as this causes high brake temperatures and increased wear of brakes. If taxi speed is too high, reduce speed with a steady brake application and then release the brakes to allow them to cool. Braking to approximately 10 knots and subsequent release of the brakes results in less heat build-up in the tires and brakes than when the brakes are constantly applied.

Under normal conditions, differential braking and braking while turning should be avoided. Allow for decreased braking effectiveness on slippery surfaces.

Avoid following other airplanes too closely. Jet blast is a major cause of foreign object damage.

During taxi, the use of reverse thrust above reverse idle is not recommended due to the possibility of foreign object damage and engine surge. Momentary use of idle reverse thrust may be necessary on slippery surfaces for airplane control while taxiing. Consider having the airplane towed rather than relying on extended use of reverse thrust for airplane control.

Antiskid Inoperative

With antiskid inoperative, tire damage or blowouts can occur if moderate to heavy braking is used. With this condition, it is recommended that taxi speed be adjusted to allow for very light braking.

Nose Wheel/Rudder Pedal Steering

The captain's and first officer's (if installed) positions are equipped with a nose wheel steering wheel. The nose wheel steering wheel is used to turn the nose wheel through the full range of travel at low taxi speeds. Maintain positive pressure on the nose wheel steering wheel at all times during a turn to prevent the nose wheels from abruptly returning to center. Rudder pedal steering turns the nose wheels through a limited range of travel. Straight ahead steering and large radius turns may be accomplished with rudder pedal steering.

If nose wheel “scrubbing” occurs while turning, reduce steering angle and/or taxi speed. Avoid stopping the airplane in a turn as excessive thrust is required to start taxiing again.

Differential thrust may be required at high weights during tight turns. This should only be used as required to maintain the desired speed in the turn. After completing a turn, center the nose wheels and allow the airplane to roll straight ahead. This relieves stresses in the main and nose gear structure prior to stopping.

Turning Radius and Gear Tracking

During all turning maneuvers, crews should be aware of their position relative to the nose and main landing gear. The pilot seat position being forward of the nose wheels and main gear is depicted in the tables in this chapter.

As the following diagram illustrates, while the airplane is turning, the main gear tracks inside the nose gear. The smaller the radius of the turn, the greater the distance that the main gear tracks inside the nose gear and the greater the need to steer the nose gear outside of the taxi path (oversteer).

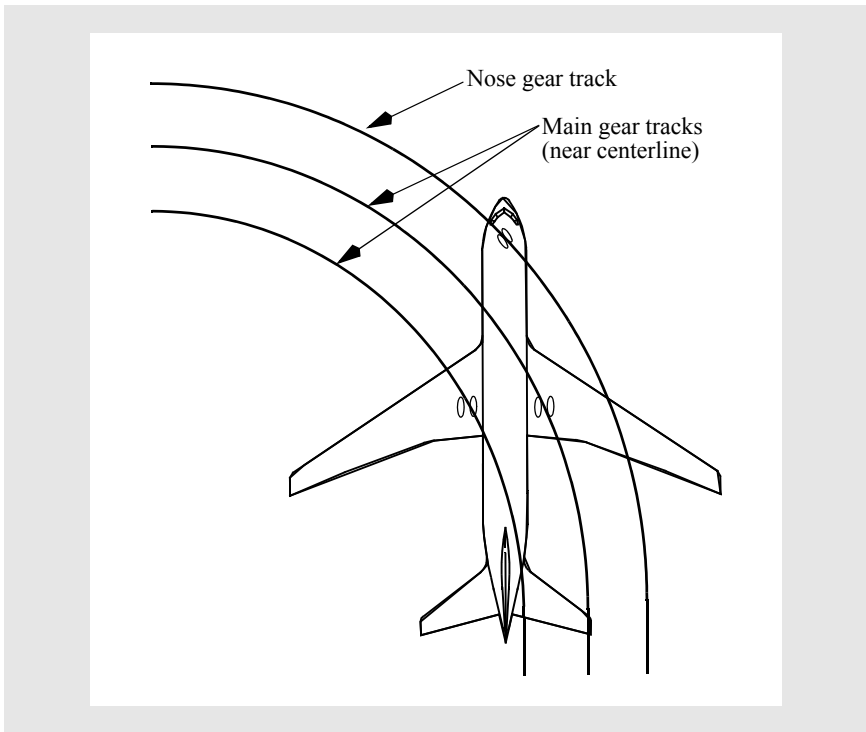

Visual Cues and Techniques for Turning while Taxiing

The following visual cues assume the pilot's seat is adjusted for proper eye position. The following techniques also assume a typical taxiway width. Since there are many combinations of turn angles, taxiway widths, fillet sizes and taxiway surface conditions, pilot judgment must dictate the point of turn initiation and the amount of nose wheel steering wheel required for each turn. Except for turns less than approximately 30°, speed should be 10 knots or less prior to turn entry. For all turns, keep in mind the main gear are located behind the nose wheels, which causes them to track inside the nose wheels during turns. The pilot position being forward of the nose wheels and main gear is depicted in the table below.

Model	Pilot Seat Position (forward of nose gear) feet (meters)	Pilot Seat Position (forward of main gear) feet (meters)
737 - 600	5.25 (1.6)	42 (12.8)
737 - 700	5.25 (1.6)	47 (14.3)
737 - 800	5.25 (1.6)	56 (17.1)
737 - 900	5.25 (1.6)	62 (18.9)

Turns less than 90 degrees

Use a technique similar to other large airplanes: steer the nose wheels far enough beyond the centerline of the turn to keep the main gear close to the centerline.

Turns of 90 degrees or more

Initiate the turn as the intersecting taxiway centerline (or intended exit point) approaches approximately the center of the number 3 window. Initially use approximately full nose wheel steering wheel displacement. Adjust the steering wheel input as the airplane turns to keep the nose wheels outside of the taxiway centerline, near the outside radius of the turn. Nearing turn completion, when the main gear are clear of the inside radius, gradually release the steering wheel input as the airplane lines up with the intersecting taxiway centerline or intended taxi path.

Turns of 180 Degrees

If the available taxi surface is narrow, coordination with ATC and ground support personnel may be required to complete the operation safely. Reference special aerodrome operating instructions, if available. In some cases (e.g., heavy weight, pilot uncertainty of runway and/or taxiway pavement edge locations and related safety margins, nearby construction, vehicles, potential FOD damage, etc.), towing the airplane to the desired location may be the safest option.

If a minimum radius 180° turn is necessary, consider using the ground crew to monitor the wheel path and provide relevant information as the turn progresses. The ground crew should be warned of the risk associated with jet blast and position themselves to avoid the hazard. Also ensure that obstacle clearance requirements are met. Since more than idle thrust is required, the flight crew must be aware of buildings or other objects in the area being swept by jet blast during the turn.

Note: Monitor the nose gear track closely, as it will leave the pavement in the turn before the main gear.

Approach the edge of the taxi surface at a shallow angle until the outboard side of the main gear wheels are near the edge. The main gear are just inside the engine nacelles. Maneuver to keep the engine nacelles over the prepared surfaces.

Note: Painted runway markings are slippery when wet and may cause skidding of the nose gear during the turn.

Turning radius can be reduced by following a few specific taxi techniques. Taxi the airplane so that the main gear tires are close to the runway edge. This provides more runway surface to make the turn. Stop the airplane completely with the thrust at idle. Hold the nose wheel steering wheel to the maximum steering angle, release the brakes, then add thrust on the outboard engine. Only use the engine on the outboard side of the turn and maintain 5 to 10 knots during the turn to minimize turn radius. Light intermittent braking on the inside main gear helps decrease turn radius. Stopping the airplane in a turn is not recommended unless required to reduce the turn radius. As the airplane passes through 90° of turn, steer to place the main gear approximately on the runway centerline, then gradually reduce the nose wheel steering wheel input as required to align the airplane with the new direction of taxi. These actions result in a low speed turn and less runway being used. Wind, slope, runway or taxiway surface conditions, and center of gravity may also affect the turning radius.

The following diagrams show suggested airplane ground tracks for minimum radius 180° turns with various runway turnaround configurations. These ground tracks provide the best maneuver capability while providing the maximum runway length available for takeoff at the completion of the turn. However, this type of maneuvering is normally not required unless operating on runways less than 148 feet (45m) in width.

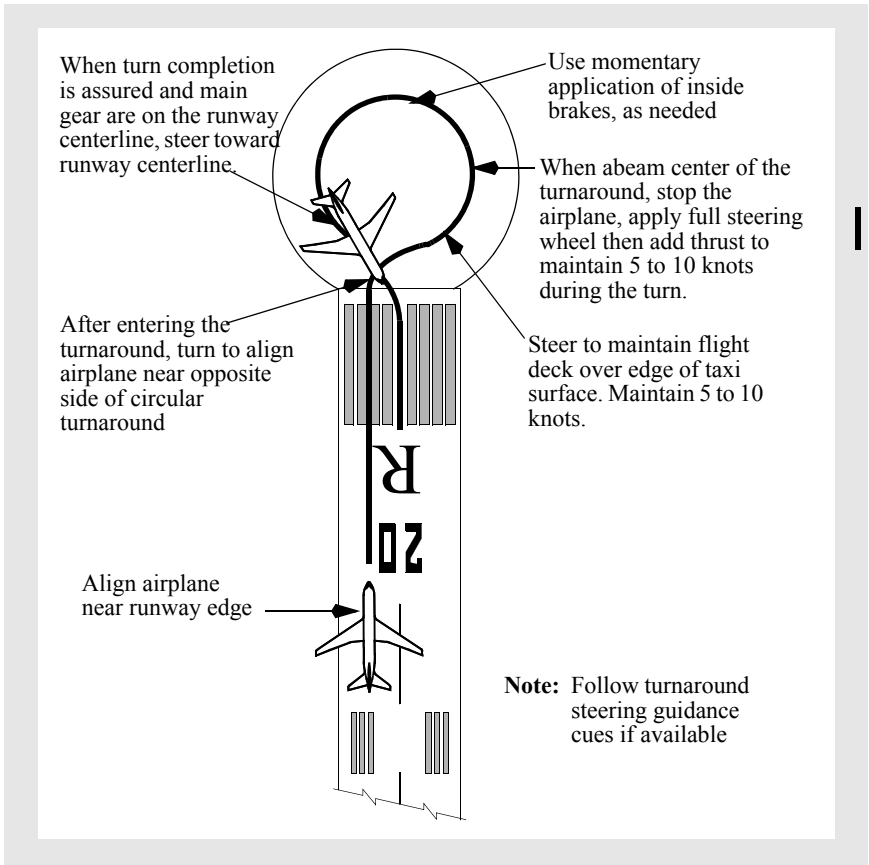
737 NG Flight Crew Training Manual
Techniques when using a Circular Turnaround

Techniques when using a Hammerhead Turnaround

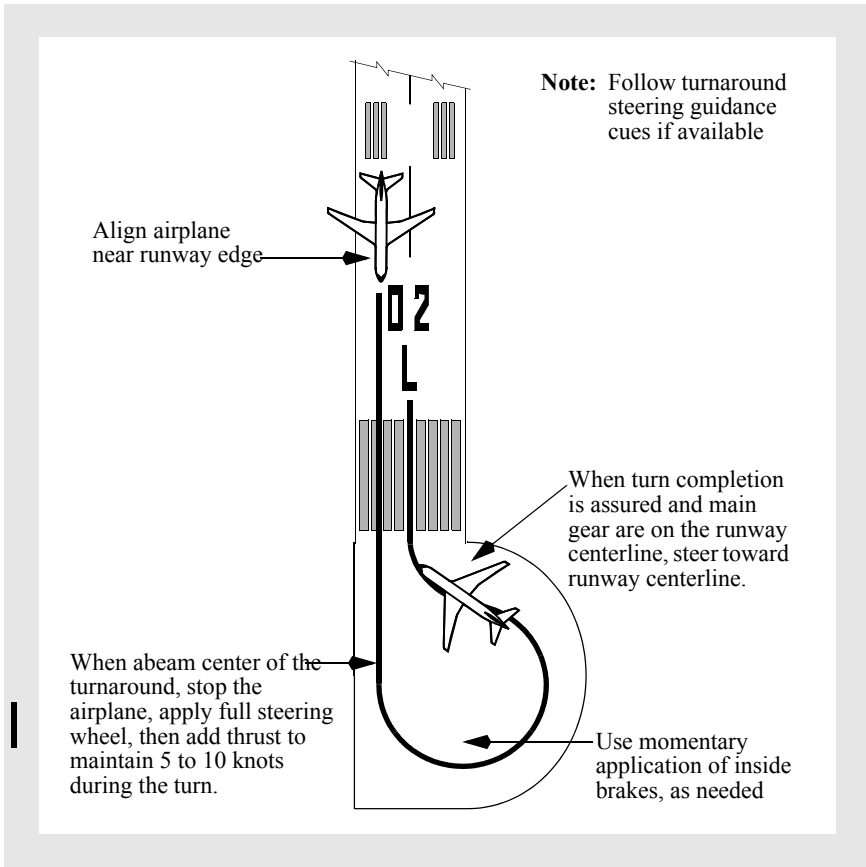

Techniques when using a Hammerhead Turnaround

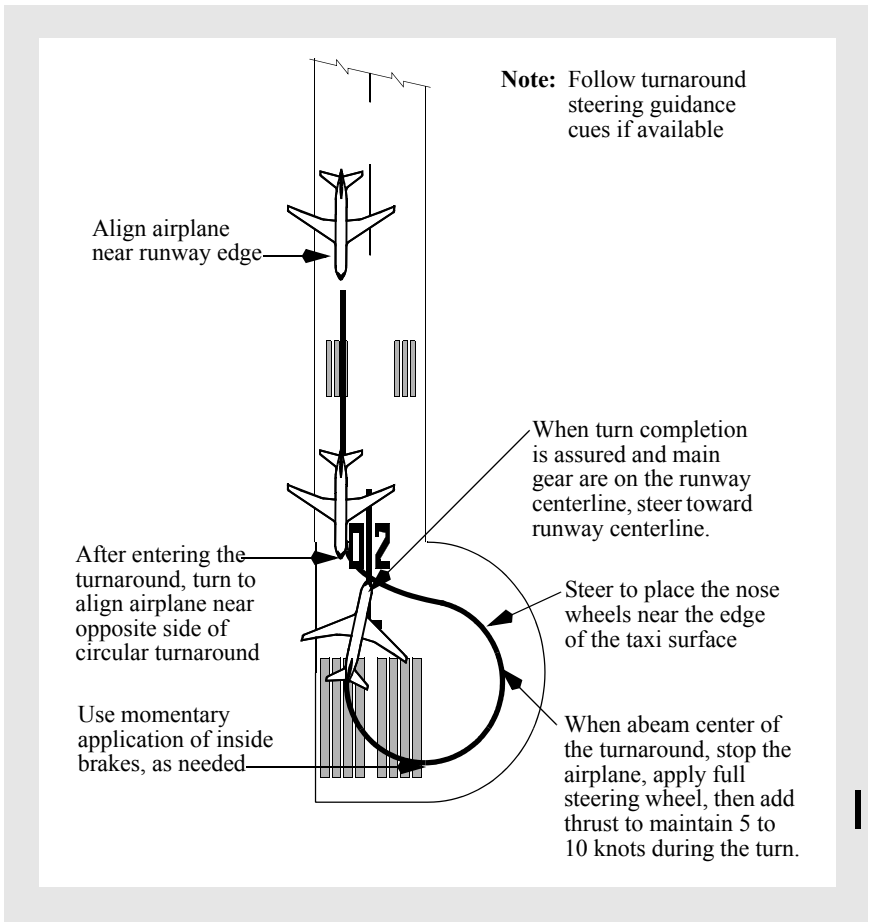

Taxi - Adverse Weather

Taxi under adverse weather conditions requires more awareness of surface conditions.

When taxiing on a slippery or contaminated surface, particularly with strong crosswinds, use reduced speeds. Use of differential engine thrust assists in maintaining airplane momentum through the turn. When nearing turn completion, placing both engines to idle thrust reduces the potential for nose gear skidding. Avoid using large nose wheel steering inputs to correct for skidding. Differential braking may be more effective than nose wheel steering on slippery or contaminated surfaces. If speed is excessive, reduce speed prior to initiating a turn.

Note: A slippery surface is any surface where the braking capability is less than that on a dry surface. Therefore, a surface is considered “slippery” when it is wet or contaminated with ice, standing water, slush, snow or any other deposit that results in reduced braking capability.

During cold weather operations, nose gear steering should be exercised in both directions during taxi. This circulates warm hydraulic fluid through the steering cylinders and minimizes the steering lag caused by low temperatures. If icing conditions are present, use anti-ice as required by the FCOM.

During prolonged ground operations, periodic engine run-ups should be accomplished to minimize ice build-up. These engine run-ups should be performed as defined in the FCOM.

Engine exhaust may form ice on the ramp and takeoff areas of the runway, or blow snow or slush which may freeze on airplane surfaces. If the taxi route is through slush or standing water in low temperatures, or if precipitation is falling with temperatures below freezing, taxi with flaps up. Extended or prolonged taxi times in heavy snow may necessitate de-icing prior to takeoff.

To reduce the possibility of flap damage after making an approach in icing conditions or landing on a runway covered with snow or slush, do not retract the flaps to less than 15 until the flap area has been checked for debris by maintenance.

Low Visibility

Pilots need a working knowledge of airport surface lighting, markings, and signs for low visibility taxi operations. Understanding the functions and procedures to be used with stop bar lights, ILS critical area markings, holding points, and low visibility taxi routes is essential to conducting safe operations. Many airports have special procedures for low visibility operations. For example, airports operating under FAA criteria with takeoff and landing minimums below 1200ft (350m) RVR are required to have a low visibility taxi plan.

Taxi - One Engine

Because of additional operational procedural requirements and crew workload, taxiing out for flight with an engine shut down is not recommended. High bypass engines require warm up prior to applying takeoff thrust and cool down prior to shutting down. If the engine has been shut down for several hours, it is desirable to operate at as low a thrust setting as practical for several minutes prior to takeoff.

If an engine is shutdown during taxi in after flight, the crew must be aware of systems requirements, (hydraulics, brakes, electrical). The APU should be operating while taxiing with an engine shutdown. If possible, make minimum radius turns in a direction that puts the operating engine on the outside of the turn. In operational environments such as uphill slope, soft asphalt, high gross weights, congested ramp areas, and wet/slippery ramps and taxiways, taxi with both engines operating.



Intentionally
Blank



Takeoff and Initial Climb

Chapter 3

Table of Contents

Section TOC

Preface 3.1

Takeoff 3.2

 Takeoff Profile 3.2

 Takeoff - General 3.3

 Thrust Management 3.3

 Initiating Takeoff Roll 3.3

 Rotation and Liftoff - All Engines 3.7

 Effect of Rotation Speed and Pitch Rate on Liftoff 3.10

 Center-Of-Gravity (CG) Effects 3.11

Crosswind Takeoff 3.12

 Takeoff Crosswind Guidelines 3.12

 Directional Control 3.13

 Rotation and Takeoff 3.13

 Gusty Wind and Strong Crosswind Conditions 3.13

Reduced Thrust Takeoff 3.14

 Assumed Temperature Method (ATM) 3.14

 Fixed Derate 3.15

 Combination Fixed Derate and ATM 3.15

Improved Climb Performance Takeoff 3.15

Low Visibility Takeoff 3.16

Adverse Runway Conditions 3.16

 Effect of Deicing/Anti-Icing Fluids on Takeoff 3.17

Federal Aviation Regulation (FAR) Takeoff Field Length 3.17

 FAR Takeoff 3.18



Rejected Takeoff Decision	3.19
Rejected Takeoff Maneuver	3.20
Go/Stop Decision Near V1	3.20
RTO Execution Operational Margins	3.21
Initial Climb - All Engines	3.24
Minimum Fuel Operation - Takeoff	3.24
Immediate Turn after Takeoff - All Engines	3.24
Roll Modes	3.25
Autopilot Engagement	3.25
Flap Retraction Schedule	3.25
Noise Abatement Takeoff	3.26
Takeoff - Engine Failure	3.27
General	3.27
Engine Failure Recognition	3.27
Rotation and Liftoff - One Engine Inoperative	3.27
Initial Climb - One Engine Inoperative	3.31
Immediate Turn after Takeoff - One Engine Inoperative	3.31
Autopilot Engagement - One Engine Inoperative	3.31
Flap Retraction - One Engine Inoperative	3.32
Flaps Up - One Engine Inoperative	3.32
Noise Abatement - One Engine Inoperative	3.32
Engine Failure During an ATM Takeoff	3.32
Engine Failure During a Fixed Derate Takeoff	3.33
Engine Failure During a Combined Takeoff	3.33



Preface

This chapter outlines the recommended operating practices and techniques for takeoff and initial climb. Engine failure during takeoff/initial climb is also addressed. The discussion portion of each illustration highlights important information.

The flight profile illustrations represent the recommended basic configuration during the accomplishment of the flight maneuvers, and provides a basis for standardization and crew coordination.

Takeoff

Takeoff Profile

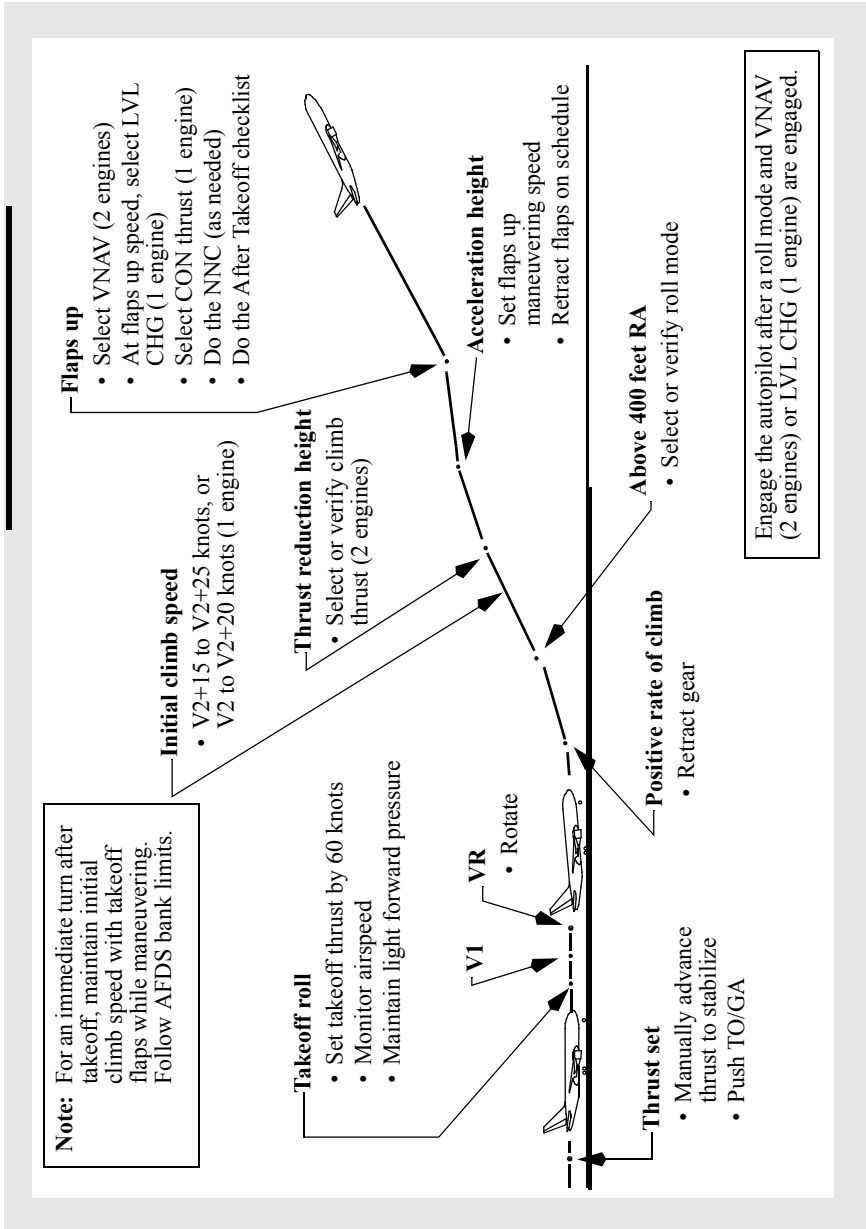

Takeoff - General

Normal takeoff procedures satisfy typical noise abatement requirements. Some airports may have special procedures which require modification of the takeoff profile.

As part of the before start procedure, review the TAKEOFF REF page to ensure the entries are correct and the preflight is complete. Ensure V2 is set on the MCP. The map display, map range and LEGS page sequence should be consistent with the departure procedure.

Review the LEGS page for any climb constraints. Ensure the CLB page contains the appropriate altitude and airspeed restrictions consistent with the departure procedure.

Note: The lower center MFD is normally blank for takeoff to reduce display of unnecessary information.

Although flaps up speed to 3,000 feet is generally recommended for noise abatement reasons, it may not be required except at heavy weights. At lighter weights the performance of the airplane is such that 3,000 feet is usually reached before flap retraction is complete.

The PF should normally display the TAKEOFF REF page. To reduce heads down activity, climb constraint modification immediately after takeoff should normally be accomplished on the mode control panel. Modify the CLB page when workload permits. The PM should display the LEGS page of the FMC for departure to allow timely route modification if necessary.

Thrust Management

The Electronic Engine Control (EEC) simplifies thrust management procedures. Having the EEC functioning does not relieve the pilots from monitoring the engine parameters and verifying proper thrust is obtained.

High thrust settings from jet engine blast over unpaved surfaces or thin asphalt pavement intended only to support occasional airplane movements can cause structural blast damage from loose rocks, dislodged asphalt pieces, and other foreign objects. Ensure run ups and takeoff operations are only conducted over well maintained paved surfaces and runways.

Initiating Takeoff Roll

Autothrottle and flight director use is recommended for all takeoffs. However, do not follow F/D commands until after liftoff.

A rolling takeoff procedure is recommended for setting takeoff thrust. It expedites the takeoff and reduces the risk of foreign object damage or engine surge/stall due to a tailwind or crosswind. Flight test and analysis prove that the change in takeoff roll distance due to the rolling takeoff procedure is negligible when compared to a standing takeoff.

Rolling takeoffs are accomplished in two ways:

- if cleared for takeoff before or while entering the runway, maintain normal taxi speed. When the airplane is aligned with the runway centerline ensure the nose wheel steering wheel is released and apply takeoff thrust by advancing the thrust levers to just above idle (40%N1). Allow the engines to stabilize momentarily then promptly advance the thrust levers to takeoff thrust (autothrottle TO/GA). There is no need to stop the airplane before increasing thrust.
- if holding in position on the runway, ensure the nose wheel steering wheel is released, release brakes, then apply takeoff thrust as described above.

Note: Brakes are not normally held with thrust above idle unless a static run-up in icing conditions is required.

A standing takeoff procedure may be accomplished by holding the brakes until the engines are stabilized, ensure the nose wheel steering wheel is released, then release the brakes and promptly advance the thrust levers to takeoff thrust (autothrottle TO/GA).

Allowing the engines to stabilize provides uniform engine acceleration to takeoff thrust and minimizes directional control problems. This is particularly important if crosswinds exist or the runway surface is slippery. The exact initial setting is not as important as setting symmetrical thrust.

Note: Allowing the engines to stabilize for more than approximately 2 seconds before advancing thrust levers to takeoff thrust may adversely affect takeoff distance.

If thrust is to be set manually, smoothly advance thrust levers toward takeoff thrust. Final thrust adjustments should be made, with reference to the digital readouts, by 60 knots.

During takeoff, if an engine exceedance occurs after thrust is set and the decision is made to continue the takeoff, do not retard the thrust lever in an attempt to control the exceedance. Retarding the thrust levers after thrust is set invalidates takeoff performance. When the PF judges that altitude (minimum 400 feet AGL) and airspeed are acceptable, the thrust lever should be retarded until the exceedance is within limits and the appropriate NNC accomplished.

737 NG Flight Crew Training Manual

Use of the nose wheel steering wheel is not recommended above 30 knots. However, pilots must use caution when using the nose wheel steering wheel above 20 knots to avoid over-controlling the nose wheels resulting in possible loss of directional control. Limited circumstances such as inoperative rudder pedal steering may require the use of the nose wheel steering wheel at low speeds during takeoff and landing when the rudder is not effective. Reference the airplane Dispatch Deviations Guide (DDG) for more information concerning operation with rudder pedal steering inoperative.

Light forward pressure is held on the control column. Keep the airplane on centerline with rudder pedal steering and rudder. The rudder becomes effective between 40 and 60 knots. Maximum nose wheel steering effectiveness is available when above taxi speeds by using rudder pedal steering.

Regardless of which pilot is making the takeoff, the captain should keep one hand on the thrust levers until V1 in order to respond quickly to a rejected takeoff condition. After V1, the captain's hand should be removed from the thrust levers.

The PM should monitor engine instruments and airspeed indications during the takeoff roll and announce any abnormalities. The PM should announce passing 80 knots and the PF should verify that his airspeed indicator is in agreement.

A pitot system blocked by protective covers or foreign objects can result in no airspeed indication, or airspeed indications that vary between instruments. It is important that aircrews ensure airspeed indicators are functioning and reasonable at the 80 knot callout. If the accuracy of either primary airspeed indication is in question, reference the standby airspeed indicator. Another source of speed information is the ground speed indication. Early recognition of a malfunction is important in making a sound go/stop decision. Refer to the Airspeed Unreliable section in chapter 8 for an expanded discussion of this subject.

The PM should verify that takeoff thrust has been set and the throttle hold mode (THR HLD) is engaged. A momentary autothrottle overshoot of 4% N1 may occur but thrust should stabilize at +/- 2% N1, after THR HLD. Thrust should be adjusted by the PM, if required, to - 0% + 1% target N1. Once THR HLD annunciates, the autothrottle cannot change thrust lever position, but thrust levers can be positioned manually. The THR HLD mode remains engaged until another thrust mode is selected.

Note: Takeoff into headwind of 20 knots or greater may result in THR HLD before the autothrottle can make final thrust adjustments.



The THR HLD mode protects against thrust lever movement if a system fault occurs. Lack of the THR HLD annunciation means the protective feature may not be active. If THR HLD annunciation does not appear, no crew action is required unless a subsequent system fault causes unwanted thrust lever movement. As with any autothrottle malfunction, the autothrottle should then be disconnected and desired thrust set manually.

If full thrust is desired when THR HLD mode is displayed, the thrust levers must be manually advanced. When making a V1(MCG)-limited takeoff, do not exceed the fixed derate thrust limit except in an emergency.

After the airplane is in the air, pushing a TO/GA switch advances the thrust to maximum available thrust and TO/GA is annunciated.

Initiating Takeoff Roll Using HUD System

Normal procedures apply, however, pilots must be aware that the captain's attention is devoted almost exclusively to outside/HUD cues. This requires that the first officer's attention be devoted to head down instruments more than during the normal takeoff roll.

The captain monitors the takeoff roll by using visual cues and HUD symbology. Use HUD guidance symbology, runway lighting and runway markings to maintain runway centerline. Rotate using the airplane reference symbol on the HUD.

Rotation and Liftoff - All Engines

Takeoff speeds are established based on minimum control speed, stall speed, and tail clearance margins. Shorter bodied airplanes are normally governed by stall speed margin while longer bodied airplanes are normally limited by tail clearance margin. When a smooth continuous rotation is initiated at VR, tail clearance margin is assured because computed takeoff speeds depicted in the QRH, airport analysis, or FMC, are developed to provide adequate tail clearance.

Above 80 knots, relax the forward control column pressure to the neutral position. For optimum takeoff and initial climb performance, initiate a smooth continuous rotation at VR toward 15° of pitch attitude. The use of stabilizer trim during rotation is not recommended. After liftoff use the flight director as the primary pitch reference cross checking indicated airspeed and other flight instruments.

Note: Do not adjust takeoff speeds or rotation rates to compensate for increased body length.

With a consistent rotation technique, where the pilot uses approximately equal control forces and similar visual cues, the resultant rotation rate differs slightly depending upon airplane body length.

Using the technique above, liftoff attitude is achieved in approximately 3 to 4 seconds. Resultant rotation rates vary from 2 to 3 degrees/second with rates being lowest on longer airplanes.

Note: The flight director pitch command is not used for rotation.

Typical Rotation, All Engines

The following figure shows typical rotation with all engines operating.

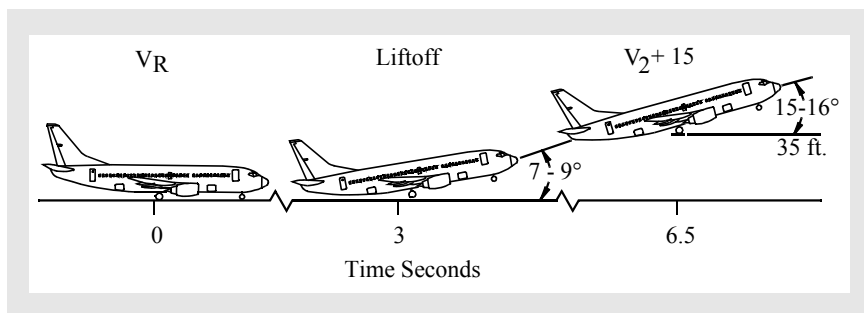

Retract the landing gear after a positive rate of climb is indicated on the altimeter. Retract flaps in accordance with the technique described in this chapter.

Typical Takeoff Tail Clearance

The following diagram and table show the effect of flap position on liftoff pitch attitude and minimum tail clearance during takeoff. Additionally, the last column shows the pitch attitude for tail contact with wheels on the runway and landing gear struts extended. For a discussion of tail strike procedures see chapter 8 and the FCOM.

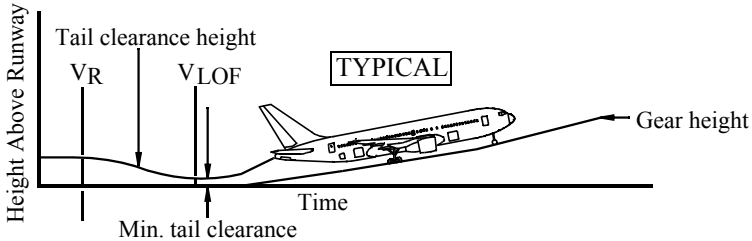

Model	Flap	Liftoff Attitude (degrees)	Minimum Tail Clearance inches (cm)	Tail Strike Pitch Attitude (degrees)
737-600	1	9.0	28 (71)	16.2
	5	9.0	28 (71)	
	10	8.8	29 (73)	
	15	8.7	30 (76)	
	25	8.6	32 (81)	
737-700	1	9.1	29 (73)	14.7
	5	9.1	29 (73)	
	10	8.9	30 (76)	
	15	8.7	31 (79)	
	25	8.5	32 (81)	

737 NG Flight Crew Training Manual

Model	Flap	Liftoff Attitude (degrees)	Minimum Tail Clearance inches (cm)	Tail Strike Pitch Attitude (degrees)
737-800	1	8.2	20 (51)	11.0
	5	8.2	20 (51)	
	10	8.0	22 (56)	
	15	7.8	23 (58)	
	25	7.6	25 (64)	
737-900	1	7.7	20 (51)	10.0
	5	7.6	20 (51)	
	10	7.4	22 (56)	
	15	7.2	23 (58)	
	25	7.0	25 (64)	

Note: Flaps 1 and 5 (-800/900) takeoffs have the least clearance. Consider using a larger flap setting for takeoffs at light gross weights. Because of the short fuselage, aft fuselage contact is unlikely in the 737-600.

Effect of Rotation Speed and Pitch Rate on Liftoff

Takeoff and initial climb performance depend on rotating at the correct airspeed and proper rate to the rotation target attitude. Early or rapid rotation may cause a tail strike. Late, slow, or under-rotation increases takeoff ground roll. Any improper rotation decreases initial climb flight path.

An improper rotation can have an effect on the command speed after liftoff. If the rotation is delayed beyond $V_2 + 20$, the speed commanded by the flight director is rotation speed up to a maximum of $V_2 + 25$. An earlier liftoff does not affect the commanded initial climb speed, however, either case degrades overall takeoff performance.

The following diagram shows how a slow or under rotation during takeoff increases the distance to a height of 35 feet compared to a normal rotation.

Slow or Under Rotation (Typical)

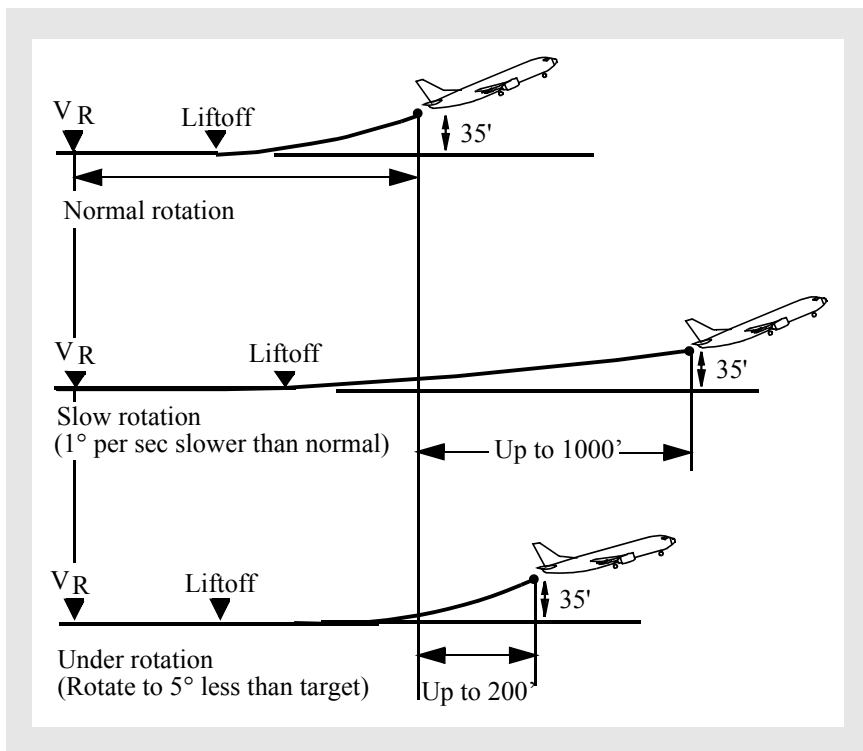

Center-Of-Gravity (CG) Effects

When taking off at light weight and with an aft CG, the combination of full thrust, rapid thrust application, and sudden brake release may tend to pitch the nose up, reducing nosewheel steering effectiveness. With CG at or near the aft limit, maintain forward pressure on the control column until 80 knots to increase nosewheel steering effectiveness. Above 80 knots, relax the forward control column pressure to the neutral position. At light weight and aft CG, use of reduced thrust and rolling takeoff technique is recommended whenever possible. The rudder becomes effective between 40 and 60 knots.

Operation with Alternate Forward Center of Gravity Limit for Takeoff

Takeoff performance is based on the forward CG limitations as defined in the AFM. However, takeoff performance can be improved by taking credit for an alternate (further aft) forward CG limit if shown in the AFM. Use of this data provides higher performance-limited takeoff weights than the basic AFM performance data.

Typically alternate forward CG is used to increase performance-limited takeoff weight for field length, climb or obstacle limited departures. Another potential benefit of alternate forward CG is to allow greater thrust reduction which increases engine reliability and reduces engine maintenance costs. However, this improved performance capability is only available if the airline has the certified data in their AFM and has approval from their regulatory agency to operate the airplane at an alternate forward CG limit.

A more aft CG increases the lift available at a given angle of attack due to the reduction in nose up trim required from the horizontal stabilizer. This allows VR and V2 to be reduced, which in turn reduces the field length required for takeoff. Reduction in field length required can also permit an increased field length limited weight. In most instances this reduction in nose up trim also results in a decrease in drag which improves the airplane's climb capability.

Note: The FMC calculated takeoff speeds and QRH takeoff speeds are not valid for operations using alternate forward CG. Takeoff speeds must be calculated using alternate forward CG performance data normally provided by dispatch or flight operations.

Crosswind Takeoff

The crosswind guidelines shown below were derived through flight test data, engineering analysis, and flight simulator evaluations.

Note: Engine surge can occur with a strong crosswind component if takeoff thrust is set before brake release. Therefore, the rolling takeoff procedure is strongly advised when crosswinds exceed 20 knots.

Takeoff Crosswind Guidelines

Crosswind guidelines are not considered limitations. Crosswind guidelines are provided to assist operators in establishing their own crosswind policies.

Takeoff crosswind guidelines are based on the most adverse airplane loading (light weight and aft center of gravity) and assume an engine out RTO and proper pilot technique. On slippery runways, crosswind guidelines are a function of runway surface condition.

Runway Condition	Crosswind - Knots*
	without / with winglets
Dry	36 / 34
Wet	25
Standing Water/Slush	15
Snow - No Melting **	25
Ice - No Melting **	15

*Winds measured at 33 feet (10 m) tower height and apply for runways 148 feet (45m) or greater in width.

** Takeoff on untreated ice or snow should only be attempted when no melting is present.

Directional Control

Initial runway alignment and smooth symmetrical thrust application result in good crosswind control capability during takeoff. Light forward pressure on the control column during the initial phase of takeoff roll (below approximately 80 knots) increases nose wheel steering effectiveness. Any deviation from the centerline during thrust application should be countered with immediate smooth and positive control inputs. Smooth rudder control inputs combined with small control wheel inputs result in a normal takeoff with no overcontrolling. Large control wheel inputs can have an adverse effect on directional control near V₁(MCG) due to the additional drag of the extended spoilers.

Note: With wet or slippery runway conditions, the PM should give special attention to ensuring the engines have symmetrically balanced thrust indications.

Rotation and Takeoff

Maintain wings level during the takeoff roll by applying control wheel displacement into the wind. During rotation continue to apply control wheel in the displaced position to keep the wings level during liftoff. The airplane is in a sideslip with crossed controls at this point. A slow, smooth recovery from this sideslip is accomplished after liftoff by slowly neutralizing the control wheel and rudder pedals.

Gusty Wind and Strong Crosswind Conditions

For takeoff in gusty or strong crosswind conditions, use of a higher thrust setting than the minimum required is recommended. When the prevailing wind is at or near 90° to the runway, the possibility of wind shifts resulting in gusty tailwind components during rotation or liftoff increases. During this condition, consider the use of thrust settings close to or at maximum takeoff thrust. The use of a higher takeoff thrust setting reduces the required runway length and minimizes the airplane exposure to gusty conditions during rotation, liftoff, and initial climb.

Avoid rotation during a gust. If a gust is experienced near VR, as indicated by stagnant airspeed or rapid airspeed acceleration, momentarily delay rotation. This slight delay allows the airplane additional time to accelerate through the gust and the resulting additional airspeed improves the tail clearance margin. Do not rotate early or use a higher than normal rotation rate in an attempt to clear the ground and reduce the gust effect because this reduces tail clearance margins. Limit control wheel input to that required to keep the wings level. Use of excessive control wheel may cause spoilers to rise which has the effect of reducing tail clearance. All of these factors provide maximum energy to accelerate through gusts while maintaining tail clearance margins at liftoff. The airplane is in a sideslip with crossed controls at this point. A slow, smooth recovery from this sideslip is accomplished after liftoff by slowly neutralizing the control wheel and rudder pedals.

Reduced Thrust Takeoff

Many operators prefer a less than maximum thrust takeoff whenever performance limits and noise abatement procedures permit. The reduced thrust takeoff lowers EGT and extends engine life.

The reduced thrust takeoff may be done using the Assumed Temperature Method, a Fixed Derate, or a combination of both. Regardless of the method, use the takeoff speeds provided by the airport analysis, FMC (if available), QRH (PI chapter), Flight Planning and Performance Manual (FPPM), AFM, or other approved source corresponding to the assumed (higher) temperature and/or selected derate.

Assumed Temperature Method (ATM)

This method achieves a takeoff thrust less than the maximum takeoff thrust by assuming a temperature that is higher than the actual temperature. The thrust reduction authorized by most regulatory agencies is limited to 25% below the maximum takeoff thrust.

The primary thrust setting parameter (N1) is not considered a limitation. If conditions are encountered during the takeoff where additional thrust is desired, such as windshear, the crew should not hesitate to manually advance thrust levers to maximum takeoff thrust.

The assumed temperature method of computing reduced thrust takeoff performance is always conservative and provides performance equal to or better than the performance obtained if actually operating at the assumed temperature. This is because the true airspeed of the airplane is lower than would be the case if the actual temperature were equal to the assumed temperature.

737 NG Flight Crew Training Manual

Do not use the ATM if conditions that affect braking such as a runway contaminated by slush, snow, standing water, or ice exist, or if potential windshear conditions exist. ATM procedures are allowed on a wet runway if suitable performance accountability is made for the increased stopping distance on a wet surface.

Note: An increase in elevator column force during rotation and initial climb may be required for ATM takeoffs.

Fixed Derate

This method uses a takeoff thrust less than maximum takeoff thrust for which complete and independent performance data are provided in the AFM. Derated thrust is obtained by selection of a fixed takeoff derate in the FMC.

The fixed derate is considered a limitation for takeoff. Thrust levers should not be advanced beyond the fixed derate limit unless conditions are encountered during the takeoff where additional thrust is needed on both engines, such as windshear. A thrust increase following an engine failure could result in a loss of directional control.

Note: Although fixed derate takeoffs are permitted on wet or contaminated runways, provided takeoff performance accounts for runway surface conditions, they are not recommended if potential windshear conditions exist.

Combination Fixed Derate and ATM

This method uses a takeoff thrust less than the fixed derate takeoff thrust by first selecting a fixed takeoff derate from the FMC. This derate takeoff thrust is then further reduced by assuming a temperature that is higher than the actual temperature. In this case, the thrust reduction authorized by most regulatory agencies is limited to 25% below the derated takeoff thrust.

Improved Climb Performance Takeoff

When not field length limited, an increased climb limit weight is achieved by using the excess field length to accelerate to higher takeoff and climb speeds. This improves the climb gradient, thereby raising the climb limit and obstacle limited weights. V1, VR and V2 are increased to maintain consistent performance relationships. V1, VR and V2 must be obtained from dispatch or the airport analysis.

Low Visibility Takeoff

Low visibility takeoff operations, below landing minima, may require a takeoff alternate. When selecting a takeoff alternate, consideration should be given to unexpected events such as an engine failure or other non-normal situation that could affect landing minima at the takeoff alternate. Operators, who have authorization for engine inoperative Category II/III operations, may be authorized lower alternate minima.

With proper crew training and appropriate runway lighting, takeoffs with visibility as low as 500ft/150m RVR may be authorized (FAA). With takeoff guidance systems and centerline lighting that meets FAA or ICAO criteria for Category III operations, takeoffs with visibility as low as 300ft/75m RVR may be authorized. Regulatory agencies may impose takeoff crosswind limits specifically for low visibility takeoffs.

All RVR readings must be equal to or greater than required takeoff minima. If the touchdown or rollout RVR system is inoperative, the mid RVR may be substituted for the inoperative system. When the touchdown zone RVR is inoperative, pilot estimation of RVR may be authorized by regulatory agencies.

Adverse Runway Conditions

Slush, standing water, or deep snow reduces the airplane takeoff performance because of increased rolling resistance and the reduction in tire-to-ground friction.

Most operators specify weight reductions to the AFM field length and/or obstacle limited takeoff weight based upon the depth of powdery snow, slush, wet snow or standing water and a maximum depth where the takeoff should not be attempted.

Slush or standing water may cause damage to the airplane. The recommended maximum depth for slush, standing water, or wet snow is 0.5 inch (12.7 mm) on the runway. For dry snow the maximum depth is 4 inches (102 mm).

A slippery runway (wet, compact snow, ice) also increases stopping distance during a rejected takeoff. Takeoff performance and critical takeoff data are adjusted to fit the existing conditions. Check the airport analysis or the PI section of the QRH for takeoff performance changes with adverse runway conditions.

Note: If there is an element of uncertainty concerning the safety of an operation with adverse runway conditions, do not takeoff until the element of uncertainty is removed.

During wet runway or slippery conditions, the PM must give special attention to ensuring that the thrust on the engines advances symmetrically. Any tendency to deviate from the runway centerline must immediately be countered with steering action and, if required, slight differential thrust.

737 NG Flight Crew Training Manual

Forward pressure on the control column during the initial portion of the takeoff roll (below approximately 80 knots) increases nose wheel steering effectiveness.

During takeoffs on icy runways, lag in rudder pedal steering and possible nose wheel skidding must be anticipated. Keep the airplane on the centerline with rudder pedal steering and rudder. The rudder becomes effective between 40 - 60 knots. If deviations from the centerline cannot be controlled either during the start of the takeoff roll or until the rudder becomes effective, immediately reject the takeoff.

Effect of Deicing/Anti-Icing Fluids on Takeoff

Testing of undiluted Type II and Type IV fluids has shown that some of the fluid remains on the wing during takeoff rotation and during initial climb out. The residual fluid causes a temporary decrease in lift and increase in drag. These effects are more significant at lower ambient temperatures where the fluid tends to stay on the wing longer. Operators must comply with the lowest operational use temperatures provided by the fluid manufacturer to ensure a relatively clean wing.

No performance adjustments are required for the application of deicing/anti-icing fluids. Takeoff operations with reduced thrust based on derates and/or the assumed temperature method are permitted. Use normal rotation rates.

Federal Aviation Regulation (FAR) Takeoff Field Length

The FAR takeoff field length is the longest of the following:

- the distance required to accelerate with all engines, experience an engine failure 1 second prior to V₁, continue the takeoff and reach a point 35 feet above the runway at V₂ speed. (Accelerate-Go Distance).
- the distance required to accelerate with all engines, experience an event 1 second prior to V₁, recognize the event, initiate the stopping maneuver and stop within the confines of the runway (Accelerate-Stop Distance).
- 1.15 times the all engine takeoff distance required to reach a point 35 feet above the runway.

Stopping distance includes the distance traveled while initiating the stop and is based on the measured stopping capability as demonstrated during certification flight test.

During certification, maximum manual braking and speedbrakes are used. Thrust reversers are not used. Although reverse thrust and autobrakes are not used in determining the FAR accelerate-stop distance, thrust reversers and RTO autobrakes should be used during any operational rejected takeoff.

Calculating a V_1 speed that equates accelerate-go and accelerate-stop distances defines the minimum field length required for a given weight. This is known as a “balanced field length” and the associated V_1 speed is called the “balanced V_1 ”. The QRH and FMC provide takeoff speeds based on a balanced V_1 . If either an ATM or fixed derate reduced thrust takeoff is used, the QRH and FMC, if FMC takeoff speeds are available, will provide a balanced V_1 applicable to the lower thrust setting.

Takeoff gross weight must not exceed the climb limit weight, field limit weight, obstacle limit weight, tire speed limit, or brake energy limit. If the weight is limited by climb, obstacle, or brake considerations, it may be beneficial to use takeoff speeds that are different from the normal balanced takeoff speeds provided by the QRH or FMC. Examples of this include the use of:

- improved climb to increase climb or obstacle limited weights
- maximum V_1 policy to increase obstacle limited weights
- minimum V_1 policy to increase brake energy limited weights
- clearway or stopway to increase field or obstacle limited weights.

If the takeoff weight is not based on normal balanced V_1 , the QRH and FMC takeoff speeds are not applicable and the operator should provide the pilot with a method to obtain the appropriate takeoff speeds.

FAR Takeoff

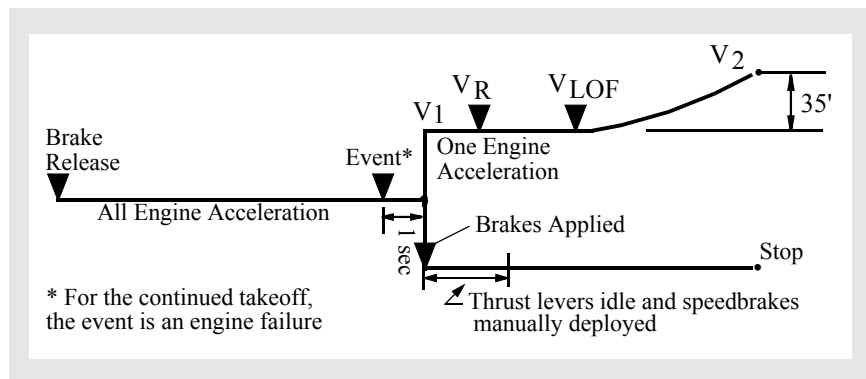

Note: The graphic above refers to dry runway conditions only. Refer to the AFM for detailed wet runway performance information.

Rejected Takeoff Decision

The total energy that must be dissipated during an RTO is proportional to the square of the airplane velocity. At low speeds (up to approximately 80 knots), the energy level is low. Therefore, the airplane should be stopped if an event occurs that would be considered undesirable for continued takeoff roll or flight.

Examples include Master Caution, unusual vibrations or tire failure.

Note: Refer to the Rejected Takeoff NNM in the QRH for guidance concerning the decision to reject a takeoff below and above 80 knots.

As the airspeed approaches V1 during a balanced field length takeoff, the effort required to stop can approach the airplane maximum stopping capability. Therefore, the decision to stop must be made before V1.

Historically, rejecting a takeoff near V1 has often resulted in the airplane stopping beyond the end of the runway. Common causes include initiating the RTO after V1 and failure to use maximum stopping capability (improper procedures/techniques). Effects of improper RTO execution are shown in the diagrams located in the RTO Execution Operational Margins section, this chapter. The maximum braking effort associated with an RTO is a more severe level of braking than most pilots experience in normal service.

Rejecting the takeoff after V1 is not recommended unless the captain judges the airplane incapable of flight. Even if excess runway remains after V1, there is no assurance that the brakes have the capacity to stop the airplane before the end of the runway.

There have been incidents where pilots have missed FMC alerting messages informing them that the takeoff speeds have been deleted or they have forgotten to set the airspeed bugs. If, during a takeoff, the crew discovers that the V speeds are not displayed and there are no other fault indications, the takeoff may be continued. The lack of displayed V speeds with no other fault indications does not fit any of the published criteria for rejecting a takeoff (refer to the Rejected Takeoff NNM in the QRH). In the absence of displayed V speeds, the PM should announce V1 and VR speeds to the PF at the appropriate times during the takeoff roll. The V2 speed should be displayed on the MCP and primary airspeed indicators. If neither pilot recalls the correct rotation speed, rotate the airplane 5 to 10 knots before the displayed V2 speed.

Rejected Takeoff Maneuver

The RTO maneuver is initiated during the takeoff roll to expeditiously stop the airplane on the runway. The PM should closely monitor essential instruments during the takeoff roll and immediately announce abnormalities, such as “ENGINE FIRE”, “ENGINE FAILURE”, or any adverse condition significantly affecting safety of flight. The decision to reject the takeoff is the responsibility of the captain, and must be made before V1 speed. If the captain is the PM, he should initiate the RTO and announce the abnormality simultaneously.

Note: If the decision is made to reject the takeoff, the flight crew should accomplish the rejected takeoff non-normal maneuver as described in the Maneuvers chapter of the QRH.

If the takeoff is rejected before the THR HLD annunciation, the autothrottle should be disengaged as the thrust levers are moved to idle. If the autothrottle is not disengaged, the thrust levers advance to the selected takeoff thrust position when released. After THR HLD is annunciated, the thrust levers, when retarded, remain in idle. For procedural consistency, disengage the autothrottles for all rejected takeoffs.

If rejecting due to fire, in windy conditions, consider positioning the airplane so the fire is on the downwind side. After an RTO, comply with brake cooling requirements before attempting a subsequent takeoff.

Go/Stop Decision Near V1

It was determined when the aviation industry produced the Takeoff Safety Training Aid in 1992 that the existing definition of V1 might have caused confusion because they did not make it clear that V1 is the maximum speed at which the flight crew must take the first action to reject a takeoff. The U.S. National Transportation Safety Board (NTSB) also noted in their 1990 study of rejected takeoff accidents, that the late initiation of rejected takeoffs was the leading cause of runway overrun accidents. As a result, the FAA has changed the definition of V1 in FAR Part 1 to read as follows:

- V1 means the maximum speed in the takeoff at which the pilot must take the first action (e.g., apply brakes, reduce thrust, deploy speedbrakes) to stop the airplane within the accelerate-stop distance and
- V1 also means the minimum speed in the takeoff, following a failure of an engine at which the pilot can continue the takeoff and achieve the required height above the takeoff surface within the takeoff distance.

Pilots know that V1 is fundamental to making the Go/Stop decision. Under runway limited conditions, if the reject procedure is initiated at V1, the airplane can be stopped before reaching the end of the runway. See RTO Execution Operational Margins diagrams for the consequences of initiating a reject after V1 and/or using improper procedures.

737 NG Flight Crew Training Manual

When the takeoff performance in the AFM is produced, it assumes an engine failure or event one-second before V₁. In a runway limited situation, this means the airplane reaches a height of 35 feet over the end of the runway if the decision is to continue the takeoff.

Within reasonable limits, even if the engine failure occurs earlier than the assumed one second before V₁, a decision to continue the takeoff will mean that the airplane is lower than 35 feet at the end of the runway, but it is still flying. For example, if the engine fails 2 seconds before V₁ and the decision is made to go, the airplane will reach a height of 15 to 20 feet at the end of the runway.

Although training has historically centered on engine failures as the primary reason to reject, statistics show engine thrust loss was involved in approximately one quarter of the accidents, and wheel or tire problems have caused almost as many accidents and incidents as have engine events. Other reasons that rejects occurred were for configuration, indication or light, crew coordination problems, bird strikes or ATC problems.

What's important to note here is that the majority of past RTO accidents were not engine failure events. Full takeoff power from all engines was available. With normal takeoff power, the airplane should easily reach a height of 150 feet over the end of the runway, and the pilot has the full length of the runway to stop the airplane if an air turnback is required.

Making the Go/Stop decision starts long before V₁. Early detection, good crew coordination and quick reaction are the keys to a successful takeoff or stop.

RTO Execution Operational Margins

A successful rejected takeoff at or near V₁ is dependent upon the captain making timely decisions and using the proper procedures.

The data in the following diagrams, extracted from the Takeoff Safety Training Aid, are provided as a reference. The individual diagrams show the approximate effects of various configuration items and procedural variations on the stopping performance of the airplane. These calculations are frequently based on estimated data and are intended for training discussion purposes only. The data are generally typical of the airplane at heavy weights, and except as noted otherwise, are based on the certified transition time.

Each condition is compared to the baseline condition. The estimated speed at the end of the runway and the estimated overrun distance are indicated at the right edge of each figure. The distance estimates assume an overrun area that can produce the same braking forces as the respective runway surface. If less than the baseline FAA accelerate-stop distance is required, the distance is denoted as a negative number.

737

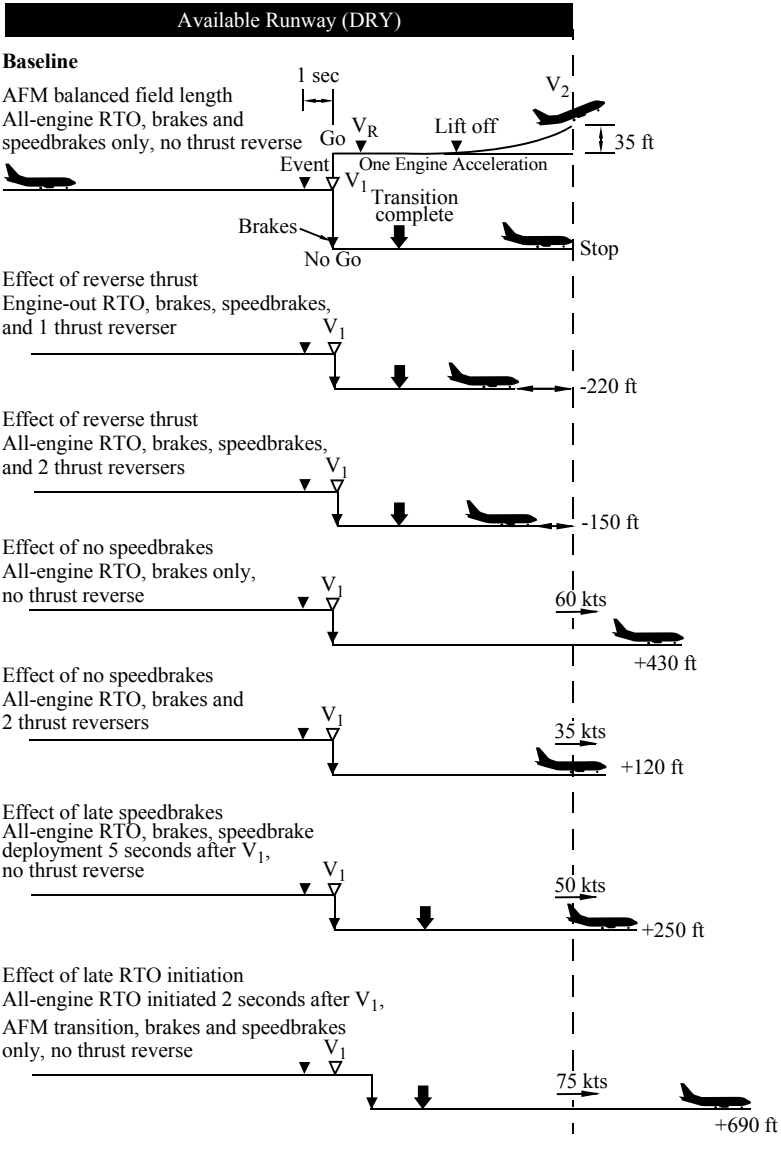

737 NG Flight Crew Training Manual

737

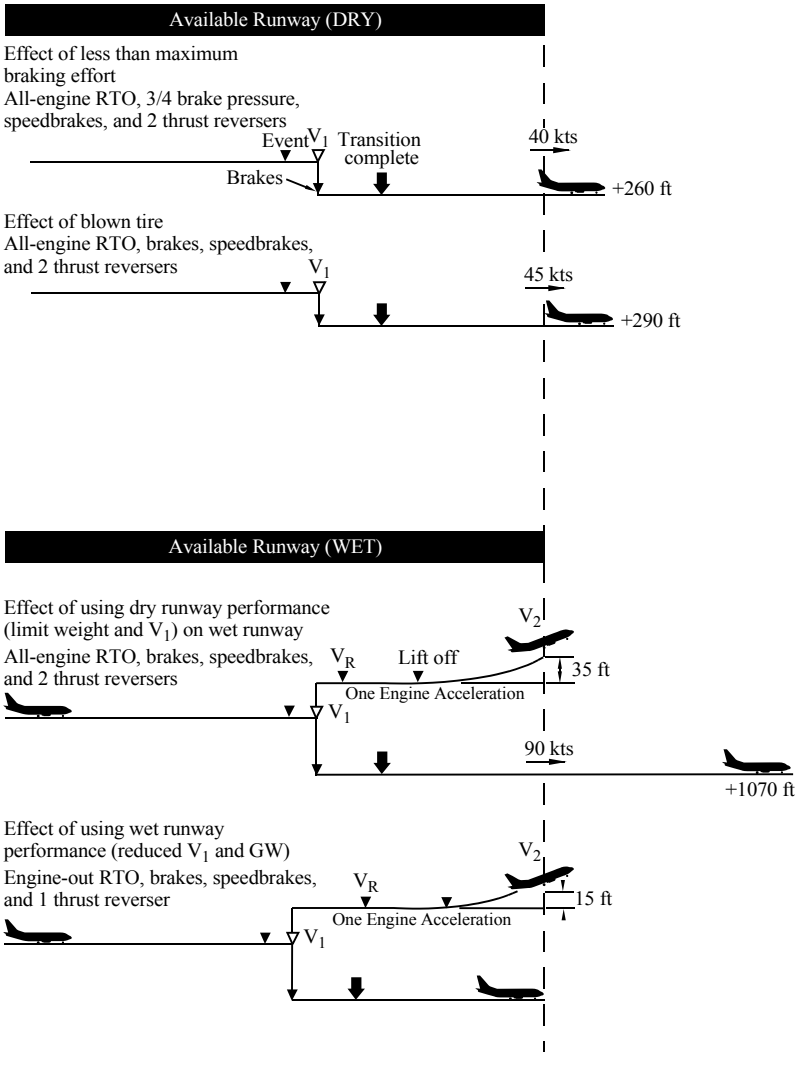

Initial Climb - All Engines

After liftoff use the flight director as the primary pitch reference cross checking indicated airspeed and other flight instruments. If the flight director is not used, indicated airspeed and attitude become the primary pitch references.

After liftoff, the flight director commands pitch to maintain an airspeed of $V_2 + 20$ knots until another pitch mode is engaged.

$V_2 + 20$ is the optimum climb speed with takeoff flaps. It results in the maximum altitude gain in the shortest distance from takeoff. Acceleration to higher speeds reduces the altitude gain. If airspeed exceeds $V_2 + 20$ during the initial climb, stop the acceleration but do not attempt to reduce airspeed to $V_2 + 20$. Any speed between $V_2 + 15$ and $V_2 + 25$ knots results in approximately the same takeoff profile. Crosscheck indicated airspeed for proper initial climb speed.

Retract the landing gear after a positive rate of climb is indicated on the altimeter. Do not apply brakes after becoming airborne. Braking is automatically applied when the landing gear lever is placed in the up position. After gear and flaps are retracted, the PM should verify the gear and flaps indications are normal.

Minimum Fuel Operation - Takeoff

The minimum fuel recommended for takeoff is trip fuel plus reserves. On very short flights this fuel quantity may not be enough to prevent forward fuel pump low pressure lights from illuminating after takeoff.

If any main tank fuel pump indicates low pressure do not turn off fuel pump switches. Avoid rapid acceleration of the airplane, reduce nose-up body attitude and maintain minimum nose-up body angle required for a safe climb gradient.

Immediate Turn after Takeoff - All Engines

Obstacle clearance, noise abatement, or departure procedures may require an immediate turn after takeoff. Initiate the turn at the appropriate altitude (normally at least 400 feet AGL) and maintain $V_2 + 15$ to $V_2 + 25$ with takeoff flaps.

Note: A maximum bank angle of 30° is permitted at $V_2 + 15$ knots with takeoff flaps.

After completing the turn, and at or above flap retraction altitude, accelerate and retract flaps while climbing.

Note: The possibility of an engine failure along the departure track must be considered. Special engine out procedures, if available, are preferable to a takeoff weight reduction to ensure all obstacles are cleared.

Roll Modes

After takeoff and climb is stabilized, select LNAV (if not selected before takeoff) after passing 400 feet AGL. If LNAV is selected for takeoff, LNAV guidance becomes active at 50 feet AGL if the active leg is within 3.0 NM and 5° of the runway heading. If the departure procedure or route does not begin at the end of the runway, it may be necessary to use the HDG SEL mode at 400 feet AGL to intercept the desired track for LNAV capture. When the departure procedure is not a part of the active flight plan, use HDG SEL or VOR LOC mode. When an immediate turn after takeoff is necessary, the desired heading may be preset before takeoff.

Note: For all airplanes equipped with the HDG SEL takeoff option, leave runway heading selected until turn initiation.

Nav aids and appropriate radials or tracks required for use during the departure may be displayed on the navigation display using the FIX page feature and/or VOR/ADF switches on the EFIS control panel. Use of the STA and WPT switches on the EFIS control panel provides additional information on the navigation display.

Autopilot Engagement

The autopilot is FAA certified to allow engagement at or above 400 feet AGL after takeoff. Other regulations or airline operating directives may specify a different minimum altitude. The airplane should be in trim, and the flight director commands should be satisfied before autopilot engagement. This prevents unwanted changes from the desired flight path during autopilot engagement.

Flap Retraction Schedule

During training flights, 1,000 feet AFE is normally used as the acceleration height to initiate thrust reduction and flap retraction. For noise abatement considerations during line operations, thrust reduction typically occurs at approximately 1,500 feet AFE and acceleration typically occurs between 1,500 and 3,000 feet AFE, or as specified by individual airport noise abatement procedures.

At thrust reduction altitude, select or verify that climb thrust is set. At acceleration height, set flaps up maneuvering speed and retract flaps on the Flap Retraction Schedule.

Begin flap retraction at $V_2 + 15$ knots, except for a flaps 1 takeoff. For a flaps 1 takeoff, begin flap retraction when reaching the flaps 1 maneuvering speed.

With airspeed increasing, subsequent flap retractions should be initiated:

- when airspeed reaches the maneuvering speed (number) for the existing flap position.



For flaps up maneuvering, maintain at least:

- “UP”

Note: The maneuver speed provides margin to stick shaker for at least an inadvertent 15° overshoot beyond the normal 25° angle of bank.

With flaps up and above 3,000 feet AGL, select VNAV or set the desired climb speed in the MCP speed window. Before selecting VNAV, flaps should be retracted because VNAV does not provide overspeed protection for the leading edge devices.

Takeoff Flap Retraction Speed Schedule

T/O Flaps	Select Flaps	Speed (knots)
25	15	V2 + 15
	5	“15”
	1	“5”
	UP	“1”
15 or 10	5	V2 + 15
	1	“5”
	UP	“1”
5	1	V2 + 15
	UP	“1”
1	UP	“1”

- “UP” - Flaps up maneuvering speed.
- “1”, “5”, “10”, “15”, “25” - Number corresponding to flap maneuvering speed.

Note: Limit bank angle to 15° until reaching V2 + 15.

Noise Abatement Takeoff

Normal takeoff procedures satisfy typical noise abatement requirements. Maintain flaps up maneuvering speed until the noise abatement profile is satisfied, until clear of obstacles or above any minimum crossing altitude. This is normally achieved through the FMC speed restriction entered on the CLB page. It may be also be accomplished using speed intervention (as installed) or LVL CHG.

Note: Specific local airport procedures should be followed.

Takeoff - Engine Failure

General

Differences between normal and engine out profiles are few. One engine out controllability is excellent during takeoff roll and after liftoff. Minimum control speed in the air is below VR and VREF.

Engine Failure Recognition

An engine failure at or after V1 initially affects yaw much like a crosswind effect. Vibration and noise from the affected engine may be apparent and the onset of the yaw may be rapid.

The airplane heading is the best indicator of the correct rudder pedal input. To counter the thrust asymmetry due to an engine failure, stop the yaw with rudder. Flying with lateral control wheel displacement or with excessive aileron trim causes spoilers to be raised.

Rotation and Liftoff - One Engine Inoperative

If an engine fails between V1 and liftoff, maintain directional control by smoothly applying rudder proportionate with thrust decay.

During a normal all engine takeoff, a smooth continuous rotation toward 15° of pitch is initiated at VR. With an engine inoperative, a smooth continuous rotation is also initiated at VR; however, the target pitch attitude is approximately 2° to 3° below the normal all engine pitch attitude. The rate of rotation with an engine inoperative is also slightly slower (1/2° per second less) than that for a normal takeoff. After liftoff adjust pitch attitude to maintain the desired speed.

If the engine failure occurs at or after liftoff apply rudder and aileron to control heading and keep the wings level. In flight, correct rudder input approximately centers the control wheel. To center the control wheel, rudder is required in the direction that the control wheel is displaced. This approximates a minimum drag configuration.

Typical Rotation - One Engine Inoperative

Liftoff attitude depicted in the following tables should be achieved in approximately 5 seconds. Adjust pitch attitude, as needed, to maintain desired airspeed of V2 to V2+20 knots.

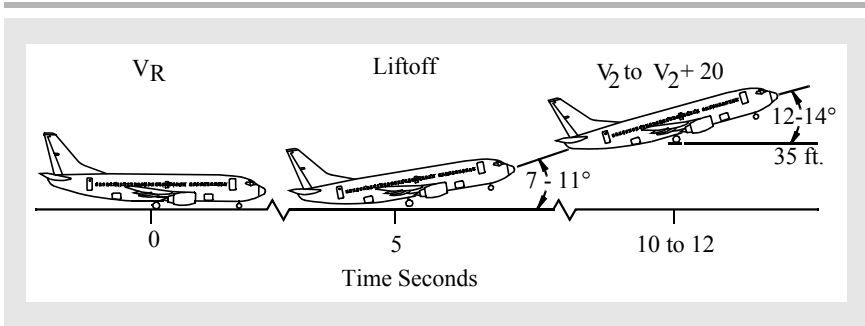

Retract the landing gear after a positive rate of climb is indicated on the altimeter.

Retract flaps in accordance with the technique described in this chapter.

737 NG Flight Crew Training Manual
Typical Takeoff Tail Clearance - One Engine Inoperative

The following diagram and table show the effect of flap position on liftoff pitch attitude and minimum tail clearance during takeoff with one engine inoperative. Additionally, the last column shows the pitch attitude for tail contact with wheels on the runway and landing gear struts extended. The tail strike pitch attitude remains the same as during takeoffs with all engines operating. For a discussion of tail strike procedures, see chapter 8 and the FCOM.

Note: Use of flap 1 as a takeoff flap setting is restricted to airplanes delivered with this capability or to airplanes having flap 1 installed as a takeoff flap setting.

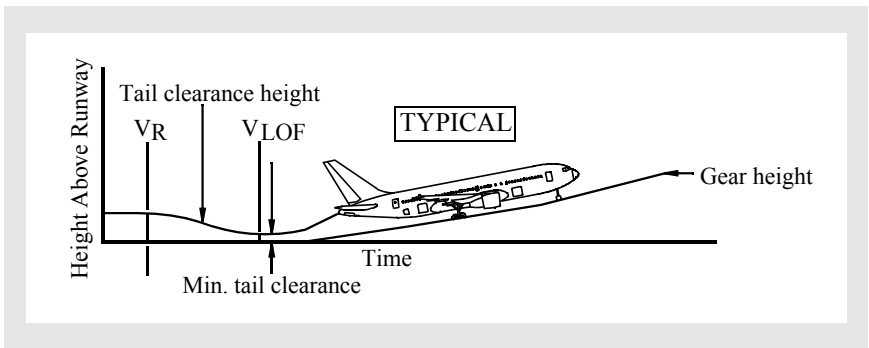



737 NG Flight Crew Training Manual

Model	Flap	Liftoff Attitude (degrees)	Minimum Tail Clearance inches (cm)	Tail Strike Pitch Attitude (degrees)
737-600	1	11.0	24 (61)	16.2
	5	11.0	24 (61)	
	10	10.8	25 (64)	
	15	10.5	26 (66)	
	25	10.2	28 (71)	
737-700	1	11.0	18 (46)	14.7
	5	11.0	18 (46)	
	10	10.8	19 (48)	
	15	10.6	21 (53)	
	25	10.2	23 (58)	
737-800	1	8.9	10 (25)	11.0
	5	8.9	10 (25)	
	10	8.7	10 (25)	
	15	8.5	13 (33)	
	25	8.3	15 (38)	
737-900	1	8.4	13 (33)	10.0
	5	8.3	13 (33)	
	10	8.1	13 (33)	
	15	7.8	16 (41)	
	25	7.6	18 (46)	

Initial Climb - One Engine Inoperative

The initial climb attitude should be adjusted to maintain a minimum of V_2 and a positive climb. After liftoff the flight director provides proper pitch guidance. Cross check indicated airspeed, vertical speed and other flight instruments. The flight director commands a minimum of V_2 , or the existing speed up to a maximum of $V_2 + 20$.

If the flight director is not used, indicated airspeed and attitude become the primary pitch references.

Retract the landing gear after a positive rate of climb is indicated on the altimeter. The initial climb attitude should be adjusted to maintain a minimum of V_2 . If an engine fails at an airspeed between V_2 and $V_2 + 20$, climb at the airspeed at which the failure occurred. If engine failure occurs above $V_2 + 20$, increase pitch to reduce airspeed to $V_2 + 20$ and maintain until flap retraction altitude.

The flight director roll mode commands wings level or HDG SEL (as installed) after liftoff until LNAV engagement or another roll mode is selected. If ground track is not consistent with desired flight path, use HDG SEL/LNAV to achieve the desired track.

Indications of an engine fire, impending engine breakup or approaching or exceeding engine limits, should be dealt with as soon as possible. Accomplish the appropriate recall checklist items as soon as the airplane is under control, the gear has been retracted and a safe altitude (typically 400 feet AGL or above) has been attained. Accomplish the reference checklist items after the flaps have been retracted and conditions permit.

If an engine failure has occurred during initial climb, accomplish the appropriate checklist after the flaps have been retracted and conditions permit.

Immediate Turn after Takeoff - One Engine Inoperative

Obstacle clearance or departure procedures may require a special engine out departure procedure. If an immediate turn is required, initiate the turn at the appropriate altitude (normally at least 400 feet AGL). Maintain V_2 to $V_2 + 15$ with takeoff flaps while maneuvering.

Note: Limit bank angle to 15° until $V_2 + 15$ knots. Bank angles up to 30° are permitted at $V_2 + 15$ knots with takeoff flaps.

After completing the turn, and at or above flap retraction altitude, accelerate and retract flaps.

Autopilot Engagement - One Engine Inoperative

When at a safe altitude above 400 feet AGL with correct rudder pedal or trim input, the autopilot may be engaged.

Flap Retraction - One Engine Inoperative

The minimum altitude for flap retraction with an engine inoperative is 400 feet AGL. During training, flap retraction is initiated at 1,000 feet AGL.

At engine out flap retraction altitude, select flaps up maneuvering speed on the MCP. Engine-out acceleration and climb capability for flap retraction are functions of airplane thrust to weight ratio. The flight director commands a near level or a slight climb (0-200 fpm) flap retraction segment. Accelerate and retract flaps on the flap-speed schedule.

If the flight director is not being used at flap retraction altitude, decrease pitch attitude to maintain approximately level flight while accelerating. Retract flaps on the flap-speed schedule.

As the airplane accelerates and flaps are retracted, adjust the rudder pedal position to maintain the control wheel centered and trim to relieve rudder pedal pressure.

Flaps Up - One Engine Inoperative

After flap retraction and at flaps up maneuvering speed, select LVL CHG, set maximum continuous thrust (CON) and continue the climb to the obstacle clearance altitude.

Initiate the appropriate engine failure non-normal checklist followed by the After Takeoff checklist when the flaps are up and thrust is set. Remain at flaps up maneuvering speed until all obstructions are cleared, then select the engine-out schedule from the CDU CLB page (depending on the next course of action).

Ensure the autothrottle is disconnected before reaching level off altitude. After level off, set thrust as needed.

Noise Abatement - One Engine Inoperative

When an engine failure occurs after takeoff, noise abatement is no longer a requirement.

Engine Failure During an ATM Takeoff

A reduced thrust takeoff using the ATM is based on a minimum climb gradient that clears all obstacles with an engine failure after V₁. If an engine failure occurs during an ATM takeoff, based on takeoff performance data, it is not necessary to set maximum thrust on the remaining engine. However, if maximum thrust is desired during an ATM takeoff, thrust on the operating engine may be increased to go-around thrust by manually advancing the thrust levers. The takeoff performance data provides a safe operating margin for minimum control speed on the ground (VMCG) when go-around thrust is set.

737 NG Flight Crew Training Manual

Advancing the operating engine to the maximum takeoff thrust provides additional performance margin. This additional performance margin is not a requirement of the reduced thrust takeoff certification and its use is at the discretion of the flight crew.

Engine Failure During a Fixed Derate Takeoff

During a fixed derate takeoff, the takeoff performance data at low gross weights may not provide a safe operating margin for VMCG if thrust levers are advanced beyond the fixed derate limit. A thrust increase following an engine failure, especially near V1, could result in a loss of directional control and should not be accomplished unless, in the opinion of the captain, terrain contact is imminent.

Engine Failure During a Combined Takeoff

During a combined fixed derate and ATM takeoff, the takeoff performance data is based on the fixed derate takeoff thrust before the assumed temperature reduction. The takeoff performance data provides a safe operating margin for minimum control speed on the ground (VMCG) when the fixed derate takeoff thrust is selected, but not beyond the fixed derate limit. A thrust increase beyond the fixed derate limit following an engine failure, especially near V1, could result in a loss of directional control and should not be accomplished unless, in the opinion of the captain, terrain contact is imminent.



Intentionally
Blank



Climb, Cruise, Descent and Holding
Table of Contents

Chapter 4
Section TOC

Preface 4.1

Climb 4.1

 Reduced Thrust Climb 4.1

 Climb Constraints 4.1

 Low Altitude Level Off 4.2

 Transition to Climb 4.2

 Climb Speed Determination 4.3

 Engine Icing During Climb 4.3

 Economy Climb 4.3

 Economy Climb Schedule - FMC Data Unavailable 4.4

 Maximum Rate Climb 4.4

 Maximum Angle Climb 4.4

 Engine Inoperative Climb 4.4

Cruise 4.5

 Maximum Altitude 4.5

 Optimum Altitude 4.6

 Cruise Speed Determination 4.7

 Step Climb 4.7

 Cruise Using HUD System 4.8

 Low Fuel Temperature 4.8

 Cruise Performance Economy 4.9

 Engine Inoperative Cruise/Driftdown 4.11

 High Altitude High Speed Flight 4.12

 ETOPS 4.12

 Polar Operations 4.14

Descent	4.16
Descent Speed Determination	4.16
Descent Path	4.16
Descent Constraints	4.16
Speed Intervention (As installed)	4.16
Descent Preparation Using HUD System	4.17
Descent Planning	4.17
Descent Rates	4.17
Speedbrakes	4.18
Flaps and Landing Gear	4.19
Speed Restrictions	4.19
Engine Icing During Descent	4.19
Holding	4.20
Procedure Holding	4.20
ICAO Holding Airspeeds (Maximum)	4.21
FAA Holding Airspeeds (Maximum)	4.21



Preface

This chapter outlines recommended operating practices and techniques used during climb, cruise, descent and holding. Loss of an engine during climb or cruise and engine inoperative cruise/driftdown is also addressed. The recommended operating practices and techniques discussed in this chapter improve crew coordination, enhance safety, and provide a basis for standardization.

Climb

Reduced Thrust Climb

Engine service life may be extended by operating the engines at less than full climb rated thrust.

The FMC provides two reduced thrust climb selections on the N1 LIMIT page:

- CLB 1 is approximately a 10% derate of climb thrust
- CLB 2 is approximately a 20% derate of climb thrust

Reduced thrust climb may also be automatically selected by the FMC depending upon the amount of thrust reduction made for takeoff by either the fixed derate or assumed temperature method.

Climb thrust reductions are gradually removed as the airplane climbs until full climb thrust is restored. If rate of climb should drop below approximately 500 feet per minute, the next higher climb rating should be selected.

Prior to takeoff, the pilot may override the automatically selected climb thrust limit after the takeoff selection has been completed by selecting another climb thrust limit on the N1 LIMIT page. When the automatically selected climb thrust limit is overridden, the previously selected takeoff derate is not affected.

Note: Use of reduced thrust for climb increases total trip fuel and should be evaluated by each operator.

Climb Constraints

Climb constraints may be automatically entered in the route when selecting a procedure, or manually entered through CDU entry. When the airplane levels off at an MCP altitude, that altitude is treated as a climb constraint by the FMC.

All hard altitude climb restrictions, including “at or below” constraints, should be set in the MCP altitude window. The next altitude may be set when the restriction has been satisfied or further clearance has been received. This procedure provides altitude alerting and ensures compliance with altitude clearance limits.

When relieved of constraints by ATC, use of LVL CHG or VNAV with MCP altitude intervention (as installed) is recommended in congested areas, or during times of high workload. Altitude intervention (as installed) is accomplished by selecting the next desired altitude in the MCP altitude window, pushing the MCP ALT INTV switch which deletes the altitude constraint and allows the airplane to climb to the MCP altitude.

Low Altitude Level Off

Occasionally a low altitude climb restriction is required after takeoff. This altitude restriction should be set in the MCP altitude window. When the airplane approaches this altitude, the mode annunciation changes to VNAV ALT (as installed) and the airplane levels off. For airplanes without VNAV ALT installed, the mode annunciation initially changes to ALT ACQ, then ALT HOLD.

Note: If ALT ACQ occurs before N1 is selected, automatic thrust reduction occurs and the autothrottle speed mode engages.

High Takeoff Thrust - Low Gross Weight

When accomplishing a low altitude level off following a takeoff using high takeoff thrust and at a low gross weight, the crew should consider the following factors:

- altitude capture can occur just after liftoff due to the proximity of the level off altitude and the high climb rate of the airplane
- the AFDS control laws limit F/D and autopilot pitch commands for passenger comfort
- there may not be enough altitude below the intended level off altitude to complete the normal capture profile and an overshoot may occur unless crew action is taken.

To prevent an altitude and/or airspeed overshoot, the crew should consider doing one or more of the following:

- use reduced thrust for takeoff at low weights whenever possible
- reduce from takeoff to climb thrust earlier than normal
- disconnect the AFDS and complete the level off manually if there is a possibility of an overshoot
- use manual thrust control as needed to manage speed and prevent flap overspeeds.

Transition to Climb

Maintain flaps up maneuvering speed until clear of obstacles or above minimum crossing altitudes. If there are no altitude or airspeed restrictions, accelerate to the desired climb speed schedule. The sooner the airplane can be accelerated to the climb speed schedule, the more time and fuel efficient the flight.

Climb Speed Determination

Enroute climb speed is automatically computed by the FMC and displayed on the climb page. It is also displayed as command speed when VNAV is engaged. Below the speed transition altitude the FMC targets the transition speed limit stored in the navigation data base for the departure airport (250 knots below 10,000 feet MSL in FAA. airspace), or flaps up maneuvering speed, whichever is higher. The FMC applies waypoint-related speed restrictions displayed on the LEGS pages, and altitude-related speed restrictions displayed on the climb page.

The FMC provides optimum climb speed modes for economy (ECON) operation and engine out (ENG OUT) operation. These optimum speeds can be changed before or during the climb. Selectable climb speed modes are also provided for maximum angle climb (MAX ANGLE) and maximum rate (MAX RATE) operation.

The ECON climb speed is a constant speed/constant Mach schedule optimized to obtain the minimum airplane operating cost. The constant Mach value is set equal to the economy cruise Mach calculated for the cruise altitude entered in the FMC.

For very low cruise altitudes the economy climb speed is increased above normal values to match the economy cruise speed at the entered cruise altitude. For ECON climb, the speed is a function of gross weight (predicted weight at top of climb), predicted top of climb wind, predicted top of climb temperature deviation from ISA, and cost index.

Engine Icing During Climb

Engine icing may form when not expected and may occur when there is no evidence of icing on the windshield or other parts of the airplane. Once ice starts to form, accumulation can build very rapidly. Although one bank of clouds may not cause icing, another bank, which is similar, may cause icing.

Note: The engine anti-icing system should be turned on whenever icing conditions exist or are anticipated. Failure to follow the recommended anti-ice procedures can result in engine stall, overtemperature or engine damage.

Economy Climb

The normal economy climb speed schedule of the FMC minimizes trip cost. It varies with gross weight and is influenced by cost index. The FMC generates a fixed speed schedule as a function of cost index and weight.

Economy climb speed normally exceeds 250 knots for all gross weights. FMC climb speed is limited to 250 knots below 10,000 feet (FAA Airspace), or a lower waypoint speed restriction, if entered. If the use of a higher speed below 10,000 feet is allowed, ECON speed provides additional cost savings.

Economy Climb Schedule - FMC Data Unavailable

- 250 knots/VREF 40 + 70, whichever is higher - Below 10,000 feet
- 280 knots/0.76M - Above 10,000 feet

Maximum Rate Climb

A maximum rate climb provides both high climb rates and minimum time to cruise altitude. Maximum rate climb can be approximated by using the following:

- flaps up Maneuver Speed + 50 knots until intercepting 0.76M

Note: The FMC provides maximum rate climb speeds.

Maximum Angle Climb

The FMC provides maximum angle climb speeds. Maximum angle climb speed is normally used for obstacle clearance, minimum crossing altitude or to reach a specified altitude in a minimum distance. It varies with gross weight and provides approximately the same climb gradient as flaps up maneuvering speed.

Engine Inoperative Climb

The engine inoperative climb speed is approximately maximum angle climb speed and varies with gross weight and altitude. After flap retraction and all obstructions are cleared, on the FMC ACT ECON CLB page, select ENG OUT followed by the prompt corresponding to the failed engine. This displays the MOD ENG OUT CLB page (ENG OUT CLB for FMC U10.3 and later) which provides advisory data for an engine out condition.

If a thrust loss occurs at other than takeoff thrust, set maximum continuous thrust on the operative engine and adjust the pitch to maintain airspeed.

Note: Selecting CON on the FMC N1 LIMIT page moves the N1 bug to maximum continuous thrust until another mode is selected or automatically engaged. Thrust must be manually set.

The MOD ENG OUT CLB (ENG OUT CLB for FMC 10.3 and later) page displays the N1 for maximum continuous thrust, maximum altitude and the engine out climb speed to cruise altitude, or maximum engine out altitude, whichever is lower. Leave thrust set at maximum continuous thrust until airspeed increases to the commanded value.

Note: If computed climb speeds are not available, use flaps up maneuvering speed and maximum continuous thrust.

Cruise

This section provides general guidance for the cruise portion of the flight for maximum passenger comfort and economy.

Maximum Altitude

Maximum altitude is the highest altitude at which the airplane can be operated. It is determined by three basic characteristics, which are unique to each airplane model. The FMC predicted maximum altitude is the lowest of:

- maximum certified altitude (structural) - determined during certification and is usually set by the pressurization load limits on the fuselage.
- thrust limited altitude - the altitude at which sufficient thrust is available to provide a specific minimum rate of climb. (Reference the Long Range Cruise Maximum Operating Altitude table in the PI chapter of the QRH). Depending on the thrust rating of the engines, the thrust limited altitude may be above or below the maneuver altitude capability.
- buffet or maneuver limited altitude - the altitude at which a specific maneuver margin exists prior to buffet onset. This altitude provides at least a 0.2g margin (33° bank) for FAA operations or a 0.3g margin (40° bank) for CAA/JAA operations prior to buffet.

Although each of these limits are checked by the FMC, available thrust may limit the ability to accomplish anything other than relatively minor maneuvering. The amber band limits do not provide an indication of maneuver capability as limited by available thrust.

To get the most accurate altitude limits from the FMC, ensure the following entries are accurate:

- airplane weight
- cruise CG
- temperature deviation at the cruise altitude.

For LNAV operation, the FMC provides a real-time bank angle limiting function. This function will protect the commanded bank angle from exceeding the current available thrust limit. This bank angle limiting protection is only available when in LNAV.

For operations other than LNAV, fly at least 10 knots above the lower amber band and use bank angles of 10° or less when operating at or near maximum altitude. If speed drops below the lower amber band, immediately increase speed by doing one or more of the following:

- reduce angle of bank
- increase thrust up to maximum continuous
- descend.

Turbulence at or near maximum altitude can momentarily increase the airplane's angle-of attack and activate the stick shaker. When flying at speeds near the lower amber band, any maneuvering will increase the load factor and further reduce the margin to buffet onset and stick shaker.

FMC fuel predictions are not available above the FMC maximum altitude and are not displayed on the CDU. VNAV is not available above FMC maximum altitude. Fuel burn at or above maximum altitude increases. Flight above this altitude is not recommended.

Optimum Altitude

Optimum altitude is the cruise altitude for minimum cost when operating in the ECON mode, and for minimum fuel burn when in the LRC or pilot-selected speed modes. In ECON mode, optimum altitude increases as either airplane weight or cost index decreases. In LRC or selected speed modes, optimum altitude increases as either airplane weight or speed decreases. On each flight, optimum altitude continues to increase as weight decreases during the flight.

For shorter trips, optimum altitude as defined above may not be achievable since the top of descent (T/D) point occurs prior to completing the climb to optimum altitude.

Trip altitude, as defined on the FMC PERF INIT page, further constrains optimum altitude by reducing the altitude for short trips until minimum cruise segment time is satisfied. This cruise time is typically one minute, but is operator selectable in the FMC by maintenance action. For short trips, operation at the trip altitude results in the minimum fuel/cost while also satisfying the minimum cruise time requirement.

Flight plans not constrained by short trip distance are typically based on conducting the cruise portion of the flight within plus or minus 2000 feet of optimum altitude. Since the optimum altitude increases as fuel is consumed during the flight, it is necessary to climb to a higher cruise altitude every few hours to achieve the flight plan fuel burn. This technique, referred to as Step Climb Cruise, is typically accomplished by initially climbing 2000 feet above optimum altitude and then cruising at that flight level until 2000 feet below optimum. For most flights, one or more step climbs may be required before reaching T/D. It may be especially advantageous to request an initial cruise altitude above optimum if altitude changes are difficult to obtain on specific routes. This minimizes the possibility of being held at a low altitude/high fuel consumption condition for long periods of time. The requested/accepted initial cruise altitude should be compared to the thrust limited or the maneuver margin limited altitudes. Remember, a cruise thrust limited altitude is dependent upon the cruise level temperature. If the cruise level temperature increases above the chart value for gross weight, maximum cruise thrust will not maintain desired cruise speed.

737 NG Flight Crew Training Manual

The selected cruise altitude should normally be as close to optimum as possible. Optimum altitude is the altitude that gives the minimum trip cost for a given trip length, cost index, and gross weight. It provides approximately a 1.5 load factor (approximately 48° bank to buffet onset) or better buffet margin. As deviation from optimum cruise altitude increases, performance economy deteriorates.

Some loss of thrust limited maneuver margin can be expected above optimum altitude. Levels 2000 feet above optimum altitude normally allows approximately 45° bank prior to buffet onset. The higher the airplane flies above optimum altitude, the more the thrust margin is reduced. Before accepting an altitude above optimum, determine that it will continue to be acceptable as the flight progresses under projected conditions of temperature and turbulence.

On airplanes with higher thrust engines, the altitude selection is most likely limited by maneuver margin to initial buffet. Projected temperature and turbulence conditions along the route of flight should be reviewed when requesting/accepting initial cruise altitude as well as subsequent step climbs.

Cruise Speed Determination

Cruise speed is automatically computed by the FMC and displayed on the CRZ page. It is also displayed by the command air speed when VNAV is engaged. The default cruise speed mode is economy (ECON) cruise. The pilot can also select long range cruise (LRC), engine out modes, or overwrite fixed Mach or CAS values on the CRZ page target speed line.

ECON cruise is a variable speed schedule that is a function of gross weight, cruise altitude, cost index, and headwind component. It is calculated to provide minimum operating cost for the entered cost index. Entry of zero for cost index results in maximum range cruise.

Headwinds increase the ECON CRZ speed. Tailwinds decrease ECON CRZ speed, but not below the zero wind maximum range cruise airspeed.

LRC is a variable speed schedule providing fuel mileage 1% less than the maximum available. The FMC does not apply wind corrections to LRC.

Required Time of Arrival (RTA) speed is generated to meet a time required at an RTA specified waypoint on the FMC LEGS page.

Step Climb

Optimum step points are a function of the route length, flight conditions, speed mode, present airplane altitude, STEP to altitude and gross weight.

The FMC does not compute an optimum step point. The crew must enter a STEP to altitude. The FMC then computes the ETA and distance to step climb point based upon gross weight. A fuel savings or penalty to destination is computed assuming the step climb is performed. Initiate a cruise climb to the new altitude as close as practicable to the step climb point.

Fuel for Enroute Climb

The additional fuel required for a 4,000 foot enroute climb varies from 300 to 500 lbs (135 to 225 kgs) depending on the airplane gross weight, initial altitude, air temperature, and climb speed. The fuel increment is largest for high gross weights and low initial altitudes. Additional fuel burn is offset by fuel savings in the descent. It is usually beneficial to climb to a higher altitude if recommended by the FMC or the flight plan, provided the wind information used is reliable.

Note: The fuel saved at higher altitude does not normally justify a step climb unless the cruise time of the higher altitude is approximately 20 minutes or longer.

Cruise Using HUD System

The HUD may be used at any altitude but horizon accuracy is limited above 25,000 feet.

Low Fuel Temperature

Fuel temperature changes relative to total air temperature. For example, extended operation at high cruise altitudes tends to reduce fuel temperature. In some cases the fuel temperature may approach the minimum fuel temperature limit.

Fuel freezing point should not be confused with fuel ice formation caused by frozen water particles. The fuel freezing point is the temperature at which the formation of wax crystals appears in the fuel. The Jet A fuel specification limits the freezing point to -40°C maximum, while the Jet A-1 limit is -47°C maximum. In the Former Soviet Union, the fuel is TS-1 or RT, which has a maximum freezing point of -50°C, which can be lower in some geographical regions. The actual uplifted freezing point for jet fuels varies by the geographical region in which the fuel is refined.

Unless the operator measures the actual freezing point of the loaded fuel at the dispatch station, the maximum specification freezing point must be used. At most airports, the measured fuel freezing point can yield a lower freezing point than the specification maximum freezing point. The actual delivered freezing temperature can be used if it is known. Pilots should keep in mind that some airports store fuel above ground and, in extremely low temperature conditions, the fuel may already be close to the minimum allowable temperature before being loaded.

For blends of fuels, use the most conservative freezing point of the fuel on board as the freezing point of the fuel mixture. This procedure should be used until 3 consecutive refuelings with a lower freezing point fuel have been completed. Then the lower freezing point may be used. If fuel freezing point is projected to be critical for the next flight segment, wing tank fuel should be transferred to the center wing tank before refueling. The freezing point of the fuel being loaded can then be used for that flight segment.

737 NG Flight Crew Training Manual

Fuel temperature should be maintained within AFM limitations as specified in the Limitations chapter of the FCOM.

Maintaining a minimum fuel temperature should not be a concern unless the fuel temperature approaches the minimum temperature limit. The rate of cooling of the fuel is approximately 3° C per hour, with a maximum of 12° C per hour possible under the most extreme conditions.

Total air temperature can be raised in the following three ways, used individually or in combination:

- climb or descend to a warmer air mass
- deviate to a warmer air mass
- increase Mach number.

Note: In most situations, warmer air can be reached by descending but there have been reports of warmer air at higher flight levels. Air temperature forecasts should be carefully evaluated when colder than normal temperatures are anticipated.

It takes from 15 minutes to one hour to stabilize the fuel temperature. In most cases, the required descent would be 3,000 to 5,000 feet below optimum altitude. In more severe cases, descent to altitudes of 25,000 feet to 30,000 feet might be required. An increase of 0.01 Mach results in an increase of 0.5° to 0.7° C total air temperature.

Cruise Performance Economy

The flight plan fuel burn from departure to destination is based on certain assumed conditions. These include takeoff gross weight, cruise altitude, route of flight, temperature, enroute winds, and cruise speed.

Actual fuel burn should be compared to the flight plan fuel burn throughout the flight.

The planned fuel burn can increase due to:

- temperature above planned
- a lower cruise altitude than planned
- cruise altitude more than 2,000 feet above optimum altitude
- speed faster than planned or appreciably slower than long range cruise speed when long range cruise was planned
- stronger headwind component
- fuel imbalance
- improperly trimmed airplane
- excessive thrust lever adjustments.

Cruise fuel penalties include:

- ISA + 10° C: 1% increase in trip fuel
- 2,000 feet above/below optimum altitude: 1% to 2% increase in trip fuel
- 4,000 feet below optimum altitude: 3% to 5% increase in trip fuel
- 8,000 feet below optimum altitude: 8% to 14% increase in trip fuel
- cruise speed 0.01M above LRC: 1% to 2% increase in trip fuel.

For cruise within 2,000 feet of optimum, long range cruise speed can be approximated by using 0.78M. Long range cruise also provides the best buffet margin at all cruise altitudes.

Note: If a discrepancy is discovered between actual fuel burn and flight plan fuel burn that cannot be explained by one of the items above, a fuel leak should be considered. Accomplish the applicable non-normal checklist.

Engine Inoperative Cruise/Driftdown

Performance of a non-normal checklist or sudden engine failure may lead to the requirement to perform a single engine driftdown.

If an engine failure occurs while at cruise altitude, it may be necessary to descend. The autothrottle should be disconnected and the thrust manually set to CON. On the FMC CRZ page, select the ENG OUT prompt, followed by the prompt corresponding to the failed engine. This displays MOD ENG OUT CRZ (ENG OUT CRZ for FMC U10.3 and later) and the FMC calculates engine out target speed and maximum engine out altitude at the current gross weight. The fields are updated as fuel is burned.

Set the MAX altitude in the MCP altitude window and the engine out target airspeed in the MCP IAS window. Allow airspeed to slow to engine out speed then engage LVL CHG. If the engine out target airspeed and maximum continuous thrust (MCT) are maintained, the airplane levels off above the original MAX altitude. However, the updated MAX altitude is displayed on the ENG OUT CRZ page. After viewing engine out data, select the ERASE prompt to return to the active CRZ page. With the MOD ENG OUT CRZ page selected, no other FMC data pages can be executed.

After level off at the target altitude, maintain MCT and allow the airplane to accelerate to the single engine long range cruise speed. Maintain this speed with manual thrust adjustments. Entering the new cruise altitude and airspeed on the ECON CRZ page updates the ETAs and Top of Descent predictions. Refer to Engine Out Familiarization, chapter 7, for trim techniques.

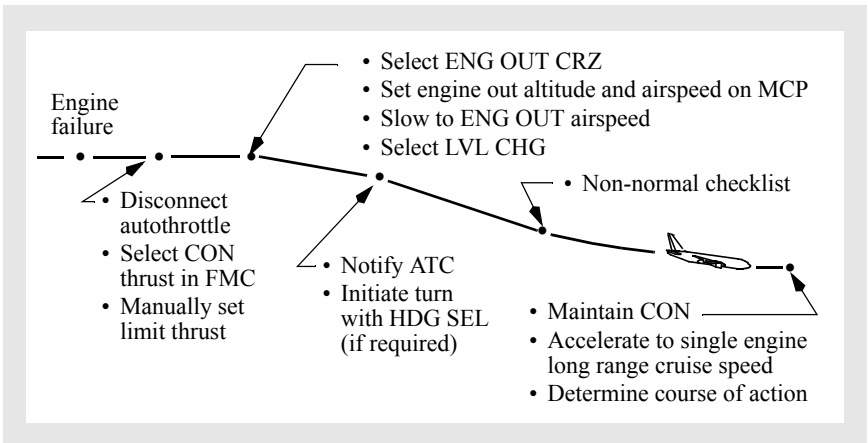

Note: If the airplane is at or below maximum ENG OUT altitude when an engine becomes inoperative, select the MOD ENG OUT CRZ (ENG OUT CRZ for FMC U10.3 and later). Maintain engine out cruise speed using manual thrust adjustments.

High Altitude High Speed Flight

The airplane exhibits excellent stability throughout the high altitude / high Mach range. Mach buffet is not normally encountered at high Mach cruise. The airplane does not have a Mach tuck tendency.

With Mach trim inoperative, the airplane exhibits a slight nose down trim change when accelerating to speeds approaching MMO, however, control force changes are light and easily managed. When the Mach trim system is operative, the nose down trim change is nearly imperceptible except by referencing the control column position.

As speed nears MMO, drag increases rapidly. At high weights, sufficient thrust may not be available to accelerate to MMO in level flight at normal cruising altitudes.

ETOPS

Extended Range Operation with Two Engine Airplanes (ETOPS) are those flights which include points at a flying distance greater than one hour (in still air) single engine cruise speed from an adequate airport. Improved technology and the increased reliability of two engine airplanes has prompted a re-examination of the rules governing their flights over oceans or desolate areas.

ETOPS Requirements and Approval

Operators conducting ETOPS are required to comply with the provisions of FAA Advisory Circular 120-42A or other applicable governing regulations. An airline must have an ETOPS configured airplane, and approved flight operations and maintenance programs in place to support ETOPS operations.

■ The Minimum Equipment List (MEL) and the Dispatch Deviations Guide (DDG) include dispatch relief levels appropriate to ETOPS.

The airline ensures that the ETOPS airplane is in compliance with the requirements of the appropriate Boeing Configuration, Maintenance and Procedures (CMP) documents. The airline's maintenance department must develop programs which monitor and report reliability of the engines, airframe and components. The Minimum Equipment List (MEL) and the Dispatch

■ Deviations Guide (DDG) have been expanded to address the improved redundancy levels and the additional equipment unique to ETOPS configured airplanes.

Flight and Performance

Crews undertaking ETOPS flights must be familiar with the suitable enroute alternates listed in the flight plan. These airports must meet ETOPS weather minima which require an incremental increase above conventional alternate minimums, and be located so as to ensure that the airplane can divert and land in the event of a system failure requiring a diversion.

Planning an ETOPS flight requires an understanding of the area of operations, critical fuel reserves, altitude capability, cruise performance tables and icing penalties. The Flight Planning and Performance Manual (FPPM) provides guidance to compute critical fuel reserves which are essential for the flight crew to satisfy the requirements of the ETOPS flight profile. The FPPM also provides single engine altitude capability and cruise and diversion fuel information at ETOPS planning speeds. This information is not included in the FCOM/QRH. Fuel reserve corrections must be made for winds, non-standard atmospheric conditions, performance deterioration caused by engines or airframe, and when needed, flight through forecast icing conditions.

Note: Critical fuel calculations are part of the ETOPS dispatch process and are not normally calculated by the flight crew. The crew normally receives ETOPS critical fuel information in the Computer Flight Plan (CFP).

Procedures

Normal procedures on ETOPS flights do not differ from standard normal procedures. However, during the last hour of ETOPS cruise, the FAA currently requires that a fuel crossfeed valve check be performed on airplanes with a single crossfeed valve. This verifies that the crossfeed valve is operating so that on the subsequent flight, if an engine fails, fuel feed is available from both main tanks through the crossfeed valve.

Before entering the ETOPS phase of flight, the APU must be operating.

ETOPS engine-out procedures may be different from standard non-normal procedures. Following an engine failure the crew performs a modified “driftdown” procedure determined by the ETOPS route requirements. This procedure typically uses higher descent and cruise speeds, and a lower cruise altitude following engine failure. This allows the airplane to reach an alternate airport within the specific time limits authorized for the operator. These cruise speeds and altitudes are determined by the airline and approved by its regulatory agency and usually differ from the engine-out speeds provided by the FMC. The captain, however, has the discretion to modify this speed if actual conditions following the diversion decision dictate such a change.

Polar Operations

Refer to the FMC Polar Navigation section in Volume 2 of the FCOM for specifics about operations in polar regions and a description of the boundaries of the polar regions.

During preflight planning extremely cold air masses should be noted and cold fuel temperatures should be considered. See the Low Fuel Temperature section in this chapter for details regarding recommendations and crew actions.

Operators should establish a remote airport diversion plan to include supporting the airplane, passengers and crew. Airplane equipment and document needs to be considered:

- cold weather clothing to enable one or more crewmembers to exit the airplane at a diversion airport with extreme cold conditions
- comprehensive instructions on securing the airplane for cold weather to include draining water tanks, etc.
- diversion airport data to include airport diagrams, information on nearby terrain and photographs (if available), emergency equipment availability, etc.
- cold temperature altitude correction table.

Due to limited availability of alternate airports relative to other regions, special attention should be given to diversion planning including airport conditions and availability of compatible fuel. Crews should be prepared to operate in QFE and metric altitude where required. Expect changes in assigned cruising levels enroute since standard cruising levels vary by FIR. Some airports provide QNH upon request, even if their standard is QFE. Metric wind speed (m/sec) may be all that is available. A simple approximation: 1 m/sec = 2 knots. A feet to meters conversion chart may be useful for planning step climbs, converting minima, etc.

Use caution when using ADF and/or VOR raw data. ADF orientation (true or magnetic) is determined by the heading reference selected by the crew. VOR radials are displayed according to the orientation of the VOR station.

Communications should be handled according to the applicable enroute charts. Above 82 degrees N, SATCOM is unavailable. HF frequencies and HF SELCAL must be arranged by the flight crew prior to the end of SATCOM coverage. Routine company communications procedures should include flight following to enable immediate assistance during a diversion or other emergency.

Note: To use SATCOM on the ground, the IRUs must be aligned.

737 NG Flight Crew Training Manual

When navigating in the polar regions, magnetic heading should be considered unreliable or totally useless for navigation. Magnetic variations typically are extreme, often are not constant at the same point and change rapidly as airplane position changes. Ensure the computer flight plan shows true tracks and true headings. Grid headings may also be used as a reference for those airplanes equipped with grid heading indicators although no airplane systems use grid heading. For some high latitude airports, grid headings are shown on the instrument approach procedures. Note that unmapped areas in the GPWS terrain data base display as magenta dots on the map, regardless of the airplane altitude.

The primary roll mode for polar operations should be LNAV, which may be used with the heading reference switch in the NORM position. HDG SEL/HOLD are functional but require the manual selection of TRUE heading reference. Deviations from planned route may be accomplished in HDG SEL.

Note: Do not use HDG SEL or ROLL CWS north of 89 degrees 30 minutes North latitude or south of 89 degrees 30 minutes South latitude, due to rapid heading and track changes occurring near either pole. At latitudes north of N85 or south of S85, the true heading on the RMI may differ from the True Heading displayed on the MAP(s), due to position differences between IRU-L and FMC.

Loss of both GPS units results in an increased ANP and possible display of the UNABLE REQD NAV PERF-RNP message but normally does not prevent continuing the polar flight.

If neither IRU is operating in the NAV mode, the airplane heading/track on the PFD and map is invalid. The GPS-L True Track on CDU PROGRESS 3/3 page provides a source of airplane track, which can be used as a secondary reference to update the heading for any IRS in ATT mode.

Descent

Descent Speed Determination

The default FMC descent speed schedule is an economy (ECON) descent from cruise altitude to the airport speed transition altitude followed by a descent at ten knots less than this speed. The speed schedule is adjusted to accommodate waypoint speed/altitude constraints displayed on the LEGS pages, and speed/altitude constraints displayed on the DES page. If desired, the ECON speed schedule can be modified by alternate Mach, Mach/IAS, or IAS values on the DES page target speed line. If the FMC information is not available, use target speeds from the Descent Rates table in this chapter.

Descent Path

An FMC path descent is the most economical descent method. At least one waypoint-related altitude constraint below cruise altitude on a LEGS page generates a descent guidance path. The path is built from the lowest constraint upward, assuming idle thrust, or approach idle below the anti-ice altitude entered on the DESCENT FORECAST page.

The path is based on the descent speed schedule, any entered speed/altitude constraints or forecast use of anti-ice. The path reflects descent wind values entered on the DESCENT FORECAST page.

Descent Constraints

Descent constraints may be automatically entered in the route when selecting an arrival procedure, or manually entered through the CDU.

Set all mandatory altitude restrictions and “at or above” constraints in the Mode Control Panel (MCP) altitude window. The next altitude may be set when the restriction has been assured or further clearance has been received.

Shallow vertical path segments may result in the autothrottle supplying partial power to maintain the target speed. Vertical path segments steeper than an idle descent may require the use of speedbrakes for speed control. Deceleration requirements below cruise altitude (such as at 10,000 MSL) are accomplished based on a rate of descent of approximately 500 fpm. When a deceleration is required at top of descent, it is performed in level flight.

Speed Intervention (As installed)

VNAV speed intervention can be used to respond to ATC speed change requirements. VNAV SPD pitch mode responds to speed intervention by changing airplane pitch while the thrust remains at idle. VNAV PTH pitch mode may require the use of speedbrakes or increased thrust to maintain the desired airspeed.

Descent Preparation Using HUD System

If the combiner was previously stowed, the combiner should be positioned and the pilot should verify that it is properly aligned with the overhead unit. For night landings, set combiner brightness high enough to ensure that the symbology is visible over bright touchdown zone lights.

Descent Planning

Flight deck workload typically increases as the airplane descends into the terminal area. Distractions must be minimized and administrative and nonessential duties completed before descent or postponed until after landing. Perform essential duties early in the descent so more time is available during the critical approach and landing phases.

Operational factors and/or terminal area requirements may not allow following the optimum descent schedule. Terminal area requirements can be incorporated into basic flight planning but ATC, weather, icing and other traffic may require adjustments to the planned descent schedule.

Proper descent planning is necessary to arrive at the desired altitude at the proper speed and configuration. The distance required for the descent is approximately 3 NM/1000 feet altitude loss for no wind conditions using ECON speed. Rate of descent is dependent upon thrust, drag, airspeed schedule and gross weight.

Descent Rates

Descent Rate tables provide typical rates of descent below 20,000 feet with idle thrust and speedbrakes extended or retracted.

Target Speed	Rate of Descent (Typical)	
	Clean	With Speedbrake
0.78M / 280 knots	2200 fpm	3100 fpm
250 knots	1700 fpm	2300 fpm
VREF 40 + 70	1100 fpm	1400 fpm

Normally, descend with idle thrust and in clean configuration (no speedbrakes). Maintain cruise altitude until the proper distance or time out for the planned descent and then hold the selected airspeed schedule during descent. Deviations from this schedule may result in arriving too high at destination and require circling to descend, or arriving too low and far out requiring extra time and fuel to reach destination.

The speedbrake may be used to correct the descent profile if arriving too high or too fast. The Descent Procedure is normally initiated before the airplane descends below the cruise altitude for arrival at destination, and should be completed by 10,000 feet MSL. The Approach Procedure is normally started at transition level.

Plan the descent to arrive at traffic pattern altitude at flaps up maneuvering speed approximately 12 miles from the runway when proceeding straight-in or about 8 miles out when making an abeam approach. A good crosscheck is to be at 10,000 feet AGL, 30 miles from the airport, at 250 knots.

Losing airspeed can be difficult and may require a level flight segment. For planning purposes, it requires approximately 25 seconds and 2 NM to decelerate from 280 to 250 knots in level flight without speedbrakes. It requires an additional 35 seconds and 3 NM to decelerate to flaps up maneuvering speed at average gross weights. Using speedbrakes to aid in deceleration reduces these times and distances by approximately 50%.

Maintaining the desired descent profile and using the map mode to maintain awareness of position ensures a more efficient operation. Maintain awareness of the destination weather and traffic conditions, and consider the requirements of a potential diversion. Review the airport approach charts and discuss the plan for the approach, landing, and taxi routing to parking. Complete the approach briefing as soon as practical, preferably before arriving at top of descent. This allows full attention to be given to airplane control.

Speedbrakes

The PF should keep a hand on the speedbrake lever when the speedbrakes are used in-flight. This helps prevent leaving the speedbrake extended when no longer required.

Use of speedbrakes between the down detent and flight detent can result in rapid roll rates and normally should be avoided. While using the speedbrakes in descent, allow sufficient altitude and airspeed margin to level off smoothly. Lower the speedbrakes before adding thrust.

Note: In flight, do not extend the speedbrake lever beyond the FLIGHT detent.

The use of speedbrakes with flaps extended should be avoided, if possible. With flaps 15 or greater, the speedbrakes should be retracted. If circumstances dictate the use of speedbrakes with flaps extended, high sink rates during the approach should be avoided. Speedbrakes should be retracted before reaching 1,000 feet AGL.

The flaps are normally not used for increasing the descent rate. Normal descents are made in the clean configuration to pattern or instrument approach altitude.

When descending with the autopilot engaged and the speedbrakes extended at speeds near VMO/MMO, the airspeed may momentarily increase to above VMO/MMO if the speedbrakes are retracted quickly. To avoid this condition, smoothly and slowly retract the speedbrakes to allow the autopilot sufficient time to adjust the pitch attitude to maintain the airspeed within limits.

When the speedbrakes are retracted during altitude capture near VMO/MMO, a momentary overspeed condition may occur. This is because the autopilot captures the selected altitude smoothly by maintaining a fixed path while the thrust is at or near idle. To avoid this condition, it may be necessary to reduce the selected speed and/or descent rate prior to altitude capture or reduce the selected speed and delay speedbrake retraction until after level off is complete.

Flaps and Landing Gear

Normal descents are made in the clean configuration to pattern or instrument approach altitude. If greater descent rates are desired, extend the speedbrakes. When thrust requirements for anti-icing result in less than normal descent rates with speedbrakes extended, or if higher than normal descent rates are required by ATC clearance, the landing gear can be lowered to increase the rate of descent.

Extend the flaps when in the terminal area and conditions require a reduction in airspeed below flaps up maneuvering speed. Normally select flaps 5 prior to the approach fix going outbound, or just before entering downwind on a visual approach.

Note: Avoid using the landing gear for increased drag. This minimizes passenger discomfort and increases gear door life.

Speed Restrictions

Speed restrictions below specific altitudes/flight levels and in the vicinity of airports are common. At high gross weights, minimum maneuvering speed may exceed these limits. Consider extending the flaps to attain a lower maneuvering speed or obtain clearance for a higher airspeed from ATC.

Other speeds may be assigned by ATC. Pilots complying with speed adjustments are expected to maintain the speed within plus or minus 10 knots.

Engine Icing During Descent

The use of anti-ice and the increased thrust required increases the descent distance. Therefore, proper descent planning is necessary to arrive at the initial approach fix at the correct altitude, speed, and configuration. The anticipated anti-ice use altitude should be entered on the DESCENT FORECAST page to assist the FMC in computing a more accurate descent profile.

Engine icing may form when not expected and may occur when there is no evidence of icing on the windshield or other parts of the airplane. Once ice starts to form, accumulation can build very rapidly. Although one bank of clouds may not cause icing, another bank, which is similar, may induce icing.

Note: The engine anti-icing system should be turned on whenever icing conditions exist or are anticipated. Failure to follow the recommended anti-ice procedures can result in engine stall, overtemperature or engine damage.

Holding

Start reducing to holding airspeed 3 minutes before arrival time at the holding fix so that the airplane crosses the fix, initially, at or below the maximum holding airspeed.

If the FMC holding speed is greater than the ICAO or FAA maximum holding speed, holding may be conducted at flaps 1, using flaps 1 maneuvering speed. Flaps 1 uses approximately 10% more fuel than flaps up. Holding speeds in the FMC provide an optimum holding speed based upon fuel burn and speed capability; but are never lower than flaps up maneuvering speed.

If holding speed is not available from the FMC, refer to the PI section of the QRH. Recommended holding speeds can be approximated by using the following guidance until more accurate speeds are obtained from the QRH:

- flaps up maneuvering speed approximates minimum fuel burn speed and may be used at low altitudes
- above FL250, use VREF 40 + 100 knots to provide adequate buffet margin.

Procedure Holding

When a procedure holding pattern is selected from the navigation data base and the FMC shows PROC HOLD on the legs page, the following is true when the PROC HOLD is the active leg:

- exiting the holding pattern is automatic; there is no need to select EXIT HOLD
- if the crew desires to remain in holding a new holding pattern must be entered.

ICAO Holding Airspeeds (Maximum)

Altitude	Speed
Through 14,000 feet	230 knots
Above 14,000 to 20,000 feet MSL	240 knots
Above 20,000 to 34,000 feet MSL	265 knots
Above 34,000 feet MSL	0.83M

FAA Holding Airspeeds (Maximum)

Altitude	Speed
Through 6,000 feet MSL	200 knots
6,001 feet MSL through 14,000 feet MSL	230 knots (210 knots Washington D. C. & New York FIRs)
14,001 feet MSL and above	265 knots

Maintain clean configuration if holding in icing conditions or in turbulence.

If the holding pattern has not been programmed in the FMC, the initial outbound leg should be flown for 1 minute or 1 1/2 minutes as required by altitude. Timing for subsequent outbound legs should be adjusted as necessary to achieve proper inbound leg timing.

In extreme wind conditions or at high holding speeds, the defined holding pattern protected airspace may be exceeded. However, the holding pattern depicted on the map display will not exceed the limits. Advise ATC if an increase in airspeed is necessary due to turbulence, if unable to accomplish any part of the holding procedure, or if unable to comply with speeds listed in the tables above.

Intentionally
Blank



Approach and Missed Approach

Chapter 5

Table of Contents

Section TOC

Preface 5.1

Approach 5.1

 Instrument Approaches 5.1

 Approach Briefing 5.2

 Approach Category 5.2

 Approach Clearance 5.3

 Procedure Turn 5.4

 Stabilized Approach Recommendations 5.4

 Mandatory Missed Approach 5.5

 Landing Minima 5.6

 Radio Altimeter (RA) 5.6

Missed Approach Point (MAP) 5.6

 Determination of a MAP 5.7

 Instrument Landing System (ILS) 5.7

 Instrument Approach using VNAV or IAN (As installed) 5.7

 Localizer 5.7

 Other Non-ILS Approaches 5.8

 Precision Approach Radar (PAR) 5.8

 Airport Surveillance Radar (ASR) 5.8

ILS Approach 5.9

 ILS Approach - Fail Passive 5.9

 ILS Approach - Fail Operational 5.10

 ILS Approach - General 5.11

 Decision Altitude/Height - DA(H) 5.11

 Alert Height - AH 5.11

 Fail Operational 5.11

Fail Passive	5.11
Procedure Turn and Initial Approach	5.12
Approach	5.12
Decision Altitude/Height - DA(H)	5.15
Raw Data - (No Flight Director)	5.15
AFDS Autoland Capabilities	5.16
Low Visibility Approaches	5.18
AFDS Faults	5.21
ILS Approach/Landing Geometry	5.24
Non-Normal Operations	5.25
Non - ILS Instrument Approaches	5.29
Non - ILS Instrument Approaches - General	5.29
Procedure Turn and Initial Approach	5.37
Vertical Path Construction	5.37
Instrument Approach Using VNAV	5.40
Instrument Approach Using IAN (As installed)	5.45
Instrument Approach Using V/S	5.50
Visual Descent Point	5.53
Missed Approach - Non-ILS	5.54
Circling Approach	5.55
Circling Approach - General	5.56
Obstruction Clearance	5.56
Circling Approach - One Engine Inoperative	5.57
Missed Approach - Circling	5.57
Visual Traffic Pattern	5.59
Visual Approach - General	5.60
Thrust	5.60
Downwind and Base Leg	5.60
Final Approach	5.61



737 NG Flight Crew Training Manual

Engine Failure On Final Approach	5.61
Touch and Go Landings	5.62
Touch and Go Landing - General	5.63
Approach	5.63
Landing	5.63
Stop and Go Landings	5.63
Go-Around and Missed Approach - All Approaches	5.65
Go-Around and Missed Approach - All Engines Operating	5.66
Go-Around after Touchdown	5.67
Go-Around and Missed Approach - One Engine Inoperative	5.68
Engine Failure During Go-Around and Missed Approach	5.68



Intentionally
Blank



Preface

This chapter outlines recommended operating practices and techniques for ILS, non-ILS, circling and visual approaches, and the Go-Around and Missed Approach maneuver. Flight profile illustrations represent the recommended basic configuration for normal and non-normal flight maneuvers and provide a basis for standardization and crew coordination.

The maneuvers are normally accomplished as illustrated. However, due to conflicting traffic at training airports, air traffic separation requirements, and radar vectors, modifications may be necessary. Conditions beyond the control of the flight crew may preclude following an illustrated maneuver exactly. The maneuver profiles are not intended to replace good judgment and logic.

Approach

Instrument Approaches

All safe instrument approaches have certain basic factors in common. These include good descent planning, careful review of the approach procedure, accurate flying, and good crew coordination. Thorough planning is the key to a safe, unhurried, professional approach.

Ensure the waypoint sequence on the LEGS page, altitude restrictions, and the map display reflect the air traffic clearance. Last minute air traffic changes or constraints may be managed by appropriate use of the MCP heading and altitude selectors. Updating the waypoint sequence on the LEGS page should be accomplished only as time permits.

Complete the approach preparations before arrival in the terminal area. Set decision altitude/height DA(H) or minimum descent altitude/height MDA(H). Crosscheck radio and pressure altimeters whenever practical. Do not completely abandon enroute navigation procedures even though air traffic is providing radar vectors to the initial or final approach fix. Check ADF/VOR selector set to the proper position. Verify ILS, VOR and ADF are tuned and identified if required for the approach.

Note: The requirement to tune and identify nav aids can be satisfied by confirming that the tuned nav aid frequency is replaced by the correct alphabetical identifier on the PFD/ND (as installed) or by aurally identifying the nav aid.

Check that the marker beacon is selected on the audio panel. The course and glide slope signals are reliable only when their warning flags are not displayed, localizer and glide slope pointers are in view, and the ILS identifier is received. Confirm the published approach inbound course is set or displayed.

Do not use radio navigation aid facilities that are out of service even though flight deck indications appear normal. Radio navigation aids that are out of service may have erroneous transmissions that are not detected by airplane receivers and no flight deck warning is provided to the crew.

Approach Briefing

Before the start of an instrument approach, the PF should brief the PM of his intentions in conducting the approach. Both pilots should review the approach procedure. All pertinent approach information, including minimums and missed approach procedures, should be reviewed and alternate courses of action considered.

As a guide, the approach briefing should include at least the following:

- weather and NOTAMS at destination and alternate, as applicable
- type of approach and the validity of the charts to be used
- navigation and communication frequencies to be used
- minimum safe sector altitudes for that airport
- approach procedure including courses and heading
- vertical profile including all minimum altitudes, crossing altitudes and approach minimums
- determination of the Missed Approach Point (MAP) and the missed approach procedure
- other related crew actions such as tuning of radios, setting of course information, or other special requirements
- taxi routing to parking
- any appropriate information related to a non-normal procedure
- management of AFDS.

Approach Category

FAA Category	Speed
C	121 knots or more but less than 141 knots
D	141 knots or more but less than 166 knots
Speed - based upon a speed of VREF in the landing configuration at maximum certificated landing weight.	

737 NG Flight Crew Training Manual

ICAO Category	Range of Speeds at Threshold	Range of Speeds for Initial Approach	Range of Speeds for Final Approach	Max Speeds for Visual Maneuvering (Circling)	Max Speeds for Missed Approach	
					Intermediate	Final
C	121/140	160/240	115/160	180	160	240
D	141/165	185/250	130/185	205	185	265

Speeds at threshold - based upon a speed of VREF in the landing configuration at maximum certified landing weight.

The designated approach category for an aircraft type is defined by the landing reference speed (VREF) at the maximum certified landing weight under both USA TERPS and ICAO PANS OPS.

- The 737 is classified as a Category “C” airplane for straight in approaches.

For circling approaches, the anticipated circling speed at the actual weight is used to determine the required approach minimums. This is because circling approach minimums for both USA TERPS and ICAO PANS OPS are based on obstruction clearance for approach maneuvering within a defined region of airspace. The region of airspace is determined as a function of actual airplane speed. This region gets larger with increasing speed, which may result in higher approach minimums depending on the terrain characteristics surrounding the airport. Similarly, approach minimums may decrease as speed is reduced for the same reason. However, the use of lower circling approach minimums based on actual approach speeds does not change the designated approach category of the airplane. Circling approach minimums are normally published as a function of maximum airplane speeds for circling in lieu of airplane approach categories on Jeppesen Approach Charts.

Approach Clearance

When cleared for an approach and on a published segment of that approach, the pilot is authorized to descend to the minimum altitude for that segment. When cleared for an approach and not on a published segment of the approach, maintain assigned altitude until crossing the initial approach fix or established on a published segment of that approach. If established in a holding pattern at the final approach fix, the pilot is authorized to descend to the procedure turn altitude when cleared for the approach.

If using a VNAV path, all altitude and speed constraints must be entered either manually, by selecting a published arrival, or by a combination of both. When properly entered, the VNAV path profile complies with all altitude constraints. Crossing altitudes may be higher than the minimum altitudes for that segment because the VNAV path is designed to optimize descent profiles.

When conducting an instrument approach from the holding pattern, continue on the same pattern as holding, extend flaps to 5 on the outbound track parallel to final approach course. Turn inbound on the procedure turn heading. This type of approach is also referred to as a race track approach.

Procedure Turn

On most approaches the procedure turn must be completed within specified limits, such as within 10 NM of the procedure turn fix or beacon. The FMC depicted procedure turn, or holding pattern in lieu of procedure turn, complies with airspace limits. The published procedure turn altitudes are normally minimum altitudes.

The FMC constructs the procedure turn path based upon predicted winds, a 170 knot airspeed and the “excursion” distance in the nav database for the procedure.

Adjust time outbound for airspeed, wind effects, and location of the procedure turn fix. If the procedure turn fix is crossed at an excessively high ground speed, the procedure turn protected airspace may be exceeded. The procedure turn should be monitored using the map to assure the airplane remains within protected airspace.

Stabilized Approach Recommendations

Maintaining a stable speed, descent rate, and vertical/lateral flight path in landing configuration is commonly referred to as the stabilized approach concept.

Any significant deviation from planned flight path, airspeed, or descent rate should be announced. The decision to execute a go-around is no indication of poor performance.

Note: Do not attempt to land from an unstable approach.

Recommended Elements of a Stabilized Approach

The following recommendations are consistent with criteria developed by the Flight Safety Foundation.

All approaches should be stabilized by 1,000 feet above airport elevation in instrument meteorological conditions (IMC) and by 500 feet above airport elevation in visual meteorological conditions (VMC). An approach is considered stabilized when all of the following criteria are met:

- the airplane is on the correct flight path
- only small changes in heading/pitch are required to maintain the correct flight path
- the airplane speed is not more than VREF + 20 knots indicated airspeed and not less than VREF
- the airplane is in the correct landing configuration
- sink rate is no greater than 1,000 fpm; if an approach requires a sink rate greater than 1,000 fpm, a special briefing should be conducted

737 NG Flight Crew Training Manual

- power setting is appropriate for the airplane configuration
- all briefings and checklists have been conducted.

Specific types of approaches are stabilized if they also fulfill the following:

- ILS approaches should be flown within one dot of the glide slope and localizer, or within the expanded localizer scale
- during a circling approach, wings should be level on final when the airplane reaches 300 feet above airport elevation.

Unique approach procedures or abnormal conditions requiring a deviation from the above elements of a stabilized approach require a special briefing.

Note: An approach that becomes unstabilized below 1,000 feet above airport elevation in IMC or below 500 feet above airport elevation in VMC requires an immediate go-around.

These conditions should be maintained throughout the rest of the approach for it to be considered a stabilized approach. If the above criteria cannot be established and maintained at and below 500 feet AFE, initiate a go-around.

At 100 feet HAT for all visual approaches, the airplane should be positioned so the flight deck is within, and tracking to remain within, the lateral confines of the runway edges extended.

As the airplane crosses the runway threshold it should be:

- stabilized on target airspeed to within + 10 knots until arresting descent rate at flare
- on a stabilized flight path using normal maneuvering
- positioned to make a normal landing in the touchdown zone (the first 3,000 feet or first third of the runway, whichever is less).

Initiate a go-around if the above criteria cannot be maintained.

Maneuvering (including runway changes and circling)

When maneuvering below 500 feet, be cautious of the following:

- descent rate change to acquire glide path
- lateral displacement from the runway centerline
- tailwind/crosswind components
- runway length available.

Mandatory Missed Approach

On all instrument approaches, where suitable visual reference has not been established and maintained, execute an immediate missed approach when:

- a navigation radio or flight instrument failure occurs which affects the ability to safely complete the approach
- the navigation instruments show significant disagreement

- on ILS final approach and either the localizer or the glide slope indicator shows full deflection
- on an RNP based approach and an alert message indicates that ANP exceeds RNP
- on an RNP based approach using a level of RNP which requires NPS and either the lateral or vertical deviation NPS pointer cannot be maintained within the ANP limits
- on a radar approach and radio communication is lost.

Landing Minima

Most regulatory agencies require visibility for landing minima. Ceilings are not required. There are limits on how far an airplane can descend without visual contact with the runway environment when making an approach. Descent limits are based on a decision altitude/height DA(H) for approaches using a glide slope or certain approaches using a VNAV path; or a MDA(H) for approaches that do not use vertical guidance, or where a DA(H) is not authorized for use. Most agencies do not require specific visual references below alert height (AH).

Approach charts use the abbreviation DA(H) or MDA(H). DA(H) applies to Category I, II, and certain fail passive Category III operations. A decision altitude “DA” or minimum descent altitude “MDA” is referenced to MSL and the parenthetical height “(H)” is referenced to Touchdown Zone Elevation (TDZE) or threshold elevation. Example: A DA(H) of 1,440’ (200’) is a DA of 1,440’ with a corresponding height above the touchdown zone of 200’.

When RVR is reported for the landing runway, it typically is used in lieu of the reported meteorological visibility.

Radio Altimeter (RA)

A radio altimeter is normally used to determine DH when a DA(H) is specified for Category II or Category III approaches, or to determine alert height (AH) for Category III approaches. Procedures at airports with irregular terrain may use a marker beacon instead of a DH to determine the missed approach point. The radio altimeter may also be used to cross check the primary altimeter over known terrain in the terminal area. However, unless specifically authorized, the radio altimeter is not used for determining MDA(H) on instrument approaches. It should also not be used for approaches where use of the radio altimeter is not authorized (RA NOT AUTHORIZED). However, if the radio altimeter is used as a safety backup, it should be discussed in the approach briefing.

Missed Approach Point (MAP)

A missed approach point is a point where a missed approach must be initiated if suitable visual references are not available to make a safe landing or the airplane is not in a position to make a safe landing.

Determination of a MAP

For approaches such as ILS or GLS, the DA(H) in conjunction with the glide slope is used to determine the MAP. For non-ILS or G/S out approaches, two methods for determining the MAP are acceptable in lieu of timing due to the accuracy of FMC positioning:

- when arriving at the MDA(H) or DA(H) in conjunction with a VNAV path
- if not using a VNAV path, use of the map display to determine when the airplane has reached the VDP or the MAP. The approach legs along with distance and time to the missed approach waypoint are displayed on the map.

Timing During Approaches

Since FMC use is appropriate for instrument approach navigation, timing is not the primary means to determine the missed approach point. The probability of multiple failures that would result in timing being the only method of determining the missed approach point is remote. However, some regulatory agencies may still require the use of timing for approaches. The timing table, when included, shows the distance from the final approach fix to the MAP.

Timing for instrument approaches is not necessary as long as there is no unable RNP alert displayed.

Instrument Landing System (ILS)

Arrival at the MAP is determined by reference to an altimeter. DA is determined by reference to the barometric altimeter, while DH is determined by reference to the radio altimeter.

Instrument Approach using VNAV or IAN (As installed)

When specifically authorized by the instrument procedure and regulatory authority, approaches may be flown to the following minima:

- a published VNAV DA(H)
- a published MDA(H) used as a decision altitude.

When either of the above minima are not specifically approved, use the published MDA(H) + 50 feet as the MAP.

Localizer

For most localizer approaches, the published MAP is the threshold of the runway. However, if a localizer approach is flown in VNAV PTH, use the missed approach criteria described in the Instrument Approach using VNAV or IAN (as installed) section in this chapter.

Other Non-ILS Approaches

The MAP for all other non-ILS approaches is depicted on the approach chart. If the procedure has a final approach fix, the MAP may be short of the runway threshold, at the runway threshold, or located over a radio facility on the field. For on airport facilities (VOR or NDB) which do not have a final approach fix, the facility itself is the MAP and in most cases is beyond the runway threshold. Do not assume the airplane will always be in a position to make a normal landing when reaching the MDA(H) before reaching the MAP. When the MAP is at or beyond the runway threshold, the airplane must reach MDA(H) before arrival at the MAP if a normal final approach is to be made.

Precision Approach Radar (PAR)

The MAP for a PAR is the geographic point where the glide path intersects the DA(H). Arrival at the MAP is determined by the pilot using the altimeter or as observed by the radar controller, whichever occurs first.

Airport Surveillance Radar (ASR)

The radar controller is required to discontinue approach guidance when the airplane is at the MAP or one mile from the runway, whichever is greater. Perform the missed approach when instructed by the controller.

ILS Approach

ILS Approach - Fail Passive

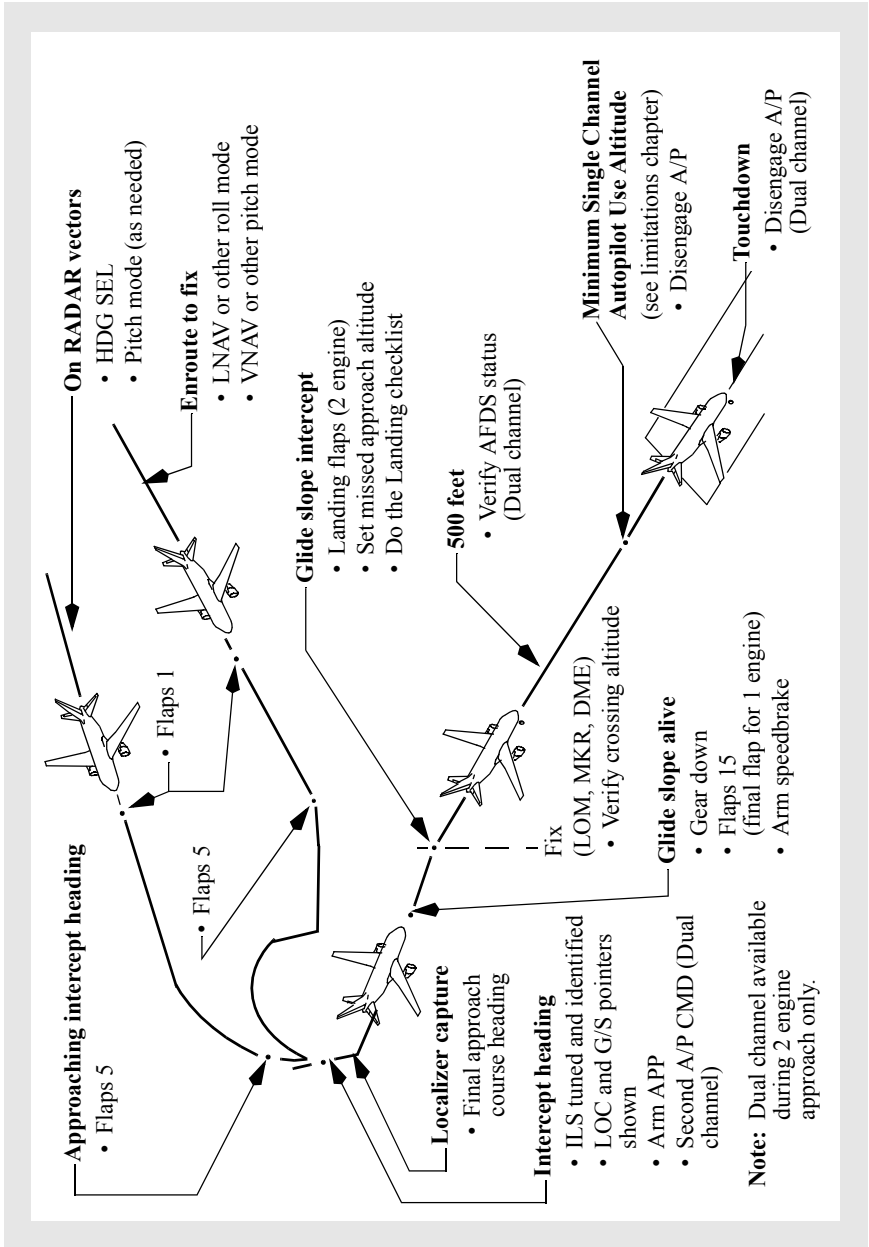

ILS Approach - Fail Operational

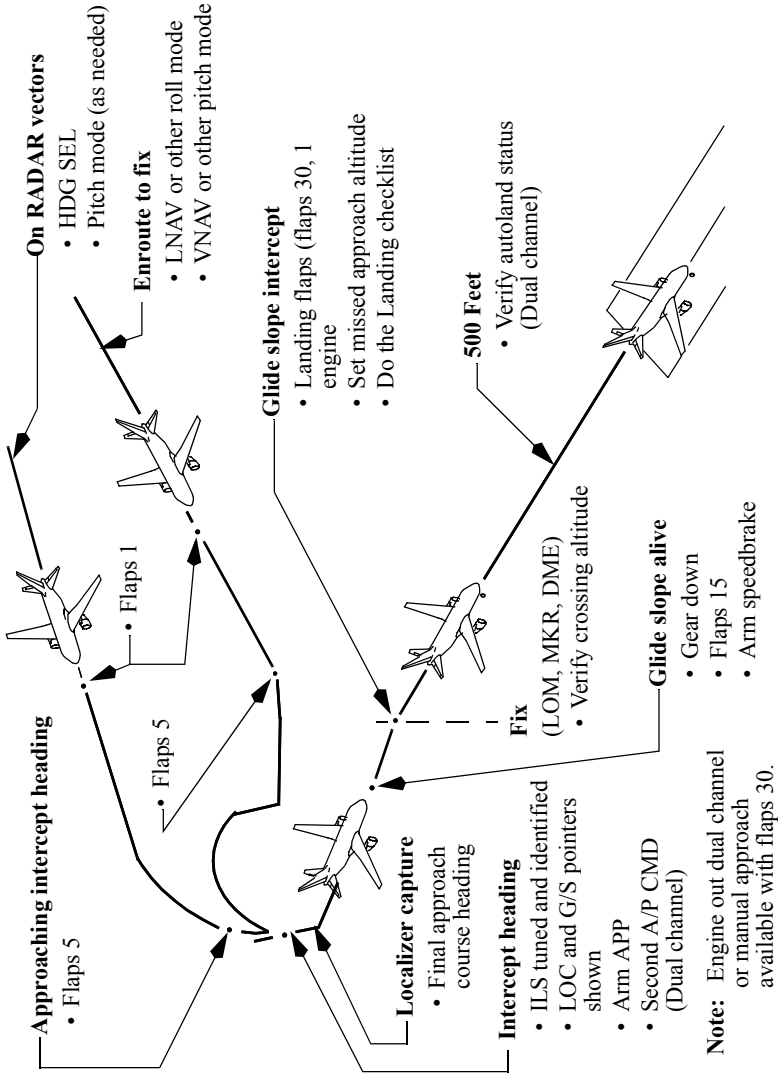

ILS Approach - General

The ILS approach illustrated assumes all preparations for the approach such as review of approach procedure and setting of minima and radios are complete. It focuses on crew actions and avionic systems information. It also includes unique considerations during low weather minima operations. The pattern may be modified to suit local traffic and air traffic requirements.

Decision Altitude/Height - DA(H)

A Decision Altitude/Height is a specified altitude or height in a precision approach where a missed approach must be initiated if the required visual reference to continue the approach has not been established. The “Altitude” value is typically measured by a barometric altimeter and is the determining factor for minima for Category I approaches, (e.g., ILS, GLS, or RNAV with VNAV). The “Height” value specified in parenthesis, typically a RA height above the touchdown zone (HAT), is advisory. The RA may not reflect actual height above terrain.

For most Category II and Category III fail passive approaches, the Decision Height is the controlling minima and the altitude value specified is advisory. A Decision Height is usually based on a specified radio altitude above the terrain on the final approach or touchdown zone.

Alert Height - AH

Alert heights are normally used for fail operational Category III operations. Alert height is a height above the runway, above which a Category III approach must be discontinued and a missed approach initiated if a specified failure occurs. For a discussion on specified failures, see the AFDS Faults section, this chapter. Radio altimeters are set in accordance with the airline's policy or at alert height to assist in monitoring autoland status. Most regulatory agencies do not require visual references below alert height.

Fail Operational

Fail operational refers to an AFDS capable of completing an ILS approach, autoland, and rollout following the failure of any single system component after passing alert height.

Fail Passive

Fail passive refers to an AFDS which in the event of a failure, causes no significant deviation of airplane flight path or attitude. A DA(H) is used as approach minimums.

Procedure Turn and Initial Approach

Cross the procedure turn fix at flaps 5 maneuvering airspeed. If a complete arrival procedure to the localizer and glide slope capture point has been selected via the CDU, the initial approach phase may be completed using LNAV and VNAV.

Approach

Both pilots should not be “heads-down” during the approach. In some cases, such as high density traffic, or when an arrival procedure is used only for reference, revising the FMS flight plan may not be appropriate.

If displaying the arrival procedure is not desired, perform a “DIRECT TO” or “INTERCEPT COURSE TO” the FAF, OM, or appropriate fix, to simplify the navigation display. This provides:

- a display of distance remaining to the FAF, OM, or appropriate fix
- a depiction of cross track error from the final approach course
- LNAV capability during the missed approach procedure.

The approach procedure may be flown using HDG SEL or LNAV for lateral tracking and VNAV, LVL CHG, or V/S for altitude changes. VNAV is the preferred descent mode when the FMS flight plan is programmed for the intended arrival. When VNAV is not available, use LVL CHG for altitude changes greater than 1,000 feet. For smaller altitude changes, V/S permits a more appropriate descent rate.

When maneuvering to intercept the localizer, decelerate and extend flaps to 5.

Attempt to be at flaps 5 and flaps 5 maneuvering speed before localizer capture.

When operating in speed intervention (as installed) or an autothrottle SPD mode, timely speed selections minimize thrust lever movement during the approach. This reduces cabin noise levels and increases fuel efficiency. When flaps are extended, select the next lower speed just as the additional configuration drag takes effect.

Delaying the speed selection causes an increase in thrust, while selecting the lower speed too quickly causes thrust to decrease, then increase.

During the approach, adjust the map display and range to provide a scaled plan view of the area. When on an intercept heading and cleared for the approach, select the APP mode and observe the VOR/LOC and G/S flight mode annunciations are armed.

APP mode should not be selected until:

- the ILS is tuned and identified
- the airplane is on an inbound intercept heading
- both localizer and glide slope pointers appear on the attitude display in the proper position
- clearance for the approach has been received.

737 NG Flight Crew Training Manual

The glide slope may be captured before the localizer in some airplanes. The glide slope may be captured from either above or below. To avoid unwanted glide slope capture, LOC mode may be selected initially, followed by the APP mode.

When using LNAV to intercept the final approach course, ensure raw data indicates localizer interception to avoid descending on the glide slope with LOC not captured. If needed, use HDG SEL to establish an intercept heading to the final approach course.

Final Approach

The pilots should monitor the quality of the approach, flare, and landing (and rollout for airplanes with automatic rollout capability) including speedbrake deployment and autobrake application.

Note: The APP mode should be selected, both autopilots engaged in CMD, and the airplane stabilized on the localizer and glide path before descending below 800 feet RA.

At localizer capture, select the heading to match the inbound course. For normal localizer intercept angles, very little overshoot occurs. Bank angles up to 30° may be commanded during the capture maneuver. For large intercept angles some overshoot can be expected.

Use the map display to maintain awareness of distance to go to the final approach fix. When the glide slope pointer begins to move (glide slope alive), extend the landing gear, select flaps 15, and decrease the speed to flaps 15 speed.

At glide slope capture, observe the flight mode annunciations for correct modes. At this time, select landing flaps and VREF + 5 knots or VREF + wind correction if landing manually, and do the Landing checklist. When using the autothrottle to touchdown, no additional wind correction is required to the final approach speed. The pilot monitoring should continue standard callouts during final approach and the pilot flying should acknowledge callouts.

When established on the glide slope, set the missed approach altitude in the altitude window of the MCP. Extension of landing flaps at speeds in excess of flaps 15 speed may cause flap load relief activation and large thrust changes.

Check for correct crossing altitude and begin timing, if required, when crossing the final approach fix (FAF or OM).

There have been incidents where airplanes have captured false glide slope signals and maintained continuous on glide slope indications as a result of an ILS ground transmitter erroneously left in the test mode. False glide slope signals can be detected by crosschecking the final approach fix crossing altitude and VNAV path information before glide slope capture. A normal pitch attitude and descent rate should also be indicated on final approach after glide slope capture. Further, if a glide slope anomaly is suspected, an abnormal altitude range-distance relationship may exist. This can be identified by crosschecking distance to the runway with altitude or crosschecking the airplane position with waypoints indicated on the navigation display. The altitude should be approximately 300 feet HAT per NM of distance to the runway for a 3° glide slope.

If a false glide slope capture is suspected, perform a missed approach if visual conditions cannot be maintained.

Below 1,500 feet radio altitude, the flare mode is armed. The FLARE annunciation indicates the second autopilot is fully engaged. As the lowest weather minimums are directly related to the system status, both pilots must observe the FLARE annunciation.

For fail operational airplanes, verify ROLLOUT is armed and LAND 3 or LAND 2 is annunciated.

Check that the A/P disengage warning light on each instrument panel is extinguished at 500 feet.

For fail operational airplanes, if an autoland annunciation changes or system fault occurs above AH that requires higher weather minimums (reversion to LAND 2 or NO AUTOLAND), do not continue the approach below these higher minimums unless suitable visual reference with the runway environment is established.

Airplanes with autopilots having fail operational capability are designed to safely continue an approach below AH after a single failure of an autopilot element. The autopilots protect against any probable system failure and safely land the airplane. AFDS design provides for an AH of at least 200 feet HAT but may be modified to a lower value by operators. The pilot should not interfere below AH unless it is clearly evident pilot action is required.

During an autoland with crosswind conditions, fail passive airplanes will touchdown in a crab. After touchdown, the rudder must be applied to maintain runway centerline. The autopilots must be disengaged immediately after touchdown. The control wheel should be turned into the wind as the autopilots are disengaged. The A/T disengages automatically two seconds after touchdown.

737 NG Flight Crew Training Manual

During an autoland with crosswind conditions, fail operational airplanes (LAND 2 or LAND 3 annunciated), the runway alignment maneuver uses forward slip to reduce the crab angle of the airplane at touchdown. Alignment begins at 450 feet radio altitude or lower, depending on the strength of the crosswind. The amount of forward slip induced is limited to 5°. When a strong crosswind is present, the airplane does not fully align with the runway, but lands with a slight crab angle. In all cases, the upwind wing is low at touchdown.

The autobrakes should remain engaged until a safe stop is assured and adequate visibility exists to control the airplane using visual references.

For fail operational airplanes, the autopilot and autobrakes should remain engaged until a safe stop is assured and adequate visibility exists to control the airplane using visual references.

Delayed Flap Approach (Noise Abatement)

If the approach is not being conducted in adverse conditions that would make it difficult to achieve a stabilized approach, the final flap selection may be delayed to conserve fuel or to accommodate speed requests by air traffic.

Intercept the glide slope with gear down and flaps 15 at flaps 15 speed. The thrust required to descend on the glide slope may be near idle. Approaching 1,000 feet AFE, select landing flaps, allow the speed to bleed off to the final approach speed, then adjust thrust to maintain it. Do the Landing checklist.

Decision Altitude/Height - DA(H)

The pilot monitoring should expand the instrument scan to include outside visual cues when approaching DA(H). Do not continue the approach below DA(H) unless the airplane is in a position from which a normal approach to the runway of intended landing can be made and suitable visual reference can be maintained. Upon arrival at DA(H), or any time thereafter, any of the above requirements are not met, immediately execute the missed approach procedure. When visual contact with the runway is established, maintain the glide path to the flare. Do not descend below the glide path.

Raw Data - (No Flight Director)

Raw data approaches are normally used during training to improve the instrument scanflow. If a raw data approach is required during normal operations, refer to the DDG or airline equivalent for the possibility of increased landing minima.

ILS deviation is displayed on the attitude display. ILS deviation may also be displayed on the navigation display by selecting an ILS mode on the EFIS Control Panel. The localizer course deviation scale on the attitude indicator remains normal scale during the approach. Continue to cross-check the map display against the attitude indicator raw data.

The magnetic course/bearing information from the VOR/ADF pointers on the navigation display may be used to supplement the attitude display localizer deviation indication during initial course interception. Begin the turn to the inbound localizer heading at the first movement of the localizer pointer.

After course intercept, the track line and read-out on the navigation display may be used to assist in applying proper drift correction and maintaining desired course. Bank as needed to keep the localizer pointer centered and the track line over the course line. This method automatically corrects for wind drift with very little reference to actual heading required.

Large bank angles are rarely required while tracking inbound on the localizer. Use 5° to 10° of bank angle.

When the glide slope pointer begins to move (glide slope alive), lower the landing gear, extend flaps 15, and decelerate to flaps 15 speed. Intercepting the glide slope, extend landing flaps and establish the final approach speed. When established on the glide slope, preset the missed approach altitude in the altitude window. On final approach, maintain VREF + 5 knots or an appropriate correction for headwind component. Check altitude crossing the FAF. Begin timing, if required. To stabilize on the final approach speed as early as possible, it is necessary to exercise precise speed control during the glide slope intercept phase of the approach. The rate of descent varies with the glide slope angle and groundspeed. Expeditious and smooth corrections should be made based on the ILS course and glide slope indications. Apply corrections at approximately the same rate and amount as the flight path deviations.

The missed approach procedure is the same as a normal missed approach. Flight Director guidance appears if TO/GA is selected. Refer to Go-Around and Missed Approach - All Approaches, this chapter.

AFDS Autoland Capabilities

Refer to the applicable AFM for a description of demonstrated autoland capabilities.

737 NG Flight Crew Training Manual

Both hydraulic systems A and B must be operational when initiating a Category III autoland approach. However, for fail operational airplanes during fail operational approaches, if a hydraulic system becomes inoperative below alert height, the automatic approach may be continued through landing and rollout. The pilot should not intervene unless it is clearly evident that pilot action is required.

Note: For autoland use flaps 30 or 40. For airplanes equipped with a fail operational autopilot using either LAND 3 or LAND 2, engine inoperative autoland may be used with flaps 30 if airplane performance permits.

Note: Autoland should not be attempted unless the final approach course path is aligned with the runway centerline. If the localizer beam is offset from the centerline the AFDS may cause the airplane to depart the runway.

ILS Performance

Most ILS installations are subject to signal interference by either surface vehicles or aircraft. To prevent this interference, ILS critical areas are established near each localizer and glide slope antenna. In the United States, vehicle and aircraft operations in these critical areas are restricted any time the weather is reported less than 800 foot ceiling and/or visibility is less than 2 miles.

Flight inspections of ILS facilities do not necessarily include ILS beam performance inside the runway threshold or along the runway unless the ILS is used for Category II or III approaches. For this reason, the ILS beam quality may vary and autolands performed from a Category I approach at these facilities should be closely monitored.

Flight crews must remember that the ILS critical areas are usually not protected when the weather is above 800 foot ceiling and/or 2 mile visibility. As a result, ILS beam bends may occur because of vehicle or aircraft interference. Sudden and unexpected flight control movements may occur at a very low altitude or during the landing and rollout when the autopilot attempts to follow the beam bends. At ILS facilities where critical areas are not protected, flight crews should be alert for this possibility and guard the flight controls (control wheel, rudder pedals and thrust levers) throughout automatic approaches and landings. Be prepared to disengage the autopilot and manually land or go-around.

For fail operational airplanes, the AFDS includes a monitor to detect significant ILS signal interference. If localizer or glide slope signal interference is detected by the monitor, the autopilot disregards erroneous ILS signals and remains engaged in an attitude stabilizing mode based on inertial data. Most ILS signal interferences last only a short period of time, in which case there is no annunciation to the flight crew other than erratic movement of the ILS raw data during the time the interference is present. No immediate crew action is required unless erratic or inappropriate autopilot activity is observed.

Autolands on Contaminated Runways - Fail Operational Airplanes

AFDS ROLLOUT mode performance cannot be assured when used on contaminated runways. The ROLLOUT mode relies on a combination of aerodynamic rudder control, nose wheel steering and main gear tracking to maintain the runway centerline using localizer signals for guidance. On a contaminated runway, nose wheel steering and main gear tracking effectiveness, and therefore airplane directional control capability, is reduced. To determine the maximum crosswind, use the most restrictive of the autoland crosswind limitation, or during low visibility approaches, the maximum crosswind authorized by the controlling regulatory agency. Consideration should also be given to the Landing Crosswind Guidelines published in chapter 6 of this manual or operator guidelines.

If an autoland is accomplished on a contaminated runway, the pilot must be prepared to disengage the autopilot and take over manually should ROLLOUT directional control become inadequate.

Low Visibility Approaches

A working knowledge of approach lighting systems and regulations as they apply to the required visual references is essential to safe and successful approaches. Touchdown RVR is normally controlling for Category I, II, and III approaches. For Category I and II approaches, mid and rollout RVR are normally advisory. For Category III operations mid and rollout RVR may be controlling. In some countries, visibility is used instead of RVR. Approval from the regulatory agency is required to use visibility rather than RVR.

During Category I approaches, visual reference requirements typically specify that either the approach lights or other aids be clearly visible to continue below DA(H). During Category I and II approaches, descent below 100 ft. above touchdown zone elevation requires the red terminating bars or red side row bars (ALSF or Calvert lighting systems, or ICAO equivalent, if installed) to be distinctly visible. If actual touchdown RVR is at or above the RVR required for the approach, the runway environment (threshold, threshold lights and markings, touchdown zone, touchdown lights and markings) should become clearly visible resulting in a successful approach. After acquiring the red terminating bars or red side row bars, if the runway environment does not become distinctly visible execute an immediate missed approach.

Category III operations using fail passive autoland systems typically reach a DH of 50 ft. when approaching the threshold. In this instance, regulations require that the runway environment be clearly visible. If not, execute an immediate missed approach.

Category III operations using fail operational autoland systems normally do not require specific visual references below AH.

737 NG Flight Crew Training Manual

A review of the approach and runway lighting systems available during the approach briefing is recommended as the pilot has only a few seconds to identify the lights required to continue the approach. For all low visibility approaches, a review of the airport diagram, expected runway exit, runway remaining lighting and expected taxi route during the approach briefing is recommended.

Regulatory agencies may require an additional 15% be added to the dry landing distance. Agencies may also require wind speed limitations less than maximum autoland wind speeds found in the FCOM.

AFDS System Configuration

The system configurations listed in this section may not include all of the systems and equipment required for each type of operation. The AFM or operating regulations may prescribe additional systems such as autobrakes, autothrottle or rain removal.

More detailed information concerning Category II and Category III operational requirements can be found in FAA advisory circulars or similar documents from other regulatory agencies.

Category II Operations

Category II approaches may be conducted using single or dual autopilots, or flight director only, with two engines. For single autopilot operation, the autopilot must be disengaged no lower than the minimum altitude listed in the Limitations Chapter of the FCOM. The autothrottles should be disconnected when the autopilot is disengaged.

Category II Approach Autopilot

The following equipment must be operative for an automatic approach requiring the use of Category II minima:

- 1 (or more) autopilots engaged
- 2 independent sources of electrical power. (The APU may be a substitute source of power for the left or right electrical system.)
- 2 ADIRU's associated with the engaged autopilot in Nav mode
- 2 attitude indicators including attitude, radio altitude, ILS deviation, DA(H) indication and AFDS status
- both engines operating
- FMA for each pilot.

Category II Approach Flight Director

The following equipment must be operative for a Flight Director (FD) approach requiring the use of Category II minima:

- 2 independent sources of electrical power. (The APU may be a substitute source of power for the left or right electrical system.)
- 2 attitude indicators supplied by different symbol generators including attitude, radio altitude, ILS deviation, DA(H) indication and AFDS status
- 2 separate flight directors, selected
- 2 ADIRU's in Nav mode
- FMA for each pilot
- both engines operating.

Category III Operations

Category III operations are typically based on an approach to touchdown using the automatic landing system. Normal operations should not require pilot intervention. However, pilot intervention should be anticipated in the event inadequate airplane performance is suspected, or when an automatic landing cannot be safely accomplished in the touchdown zone. Guard the controls on approach through landing and be prepared to take over manually, if required.

Note: For fail operational airplanes (airplanes with autopilot rollout guidance), the controls should be guarded through the landing roll.

The fail operational airplane is certified for Category IIIb operations with two engines operating for flaps 30 or 40 landing, or, when certified, with one engine operating for flaps 30 landing.

Category IIIa/Autoland

For Category IIIa operations the following equipment must be operative and FLARE arm (LAND 2 or LAND 3 for fail operational airplanes) annunciated:

- 2 independent sources of electrical power. (The APU generator may be a substitute source of power for the left or right electrical system.)
- 2 autopilots engaged
- 2 attitude indicators supplied by different display electronic units including attitude, radio altitude, ILS deviation, DA(H), and AFDS status
- 2 ADIRU's in Nav mode
- both engines operating (fail passive airplanes)
- one or two engines operating (fail operational airplanes)
- 2 hydraulic systems
- FMA for each pilot.

Category IIIb/Autoland

For Category IIIb operations, visual reference is not normally a specific requirement for continuation of the approach to touchdown.

For Category IIIb operations the following equipment must be operative and LAND 3 annunciated:

- one or two engines operating (use Cat IIIa weather minimums for one engine)
- FMA for each pilot
- autothrottle at the start of final approach
- approach minima display for each pilot
- autoland status annunciation on both pilot's displays
- antiskid operational
- normal flight controls
- windshield wipers for each pilot.

AFDS Faults

Faults can occur at any point during an AFDS approach. Many non-normal situations or scenarios are possible. The flight deck is designed so that a quick analysis and decision can be made for virtually all non-normal or fault situations using the Autopilot/Autothrottle indicators, flight mode annunciations, master caution system and, for fail operational airplanes, autoland status annunciations.

For fail operational airplanes, faults leading to non-normal operations can be divided into two categories:

- those occurring above AH
- those occurring at or below alert height.

If the flight crew is aware of the airplane equipment requirements for the approach, the following can be used for any AFDS fault indication:

Above Alert Height

Immediately after recognizing the fault from the master caution system, instrument flags, or engine indications, check autoland status annunciation.

- if the autoland status annunciation has not changed, and the equipment is not required for the approach, (e.g., flight director), continue the approach
- if the autoland status annunciation has changed, or the equipment is required for the approach, adjust to the appropriate higher minimums or go-around.

At or Below Alert Height

For any FMA alert on a fail operational airplane, continue the approach to an automatic landing and rollout unless NO AUTOLAND is displayed. The pilot should not intervene unless it is clearly evident that pilot action is required.

A thorough fault analysis was included as a part of the fail operational certification. Below 200 feet AGL a safe landing and rollout can be made with any probable failure conditions.

For fail operational airplanes, flight crew alerts (lights, or aural) may occur at any time during the approach. If a master caution or aural occurs below alert height, do not disengage the autopilot unless the autopilot system is not controlling the airplane adequately. Below alert height, the AFDS fail operational design protects against any probable system failure and will safely land the airplane. The pilot should not intervene below AH unless it is evident that pilot action is required. If a fault affects the autothrottle or autobrakes, assume manual control of thrust and braking. Accomplish related procedures for system faults after rollout is complete and manual control of the airplane is resumed.

If the autopilot is unintentionally disengaged below alert height, the landing may be completed if suitable visual reference is established. Be alert for a mistrim condition.

If a go-around is initiated with the autopilot disengaged, press the TO/GA switch. If the TO/GA switch is not pressed, the flight directors remain in the approach mode.

Dual Autopilot Approach and Go-Around Warnings - Fail Passive

WARNING	When	Cause	Pilot Response
Steady red A/P disengage warning light	Below 800' RA during approach	Stabilizer out of trim	Disengage A/P and execute manual landing (see note) or manual go-around
	During GA	Elevator position not suitable for single autopilot operation	Disengage A/P and execute manual level off OR Select higher go-around altitude
No FLARE arm annunciation	500' above field elevation during approach	Pitch and roll monitors may not be enabled, or only first A/P up is engaged	Disengage A/P and execute manual landing (see note) or manual go-around
Flashing red A/P disengage warning light and wailer	Below 800' RA during approach	A/P disengagement	Execute manual landing or manual go-around

737 NG Flight Crew Training Manual

WARNING	When	Cause	Pilot Response
Flashing red A/T disengage warning light	Anytime	A/T disengagement	Cancel A/T disengage warning and control thrust levers manually
Flashing red Autoland Warning light (as installed)	Below 500' -----or----- Below 200'	A/P disengages or stab trim warning occurs ----- ILS deviation warning occurs	Disengage autopilot and execute manual landing (see note) or manual go-around.
<p>Note: Execute manual landing only if suitable visual reference is established or if alternate landing minima can be used.</p>			



Dual Autopilot Approach and Go-Around Warnings - Fail Operational

Alert	Above 200 ft. AGL	Below 200 ft. AGL	During Rollout	During Go-Around
Flashing red A/P disengage warning light	*Execute manual go-around	**Execute manual go-around	Execute manual rollout	Execute manual go-around
Steady red A/P disengage warning light	**Disconnect and execute go-around	**Disconnect and execute go-around	N/A	Disengage autopilot and execute a manual go-around
Flashing red A/T disengage warning light	Continue with manual thrust control	Continue with manual thrust control	Continue rollout	Continue with manual thrust control
Engine failure during approach	*Execute manual go-around	Continue approach	Continue rollout	Continue go-around
NO LAND 3 or LAND 2	*Continue approach adjust minima as appropriate or go-around	N/A (inhibited)	N/A	N/A
NO AUTOLAND	*Execute go-around	N/A (inhibited)	N/A	N/A
Flashing G/S or LOC Indicators				
ILS Deviation Alert	*Execute go-around	**Execute go-around	N/A	N/A
VOR/LOC and/or G/S and A/P yellow	*Execute go-around	**Execute go-around	Execute manual rollout	Disengage autopilot and execute a manual go-around

* If suitable visual reference is not established.

** If suitable visual reference is established, land.

ILS Approach/Landing Geometry

The following diagrams use these conditions:

- data is based on typical landing weight
- airplane body attitudes are based on flaps 30, VREF 30 + 5 and should be reduced by 1° for each 5 knots above this speed

737 NG Flight Crew Training Manual

- pilot eye height measured at point when main gear crosses threshold
- airplane ILS antenna crosses threshold at 50 feet.

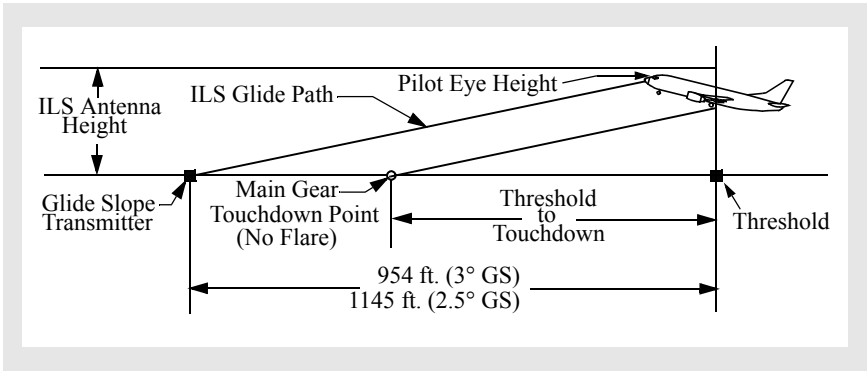

Model	Glide Path (deg)	Airplane Body Attitude (deg)	Main Gear (feet)	Pilot Eye Height (feet)	Threshold to Main Gear Touchdown Point - No Flare (feet)
737 - 600	2.5	4.1	33	49	763
	3.0	3.7	33	49	636
737 - 700	2.5	4.2	33	49	749
	3.0	3.7	33	48	624
737 - 800	2.5	2.9	33	49	753
	3.0	2.4	33	48	627
737 - 900	2.5	2.1	33	48	763
	3.0	1.6	33	48	635

Non-Normal Operations

This section describes pilot techniques associated with engine inoperative approaches. Techniques discussed minimize workload, improve crew coordination, and enhance flight safety. However, a thorough review of applicable Non-Normal Checklists associated with engine inoperative flight is a prerequisite to understanding this section.

One Engine Inoperative - Fail Passive Airplanes

AFDS management and associated procedures are similar to those used during the normal ILS approach. Flight director (manual) or single autopilot may be used.

Weather minima for an ILS approach with one engine inoperative are specified in the applicable AFM and/or the operator's Operations Specification or equivalent.

Note: The airplane is approved for flight director or single autopilot operation to Category I minimums with an engine initially inoperative if the airplane is trimmed for the condition. The use of dual autopilots with an engine inoperative is not authorized except for airplanes with a fail operational autopilot.

During a single autopilot or flight director (manual) approach, the pilot must use rudder pedal pressure to control yaw, followed by rudder trim to maintain an in-trim condition during the entire approach. A centered control wheel indicates proper trim.

Note: Use of the autothrottle for an approach with an engine inoperative is not recommended.

Minimize thrust lever movements to reduce both asymmetry and speed changes. Airplane configuration changes require little thrust change until capturing the glide slope.

Intercept the localizer with flaps 5 at flaps 5 speed. When the glide slope is alive, lower the landing gear, extend flaps to 15, set final approach speed, and decelerate.

Be prepared to take over manually in the event system performance is not satisfactory.

One Engine Inoperative - Fail Operational Airplanes

With an engine inoperative, autoland operations are authorized for flaps 30 approach only. AFDS management and associated procedures are similar to those used during the normal ILS approach. Refer to the PI chapter of the QRH for flaps 30 gear down, engine inoperative performance. If flaps 30 performance is not satisfactory, a flaps 15 engine inoperative landing is required. Autoland operations are not appropriate with flaps 15. Weather minima for an ILS approach with one engine inoperative are specified in the applicable AFM and/or the operator's Operations Specification or equivalent.

737 NG Flight Crew Training Manual

During a dual autopilot approach, the pilot must use rudder pedal pressure to control yaw, followed by rudder trim to maintain an in-trim condition until LAND 2 or LAND 3 annunciates. When LAND 2 or LAND 3 annunciates, rudder inputs are controlled by the autopilots. Directional control (yaw) is not affected by rudder trim with the autopilots in the VOR/LOC or ROLLOUT modes.

Note: Use of autopilot and autothrottle is required during the flaps 30 engine inoperative autoland approach.

Intercept the localizer with flaps 5 at flaps 5 speed. When the glide slope is alive, lower the landing gear, extend flaps to 15. At glide slope capture, select flaps 30, set VREF 30 + 5 knots.

Be prepared to take over manually in the event system performance is not satisfactory.

Additional engine-out logic is incorporated during runway alignment to ensure the downwind wing is not low at touchdown. If the crosswind is from the same side as the failed engine, then the airplane is crabbed by inducing a sideslip. This assures a 'wings-level' approach. For moderate or strong crosswinds from the opposite side of the failed engine, no sideslip is induced as the failed engine high approach configuration guarantees an upwind wing low touchdown characteristic.

Engine Inoperative, Rudder Trim - All Instrument Approaches

Rudder trim may be set to zero to facilitate directional control during thrust reduction. This should be accomplished by 500 feet AFE to allow the PM ample time to perform other duties and make appropriate altitude callouts.

Centering the rudder trim before landing allows most of the rudder pedal pressure to be removed when the thrust of the operating engine is retarded to idle at touchdown. Full rudder authority and rudder pedal steering capability are not affected by rudder trim.

It may not be advisable to center the rudder trim due to crew workload and the possibility of a missed approach. However, if touchdown occurs with the rudder still trimmed for the approach, be prepared for the higher rudder pedal forces required to track the centerline on rollout.

Engine Failure On Final Approach

737-600, 737-700

If an engine failure should occur on final approach with the flaps in the landing position, the decision to continue the approach or execute a go-around should be made immediately. If the approach is continued and sufficient thrust is available, continue the approach with landing flaps. If the approach is continued and sufficient thrust is not available for landing flaps, retract the flaps to 15 and adjust thrust on the operating engine. Speed should be increased to 15 knots over the previously set flaps 30 or 40 VREF. This is equal to at least VREF for flaps 15.

737-800, 737-900

If an engine failure should occur on final approach with the flaps in the landing position, the decision to continue the approach or execute a go-around should be made immediately. If the approach is continued and sufficient thrust is available, continue the approach with landing flaps. If the approach is continued and sufficient thrust is not available for landing flaps, retract the flaps to 15 and adjust thrust on the operating engine. Speed should be increased to 20 knots over the previously set flaps 30 or 40 VREF. This is equal to at least VREF for flaps 15.

Note: For fail operational airplanes, if an engine fails below AH, the autoland and rollout may continue.

If a go-around is required, follow the Go-Around and Missed Approach procedures except use flaps 15 initially if trailing edge flaps are at 30 or 40. Subsequent flap retraction should be made at a safe altitude and in level flight or a shallow climb.

Non - ILS Instrument Approaches

Non-ILS approaches are defined as:

- RNAV approach - an instrument approach procedure that relies on airplane area navigation equipment for navigational guidance. The FMS on Boeing airplanes is FAA-certified RNAV equipment that provides lateral and vertical guidance referenced from an FMS position. The FMS uses multiple sensors (as installed) for position updating to include GPS, DME-DME, VOR-DME, LOC-GPS, and IRS.
- GPS approach - an approach designed for use by airplanes using stand-alone GPS receivers as the primary means of navigation guidance. However, Boeing airplanes using FMS as the primary means of navigational guidance, have been approved by the FAA to fly GPS approaches provided an RNP of 0.3 or smaller is used.

Note: A manual FMC entry of 0.3 RNP is required if not automatically provided.

- VOR approach
- NDB approach
- LOC, LOC-BC, LDA, SDF, IGS, TACAN, or similar approaches.

Non-ILS approaches are normally flown using VNAV or V/S pitch modes or IAN. Recommended roll modes are provided in the applicable FCOM procedure.

Non - ILS Instrument Approaches - General

Over the past several decades there have been a number of CFIT and unstabilized approach incidents and accidents associated with non-precision (non-ILS) approaches and landings. Many of these could have been prevented by the use of constant angle approach methods. Traditional methods of flying non-ILS approaches involve setting a vertical speed on final approach, leveling off at step-down altitudes (if applicable) and at MDA(H), followed by a transition to a visual final approach segment and landing. These traditional methods involve changing the flight path at low altitudes and are not similar to methods for flying ILS approaches. Further, these traditional methods often require of the crew a higher level of skill, judgment and training than the typical ILS approach.

The following sections describe methods for flying non-ILS constant angle approaches. These methods provide a constant angle approach, which reduces exposure to crew error and CFIT accidents. These methods also make it much easier for the crew to achieve a stabilized approach to a landing once suitable visual reference to the runway environment has been established.

A typical Instrument Approach using VNAV, IAN or V/S, as illustrated, assumes all preparations for the approach; such as review of the approach procedure and setting of minima and radio tuning have been completed. The procedures illustrated focus generally on crew actions and avionics systems information. The flight pattern may be modified to suit local traffic and air traffic requirements.

The following discussions assume a straight-in instrument approach is being flown. A circling approach may be flown following an instrument approach using VNAV, IAN or V/S provided the MCP altitude is set in accordance with the circling approach procedure.

Types of Approaches

For airplanes not equipped with IAN, VNAV is the preferred method for accomplishing non-ILS approaches that have an appropriate vertical path defined on the FMC LEGS page. The section on Use of VNAV provides several methods for obtaining an appropriate path, to include published glide paths, and where necessary, a pilot constructed path. V/S may be used as an alternate method for accomplishing non-ILS approaches.

Airplanes with IAN are capable of using the MCP APP switch to fly non-ILS approaches that have an appropriate lateral and vertical path defined on the FMC LEGS page. All IAN approaches provide the functions, indications, and alerting features similar to an ILS approach while following FMC glide path. Although non-ILS approaches using LNAV and VNAV can still be executed, IAN is normally used in place of LNAV and VNAV because of improved approach displays, alerts and standardized procedures.

Use of the Autopilot during Approaches

Automatic flight is the preferred method of flying non-ILS approaches. Automatic flight minimizes flight crew workload and facilitates monitoring the procedure and flight path. During non-ILS approaches, autopilot use allows better course and vertical path tracking accuracy, reduces the probability of inadvertent deviations below path, and is therefore recommended until suitable visual reference is established on final approach.

Manually flying non-ILS approaches in IMC conditions increases workload and does not take advantage of the significant increases in efficiency and protection provided by the automatic systems. However, to maintain flight crew proficiency, pilots may elect to use the flight director without the autopilot when in VMC conditions.

Note: Currently, the VNAV PTH mode contains no path deviation alerting. For this reason, the autopilot should remain engaged until suitable visual reference has been established.

737 NG Flight Crew Training Manual
Raw Data Monitoring Requirements

During localizer-based approaches; LOC, LOC-BC, LDA, SDF, and IGS, applicable raw data must be monitored throughout the approach.

During non-localizer based approaches where the FMC is used for course or path tracking (VOR, TACAN, NDB, RNAV, GPS, etc.), monitoring raw data is recommended, if available.

During single FMC, single IRU, or single DME or single GPS operation, in the event the single operational FMC, IRU, DME, or GPS fails during the FMC approach, there must be a non-FMC means of navigation available for a missed approach such as VOR/NDB raw data and/or radar, and there must be a non-FMC approach available. Failure of the remaining single DME need not be considered if GPS updating is being used.

Checking raw data for correct navigation before commencing the approach may be accomplished by:

- pushing the POS switch on the EFIS control panel and comparing the displayed raw data with the navaid symbols on the map. Example: The VOR radials and raw DME data should overlay the VOR/DME stations shown on the MAP and the GPS position symbol should nearly coincide with the tip of the airplane symbol (FMC position)
- displaying the VOR and/or ADF pointers on the map display and using them to verify your position relative to the map display.

Typical Navigation Display

The following diagram represents a typical navigation display with the POS display selected.

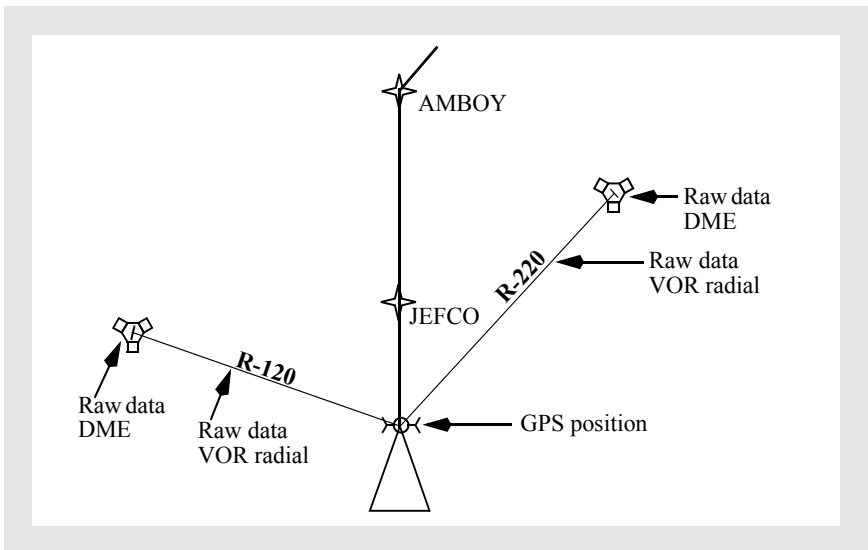

MAP Displays and Raw Data

The map mode should be used to the maximum extent practicable. The map display provides a plan view of the approach, including final approach and missed approach routing. The map increases crew awareness of progress and position during the approach.

The map is particularly useful when the inbound course does not align with runway centerline and allows the pilot to clearly determine the type of alignment maneuver required. The map can be used to integrate weather radar returns, terrain or traffic information within the approach path and airport area.

Note: When appropriate, compare airplane position on the map with ILS, VOR, DME, and ADF systems to detect possible map shift errors. Use of the POS function selectable on the EFIS control panel is the recommended method for making this comparison. The VOR and ADF pointers should be displayed on the map.

RNAV Approaches

RNAV approaches may be flown provided the RNP being used is equal to or less than the RNP specified for the approach and is consistent with the AFM demonstrated RNP capability.

Approach Requirements Relating to RNP

With appropriate operational approval, approaches requiring RNP alerting may be conducted in accordance with the following provisions:

- AFM indicates that the airplane has been demonstrated for selected RNP
- at least one GPS or one DME is operational
- any additional GPS or DME requirements specified by Operations Specification or by the selected terminal area procedure must be satisfied
- when operating with the following RNP values, or smaller:

Approach Type	RNP
NDB, NDB/DME	0.6 NM
VOR, VOR/DME	0.5 NM
RNAV	0.5 NM
GPS	0.3 NM

- no UNABLE REQD NAV PERF - RNP alert is displayed during the approach

Use of LNAV

To use LNAV for approaches and missed approaches, a proper series of legs/waypoints that describe the approach route (and missed approach) must appear on the LEGS page. There are two methods of loading these waypoints:

- **Database Selection**

This method is required for RNAV and GPS approaches. An approach procedure selected through the FMC ARRIVALS page provides the simplest method of selecting proper waypoints. Procedures in the database comply with obstruction clearance criteria for non-ILS approaches.

No waypoints may be added or deleted between the FAF and the MAP. If the approach to be flown is not in the database, another approach having the same plan view may be selected. For example, an ILS procedure might be selected if the plan view (route) is identical to an NDB approach. In this case, waypoint altitudes must be checked and modified as required. When an approach is flown by this "overlay" method, raw data should be monitored throughout the approach to assure obstacle clearance.

Note: If an NDB approach for the desired runway is in the database, an overlay approach should not be used.

If a waypoint is added to or deleted from a database procedure, FMC "on approach" logic (as described in the FCOM) is partially or completely disabled and the VNAV obstacle clearance integrity of the procedure may be adversely affected. If an additional waypoint reference is desired, use the FIX page and do not modify waypoints on the LEGS page.

- **Manual Waypoint Entry**

Due to potentially inadequate terrain clearance, manual waypoint entry should not be accomplished for RNAV or GPS approaches, nor should this method be used with VNAV after the FAF.

When no procedure is available from the FMC ARRIVALS page, manual entry of a series of waypoints may be accomplished to define the approach routing. The waypoints may be conveniently defined by using names of waypoints or nav aids in the database, bearing/distance from such fixes, intersections of radials or latitude/longitude information.

Procedure turns and DME arcs cannot usually be manually entered (unless they can be defined by a series of waypoints). Deviation from the defined route may require use of "DIRECT TO" or "INTERCEPT COURSE TO" when intercepting the inbound course. Constant monitoring of raw data during the approach is required.

Note: Procedure turns and DME arcs may require use of HDG SEL.

LNAV cannot be used to track fix or radial data displayed on the map that is not part of the active route. A navaid/waypoint and the appropriate radial may be inserted on the FIX page to create a “course” line on the map that helps to improve situational awareness. A similar display may be created by manually tuning an appropriate VOR and selecting the desired course. These methods provide reference information on the map display only. They are not reflected on the LEGS page and cannot be tracked with LNAV. These methods should only be used when there is no opportunity to use an approach selected from the navigation database and should therefore be considered only when normal means of displaying approaches are not available. Pilots should be aware that the displayed course is an FMC calculated course and is not raw data information.

Note: HDG SEL should be used to fly the approach ground track.

Note: VNAV PTH operation using speed intervention (as installed) is not available with manually entered waypoints.

If the approach is not available in the NAV database, select the landing runway from the FMC ARRIVALS page. The runway and associated extended centerline then displays on the map to aid in maintaining position awareness.

Pilots should not become involved in excessive “heads down” FMC manipulation to build map displays while at low altitude. Raw data VOR, ILS, and ADF displays should be used to avoid distractions during higher workload phases of flight. Map building should be avoided below 10,000 feet AGL.

Use of VNAV

Approaches using VNAV may be accomplished using any of the recommended roll modes provided in the FCOM procedure.

737 NG Flight Crew Training Manual

A vertical path suitable for use of VNAV is one that approximates 3° and crosses the runway threshold at approximately 50 feet. To obtain such a VNAV path, maximum use of the navigation database is recommended. For approaches where an RNP is specified, or approaches where a DA(H) is used, the waypoints in the navigation database from the FAF onward may not be modified except to add a cold temperature correction, when appropriate, to the waypoint altitude constraints. With respect to the construction of a suitable final approach path, there are two types of approaches in the navigation database:

- approaches with a glide path (GP) angle displayed on the final approach segment of the LEGS page. The final approach segment is completely compatible with VNAV and complies with final approach step down altitudes (minimum altitude constraints).
- approaches where no GP angle is published and where the approach end of the runway is defined by a runway waypoint (RWxx) or a missed approach point fix (MXxx or a named waypoint) exists. Normally these waypoints display an approximate 50 foot threshold crossing altitude constraint and may be used “as is” for VNAV. If the RWxx waypoint altitude constraint does not coincide with approximately 50 feet, this waypoint may be modified with a threshold crossing altitude of approximately 50 feet.

Note: Threshold crossing altitude normally require entry of a four-digit number. Example: enter 80 feet as 0080.

VNAV may be used for approaches modified in this way; however, the approach should be flown by constant reference to raw data (VOR, NDB, DME, etc.) and compliance with each minimum altitude constraint is required. Use of a DA(H) is not appropriate when the final approach is manually constructed in this manner.

ILS approaches coded with the appropriate threshold crossing height may be used as an overlay for other approaches such as LOC or NDB.

VNAV should be used only for approaches that have one of the following features:

- a published GP angle on the LEGS page for the final approach segment
- an RWxx waypoint coincident with the approach end of the runway
- a missed approach waypoint before the approach end of the runway, (e.g., MXxx).

These features permit construction of a normal glide path. VOR approaches with the missed approach point on the LEGS page beyond the runway threshold and circling only approaches do not have these features.

When appropriate, crews should make cold temperature altitude corrections by applying a correction from an approved table to the waypoint altitude constraints. The FMC obtains the GP angle displayed on the LEGS page from the navigation database. This GP angle is based on the standard atmosphere and is used by the FMC to calculate the VNAV path which is flown using a barometric reference. When OAT is lower than standard, true altitudes are lower than indicated altitudes. Therefore, if cold temperature altitude corrections are not made, the effective GP angle is lower than the value displayed on the LEGS page. When cold temperature altitude corrections are made, VNAV PTH operation and procedure tuning function normally; however, the airplane follows the higher of the glide path angle associated with the approach (if available) or the geometric path defined by the waypoint altitude constraints.

Note: Temperature corrections redefine the glide path only if the FMC has the geometric path option installed. Reference the applicable FCOM for optional equipment installation.

When on final approach, VNAV may be used with speed intervention active (if installed) to reduce workload. Adding speed constraints to the final approach waypoints is not recommended because of the extra workload, lack of safety benefit, and reduced ability to make last minute approach changes.

To prevent unnecessary level offs while descending in VNAV before the final approach, reset the MCP altitude selector to the next lower constraint before altitude capture, when compliance with the altitude restriction is assured.

Use of Altitude Intervention (As installed) during Approaches using VNAV

Altitude intervention is appropriate during approaches only if the AFDS enters VNAV ALT mode above the approach path and descent must be continued. Entering VNAV ALT mode can occur if passing a waypoint on the approach and the crew has failed to reset the MCP altitude to a lower altitude. If this occurs, set the MCP altitude to the next lower altitude constraint or the DA(H) or MDA(H), as appropriate, and select altitude intervention. When VNAV altitude intervention is selected, VNAV path deviation indications on the map display disappear momentarily while the path is recalculated, but should reappear.

If altitude intervention is selected when on-approach logic is active, typically after the airplane has sequenced the first approach waypoint, level flight is commanded until reaching the VNAV path, then the airplane captures the VNAV path.

Note: When a PROC HOLD is active, VNAV altitude intervention functions normally by causing the next waypoint altitude constraint to be deleted and a descent to be initiated.

Non - ILS Approach - One Engine Inoperative

Maneuvering before and after the final approach fix with one engine inoperative is the same as for an all engine non-ILS approach.

Procedure Turn and Initial Approach

Cross the procedure turn fix at flaps 5 and flaps 5 maneuvering airspeed. If a complete arrival procedure has been selected via the CDU, the initial approach phase may be completed using LNAV and VNAV path, or other appropriate modes.

Vertical Path Construction

This section describes typical final approach vertical profile (path) construction criteria as they relate to flying instrument approaches using VNAV. This information may also be useful to pilots who wish to fly the vertical path using V/S.

Where there is a glide path (GP) angle coded in the navigation database, the FMC builds the descent path upward and back in the direction of the FAF by starting at the location of the missed approach waypoint (MAP) and its associated altitude constraint. The FMC calculates this path using the coded GP angle, also called the vertical angle. The MAP is normally shown on the LEGS page as a RWxx or MXxx waypoint. In some cases a named waypoint is used as the MAP. A GP angle is coded in the navigation database for nearly all straight-in approach procedures.

This GP angle is normally defined by the state authority responsible for the approach procedure and provides a continuous descent at a constant flight path angle for a final approach path that complies with minimum altitudes at intermediate step down fixes. The typical GP angle is approximately 3.00°, but can vary from 2.75° to 3.77°.

The projection of the vertical path upward and back toward the FAF along this coded GP angle stops at the next higher limiting altitude in the vertical profile. This limiting altitude is the more restrictive of the following:

- the “At” altitude on the constrained waypoint preceding the MAP
- the first approach waypoint for the selected approach procedure.
- the crossing altitude on the next “at or above” constrained waypoint preceding the FAF

The following examples show typical VNAV final approach paths where there is a GP angle in the navigation database. The first example shows an RWxx missed approach waypoint. The second example below shows the VNAV final approach path where there is a missed approach waypoint before the runway. Note that in the second case the projected path crosses the runway threshold at approximately 50 feet. VNAV guidance is level flight, however, when the airplane passes the missed approach point. Both examples are for “At” altitude constraints at the FAF.

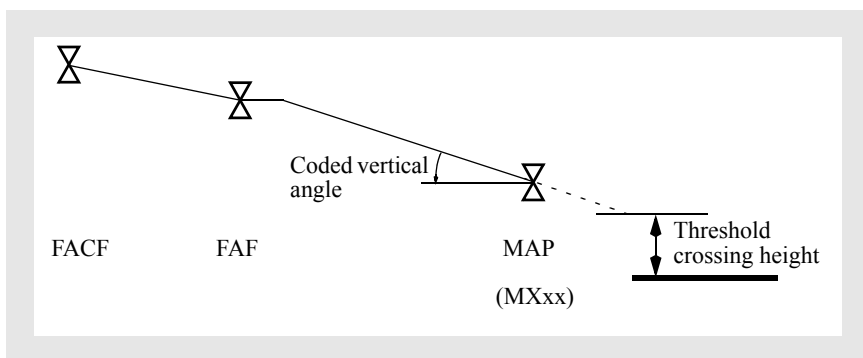
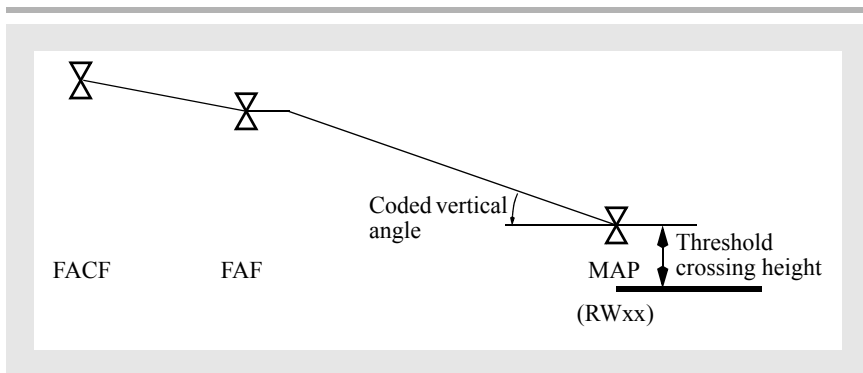

Note: The final approach course fix (FACF) is typically located on the final approach course approximately 7 NM before the FAF. The FAF referred to in the following procedures refers to the charted FAF and is intended to mean the point at which the final approach descent is begun.

For the non-ILS approach procedures with an “At” constraint altitude at the FAF, a short, level segment between the FAF and the final glide path (also called a “fly-off”) may result. For the ILS procedure, the constraint altitude at the FAF is computed to be the crossing altitude of the glide slope.

For procedures where both the FAF and FACF are coded with “at or above” altitude constraints, the crew should consider revising the FACF altitude constraint to “at” (hard constraint). This enables a shallower path before the FAF, permitting a normal deceleration for flap and gear extension. Example: In the diagram above, if both the FACF and the FAF contain “xxx/4000A” waypoint constraints, the crew should change “4000A” to “4000” at the FACF to modify the path for a more normal deceleration.

737 NG Flight Crew Training Manual

Crews can expect to see several other variations of approach path construction:

- approaches where the FAF has an “at or above” waypoint altitude constraint. The GP angle normally terminates at the FAF altitude constraint or the cruise altitude, whichever is lower. When this type of path is flown, the airplane passes above the FAF.
- where there is more than one GP angle, such as for ILS approaches, the airplane uses the GP angle for the active leg to define the VNAV approach path. These types of paths are shown on the LEGS page as having two GP angle values, one approaching the FAF, the second approaching the runway (missed approach point).

Note: The coded GP angle is steeper than normal in temperatures warmer than ISA standard and is shallower than normal in temperatures colder than ISA standard.

Instrument Approach Using VNAV

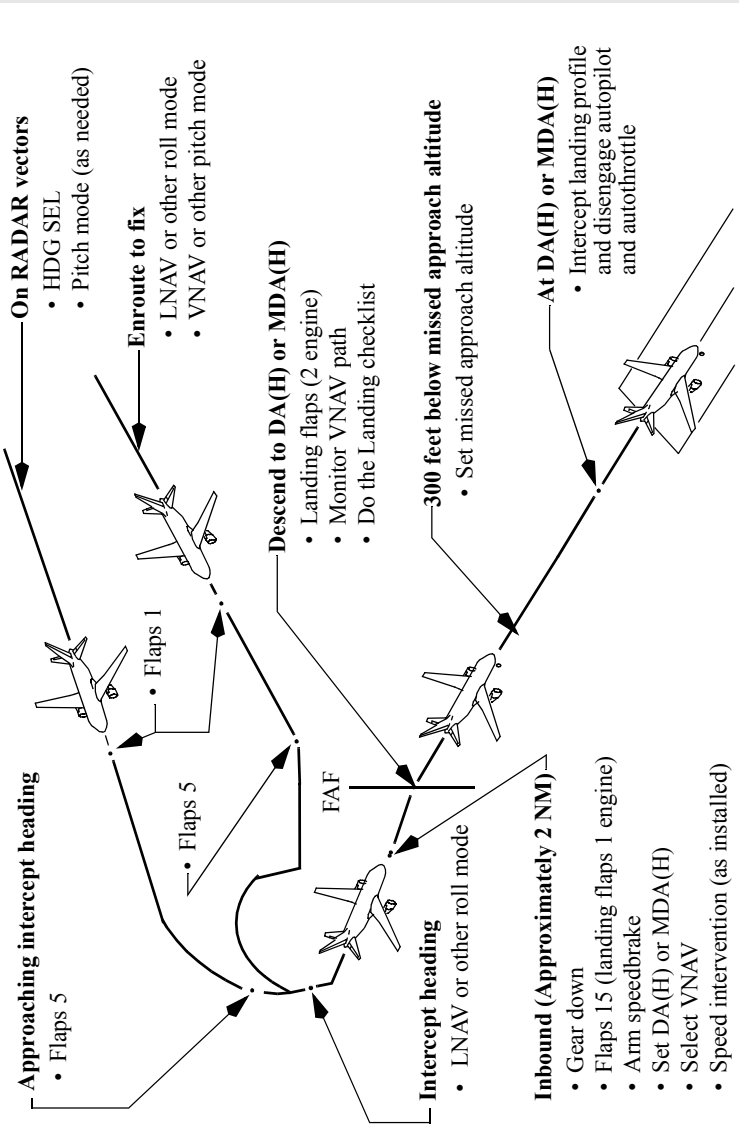

737 NG Flight Crew Training Manual

Approach Preparations for using VNAV

Select the approach procedure from the ARRIVALS page of the FMC. Tune and identify appropriate navaids. Do not manually build the approach or add waypoints to the procedure. If additional waypoint references are desired, use the FIX page. To enable proper LNAV waypoint sequencing, select a straight-in intercept course to the FAF when being radar vectored to final approach.

Verify/enter the appropriate RNP and set the DA(H) or MDA(H) using the baro minimums selector. If required to use MDA(H) for the approach minimum altitude, the barometric minimums selector should be set at MDA + 50 feet to ensure that if a missed approach is initiated, descent below the MDA(H) does not occur during the missed approach.

Note: The approach RNP is not displayed until 2 NM before the first waypoint of the approach, including approach transitions, or when below 2,000 feet above the airport, whichever occurs first unless the pilot manually enters an RNP or the navigation data base specifies the RNP value.

Enter the appropriate wind correction on the APPROACH REF page or use speed intervention, if available.

Transition to an Instrument Approach using VNAV

There are several techniques which help ensure a smooth descent transition to a non-ILS final approach where VNAV PTH will be used.

Note: The FAF is normally the waypoint shown on the LEGS page and map display just before the final approach segment. The following discussions assume the FAF altitude constraint is set in the MCP while descending toward the FAF.

If descending to FAF altitude in LVL CHG or V/S, or if in ALT HOLD at the FAF altitude, set DA(H)/MDA(H) in the MCP and engage VNAV when approximately 2 NM before the FAF. Speed intervention (as installed) may also be engaged, if desired. The airplane will descend on final approach in VNAV PTH.

If descending in VNAV PTH before final approach and the situation permits a continuous descent through final approach, remain in VNAV PTH while configuring the airplane for approach and landing. The airplane will slow automatically to the maneuver speed for the current flap setting. Reset the MCP to DA(H)/MDA(H) approximately 2 NM before the FAF (waypoint just before the final approach segment) to prevent level off. Speed intervention (as installed) may also be engaged, if desired.

If descending in VNAV SPD, the AFDS will change to VNAV PTH automatically when approaching the FAF if the airplane is on or below the path. Reset the MCP to the DA(H)/MDA(H) approximately 2 NM before the FAF. If the AFDS enters ALT HOLD mode beyond the FAF, set DA(H)/MDA(H) in the MCP and select VNAV without delay. If VNAV ALT (as installed) has engaged beyond the FAF, set DA(H)/MDA(H) in the MCP and select altitude intervention without delay to enable continued descent on the final approach path. Execute a missed approach if the deviation above path becomes excessive enough to prevent achieving a stabilized approach.

Final Approach using VNAV

Approaching intercept heading, select flaps 5 and select LNAV or other appropriate roll mode. Approaching the FAF (approximately 2 NM), select gear down and flaps 15. Adjust speed if using speed intervention. Set the DA(H) or MDA(H) in the MCP altitude window, select VNAV, and ensure VNAV PTH and appropriate roll mode is annunciated.

Note: If desired altitude is not at an even 100 foot increment, set the MCP altitude to the nearest 100 ft. increment above the altitude constraint or MDA(H).

Just before the FAF, select landing flaps, slow to final approach speed and do the Landing checklist. If the charted FAF is too close to the runway to permit a stabilized approach, consider establishing final approach pitch mode and configuring for approach and landing earlier than specified in the FCOM procedure.

With the MCP altitude set to DA(H) or MDA(H) and the airplane stabilized on the final approach path, the map altitude range arc assists in determining the visual descent point (VDP). As soon as the airplane is at least 300 feet below the missed approach altitude and stabilized on final approach in VNAV PTH, set the MCP altitude to the missed approach altitude. VNAV path deviation indications on the map display assist in monitoring the vertical profile. The autopilot tracks the path in VNAV PTH resulting in arrival at, or near, the visual descent point by the DA(H) or MDA(H).

Minimum Descent Altitude (MDA(H))/Decision Altitude (DA(H))

When specifically authorized by the instrument procedure and regulatory authority, approaches may be flown to the following minima:

- a published VNAV DA(H)
- a published MDA(H) used as a decision altitude

When either of the above minima are not specifically authorized, use the MDA(H) specified for the instrument procedure.

The following diagram illustrates an approach procedure containing DA(H) and MDA(H) minimums for approaches using LNAV/VNAV or LNAV only.

737 NG Flight Crew Training Manual

STRAIGHT-IN LANDING RWY 28R					CIRCLE - TO - LAND		
LNAV/VNAV DA(H) 740' (727')			LNAV MDA(H) 1000' (987')		Max Kts	MDA(H)	
ALS out		ALS out					
A	2	2 1/2	RVR 40 or 3/4	RVR 60 or 1 1/4	90	1000' (987') -2	
B			RVR 50 or 1	1 1/2	120		
C			2 1/2	3	140		1140' (1027') -3
D					2 1/4		165

Note: Some non-ILS approaches specify a VNAV DA(H). Regulations may require use of the autopilot in the VNAV PTH mode to permit use of the DA(H).

When reaching the DA(H) or MDA(H), be prepared to disengage the autopilot, disconnect the autothrottle and land or execute an immediate go-around.

Note: If using an MDA(H), initiating a missed approach approximately 50 feet above MDA(H) may be necessary to avoid descending below the MDA(H) during the missed approach, if required for the procedure or by the regulatory authority.

The pilot monitoring should expand the instrument scan to include outside visual cues when approaching DA(H) or MDA(H). Do not continue the approach below DA(H) or MDA(H) unless the airplane is in a position from which a normal approach to the runway of intended landing can be made and suitable visual reference can be maintained. Upon arrival at DA(H) or MDA(H) or any time thereafter, if any of the above requirements are not met, immediately execute the missed approach procedure.

When suitable visual reference is established, maintain the descent path to the flare. Do not descend below the visual glide path. While VNAV PTH guidance may still be used as a reference once the airplane is below DA(H) or MDA(H), the primary means of approach guidance is visual.

Note: VNAV path guidance transitions to level flight once the missed approach fix is passed.

Simulated Instrument Approach Using VNAV

To maintain proficiency, crews may practice instrument approach using VNAV procedures while flying ILS approaches as follows:

- ensure the ILS is tuned and identified and the ILS raw data is monitored throughout the approach
- track the localizer using VOR/LOC or LNAV as the roll mode

- use VNAV as the pitch mode to track the GP angle. The charted GP angle normally coincides with the ILS glide slope angle
- disengage the autopilot by the minimum altitude specified in the Limitations chapter of the FCOM.

Note: Limit the use of the above technique to VMC weather conditions.

In ambient temperature conditions warmer than ISA standard, the airplane may remain slightly high relative to the ILS glide slope, and in temperatures colder than ISA standard, the airplane may remain slightly lower than the ILS glide slope. Discontinue use of this technique and manually track the localizer and glide slope if localizer or glide slope deviations become unacceptable.

Instrument Approach Using IAN (As installed)

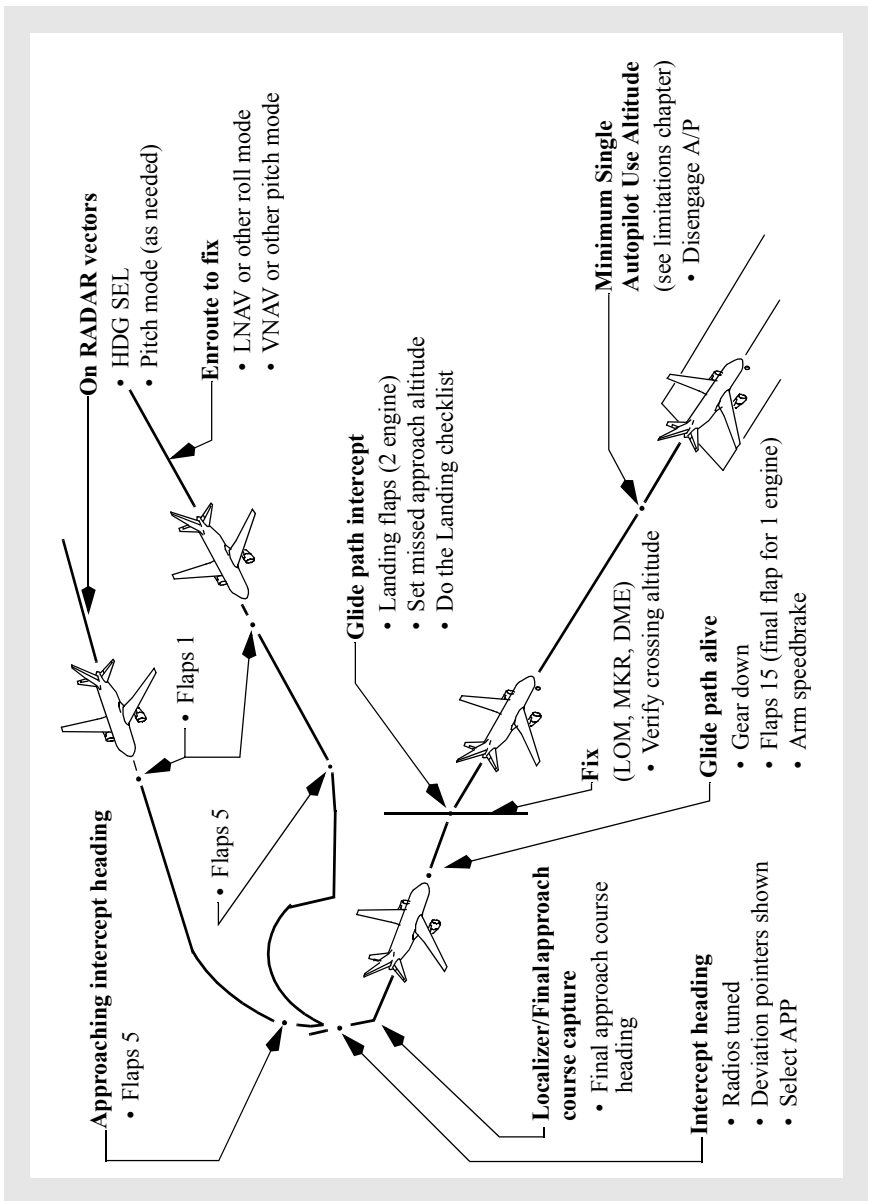

Use of IAN - General

The approach profile illustrated depicts crew actions used during an approach using Integrated Approach Navigation (IAN). Since IAN approach techniques are similar to ILS approach techniques, only items considered unique to IAN are discussed in the remainder of this section. The approach profile illustrated assumes all preparations for the approach such as review of the approach procedure and setting of minima and radios, as required, are complete.

Airplanes with IAN are capable of using the MCP APP switch to execute instrument approaches based on flight path guidance from the navigation radios, the FMC, or a combination of both. All IAN approaches provide the functions, indications and alerting features similar to an ILS approach. Although non-ILS approaches using LNAV and VNAV can still be performed, IAN is normally used in place of LNAV and VNAV because of improved approach displays, alerts and standardized procedures.

IAN approach types:

- RNAV
- GPS
- VOR approach
- NDB approach
- LOC, LOC-BC, LDA, SDF, TACAN, or similar approaches.

Note: IAN annunciations are not displayed on the HUD, standby ADI, or ISFD.

IAN Requirements and Restrictions

- airplanes must be equipped with FMC U10.5 or later and IAN FMA displays
- dual or single engine approaches are authorized
- raw data monitoring is required during localizer based approaches. During FMC based non-ILS approaches, raw data monitoring is recommended when available in accordance with the techniques described in the Non-ILS approach section in this chapter
- QFE operation is not authorized
- RNP appropriate for the approach must be used
- the autopilot is required until suitable visual reference is established when performing an approach requiring an RNP of 0.15 or lower.

Flight Mode Annunciations and other IAN Features

FMAs vary depending on the source of the navigation guidance used for the approach, navigation radio or FMC.

For localizer based approaches:

737 NG Flight Crew Training Manual

Approach	FMA
ILS with G/S out, LOC, LDA, SDF	VOR/LOC and G/P
B/C LOC	BCRS and G/P

If the FMC is used for lateral (course) guidance:

Approach	FMA
GPS, RNAV	FAC and G/P
VOR, NDB, TACAN	FAC and G/P

Approach Preparations for using IAN

IAN may be used with the flight director, single autopilot, or flown with raw data. The procedure turn, initial approach, and final approach are similar to the ILS.

For FMC based approaches, a proper series of legs/waypoints describing the approach route including an appropriate vertical path or glide path (GP) angle must appear on the LEGS page. A GP angle displayed on the LEGS page means the vertical path complies with final approach step down altitudes (minimum altitude constraints). A glide path angle suitable for an IAN approach is one that approximates 3° and crosses the runway threshold at approximately 50 feet. Waypoints in the navigation database from the FAF onward may not be modified. Cold temperature altitude corrections are not permitted when using IAN.

The appropriate procedure must be selected in the FMC. If final approach course guidance is derived from the localizer, the radios must be tuned to the appropriate frequency. If final approach course guidance is derived from the FMC, radios must be tuned to a VOR frequency.

Note: For all approaches, including B/C LOC approaches, the inbound front course must be set in the MCP.

Final Approach using IAN

When cleared for the approach, select the approach mode. Before engagement of the approach mode, grey lateral and vertical deviation pointers are displayed in addition to the deviation pointers for engaged modes. These pointers show the pilot the direction of the final approach course and glide path relative to the airplane. As course and glide path capture occurs, the appropriate pointers turn magenta.

Deviation scales are proportional to RNP. Similar to ILS localizer and glide slope deviation scales, the IAN deviation scales become more sensitive as the airplane approaches the runway.

GPWS glide slope alerting is provided on IAN airplanes during ILS and IAN approaches. The GPWS glide slope alerting provides alerting when the airplane deviates below the glide slope (ILS) or glide path (IAN) before reaching a full scale deflection. During the approach, any time a full scale vertical or lateral deflection occurs or an UNABLE REQ'D NAV - RNP alert occurs and suitable visual reference has not been established, a missed approach must be executed.

The final approach is similar to the ILS final approach, however the IAN mode does not support dual autopilot coupled approaches. Therefore, the autopilot should be disconnected no lower than the minimum single autopilot use altitude specified in the Limitations chapter of the FCOM. Set missed approach altitude after glide path capture.

If the final approach course is offset from the runway centerline, maneuvering to align with the runway centerline is required. When suitable visual reference is established, the airplane should continue following the glide path (GP) angle while maneuvering to align with the runway.

With the autopilot engaged below 100 feet radio altitude, an aural GPWS alert sounds and the autopilot engage status flashes to remind the crew that the autopilot must be disengaged before landing.

Minimum Descent Altitude (MDA(H))/Decision Altitude (DA(H))

When specifically authorized by the instrument procedure and regulatory authority, approaches may be flown to the following minima:

- a published VNAV DA(H)
- a published MDA(H) used as a decision altitude

When either of the above minima are not specifically authorized, use the MDA(H) specified for the instrument procedure.

When reaching the DA(H) or MDA(H), be prepared to disengage the autopilot, disconnect the autothrottle and land or execute an immediate go-around.

Note: If using an MDA(H), initiating a missed approach approximately 50 feet above MDA(H) may be necessary to avoid descending below the MDA(H) during the missed approach, if required for the procedure or by the regulatory authority.

The pilot monitoring should expand the instrument scan to include outside visual cues when approaching DA(H) or MDA(H). Do not continue the approach below DA(H) or MDA(H) unless the airplane is in a position from which a normal approach to the runway of intended landing can be made and suitable visual reference can be maintained. Upon arrival at DA(H) or MDA(H) or any time thereafter, if any of the above requirements are not met, immediately execute the missed approach procedure.

737 NG Flight Crew Training Manual

When suitable visual reference is established, maintain the descent path to the flare. Do not descend below the visual glide path. While VNAV PTH guidance may still be used as a reference once the airplane is below DA(H) or MDA(H), the primary means of approach guidance is visual.

Note: Glide path guidance transitions to level flight once the missed approach fix is passed.

Instrument Approach Using V/S

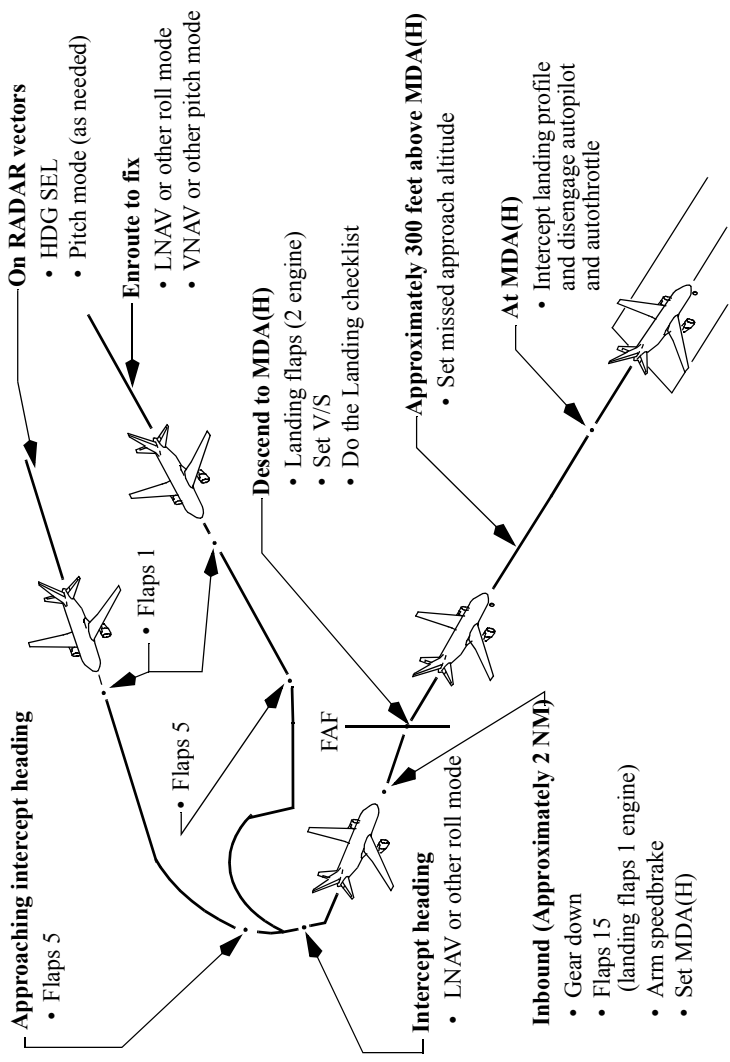

Approach Preparations for using V/S

Select the approach procedure from the ARRIVALS page of the FMC. Tune and identify appropriate nav aids. If additional waypoint references are desired, use the FIX page. To enable proper LNAV waypoint sequencing, select a straight-in intercept course to the FAF when being radar vectored to final approach.

Verify/enter the appropriate RNP and set the MDA(H) using the baro minimums selector. If required to use MDA(H) for the approach minimum altitude, the barometric minimums selector should be set at MDA + 50 feet to ensure that if a missed approach is initiated, descent below the MDA(H) does not occur during the missed approach.

Final Approach using V/S

Approaching intercept heading, select flaps 5 and select LNAV or other appropriate roll mode. Approaching the FAF (approximately 2 NM), select gear down and flaps 15 and adjust speed. Set the MCP altitude window to the first intermediate altitude constraint, or MDA(H) if no altitude constraint exists.

Note: If desired altitude is not at an even 100 foot increment, set the MCP altitude to the nearest 100 ft. increment above the altitude constraint or MDA(H).

Just before FAF, select landing flaps, slow to final approach speed and do the Landing checklist. If the charted FAF is too close to the runway to permit a stabilized approach, consider establishing final approach pitch mode and configuring for approach and landing earlier than specified in the FCOM procedure.

At or after the FAF, select V/S mode and descend at appropriate vertical speed to arrive at the MDA(H) at a distance from the runway (VDP) to allow a normal landing profile. Initial selection of an appropriate V/S should be made considering the recommended vertical speeds that are published on the approach chart, if available. These recommended vertical speeds vary with the airplane's ground speed on final approach. If no recommended vertical speeds are available, set approximately -700 to -800 fpm.

When stabilized in a descent on final approach, use one of the following techniques to make small incremental changes to the resulting vertical speed to achieve a constant angle descent to minimums. There should be no level flight segment at minimums.

Several techniques may be used to achieve a constant angle path that arrives at MDA(H) at or near the VDP:

- the most accurate technique is to monitor the VNAV path deviation indication on the map display and adjust descent rate to maintain the airplane on the appropriate path. This technique requires the path to be defined appropriately on the LEGS page and that the header GPx.xx is displayed for the missed approach point or there is a RWxx, Mxxx, or named waypoint on the legs page with an altitude constraint which corresponds to approximately 50 ft. threshold crossing height. When this method is used, crews must ensure compliance with each minimum altitude constraint on the final approach segment (step down fixes).
- select a descent rate that places the altitude range arc at or near the stepdown fix or visual descent point (VDP). This technique requires the stepdown fix or MDA(H) to be set in the MCP and may be difficult to use in turbulent conditions. See the Visual Descent Point section for more details on determining the VDP.
- using 300 feet per mile for a 3° path, determine the desired HAA which corresponds to the distance in NM from the runway end. The PM can then call out recommended altitudes as the distance to the runway changes (Example: 900 feet - 3 NM, 600 feet - 2NM, etc.). The descent rate should be adjusted in small increments for significant deviations from the nominal path.

Be prepared to land or go-around from the MDA(H) at the VDP. Note that a normal landing cannot be completed from the published missed approach point on many instrument approaches.

Approximately 300 feet above the MDA(H), select the missed approach altitude. Leaving the MDA(H), disengage the autopilot and disconnect the autothrottle. Turn both F/Ds OFF, then place both F/Ds ON. This eliminates unwanted commands for both pilots and allows F/D guidance in the event of a go-around. Complete the landing.

Minimum Descent Altitude/Height (MDA(H))

The pilot monitoring should expand the instrument scan to include outside visual cues when approaching MDA(H). Do not continue the approach below MDA(H) unless the airplane is in a position from which a normal approach to the runway of intended landing can be made and suitable visual reference can be maintained. Upon arrival at MDA(H) or any time thereafter, if any of the above requirements are not met, immediately execute the missed approach procedure.

When suitable visual reference is established, maintain the descent path to the flare. Do not descend below the visual glide path.

Visual Descent Point

For a non-ILS approach, the VDP is defined as the position on final approach from which a normal descent from the MDA(H) to the runway touchdown point may be initiated when suitable visual reference is established. If the airplane arrives at the VDP, a stabilized visual segment is much easier to achieve since little or no flight path adjustment is required to continue to a normal touchdown.

VDPs are indicated on some non-ILS approach charts by a "V" symbol. The distance to the runway is shown below the "V" symbol. If no VDP is given, the crew can determine the point where to begin the visual descent by determining the height above the airport (HAA) of the MDA(H) and use 300 feet per NM distance to the runway.

In the following example, an MDA(H) of 550 feet MSL with a 100 feet touchdown zone elevation results in a HAA of 450 feet. At 300 feet per NM, the point to begin the visual descent is 1 ½ NM distance from the runway.

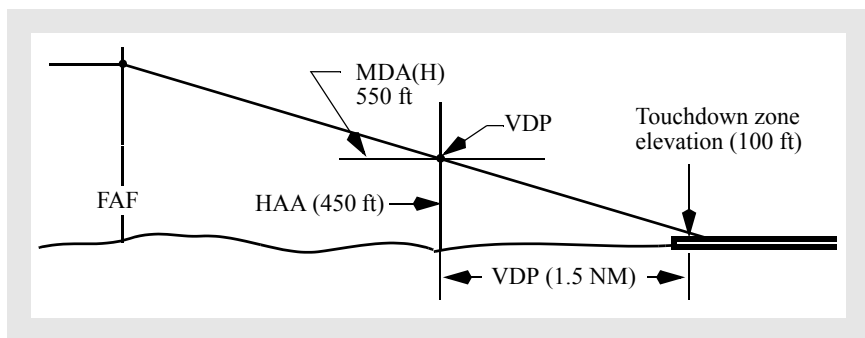

Most VDPs are between 1 and 2 NM from the runway. The following table provides more examples.

HAA (feet)	300	400	450	500	600	700
VDP Distance, NM	1.0	1.3	1.5	1.7	2.0	2.3

Note: If flying a VNAV path approach and the airplane remains on the published path, then the VDP is automatically complied with when the airplane arrives at the DA(H) or MDA(H). It is not necessary to determine the point to begin the visual descent for VNAV path approaches for this reason.

When flying an instrument approach using V/S, if the pilot adjusts the altitude range arc to approximately the VDP distance in front of the runway by varying the vertical speed, the airplane will remain close to or on the proper path for typical non-ILS approaches.



Missed Approach - Non-ILS

Refer to Go-Around and Missed Approach - All Approaches, this chapter.

Circling Approach

If a missed approach is needed at any time while circling, make an initial climbing turn toward the landing runway and intercept the missed approach course.

Configuration at MDA(H)

- Gear down
- Gear up (1 engine)
- Flaps 15
- Flaps 10 (1 engine)
- Arm speedbrake

Before turning base or initiating the turn to base

- Gear down (1 engine)
- Landing flaps
- Do the Landing checklist

MCP altitude / MDA(H)

- Select ALT HOLD (as needed)
- Set missed approach altitude
- Select HDG SEL

Intercepting landing profile

- Disengage autopilot and autothrottle

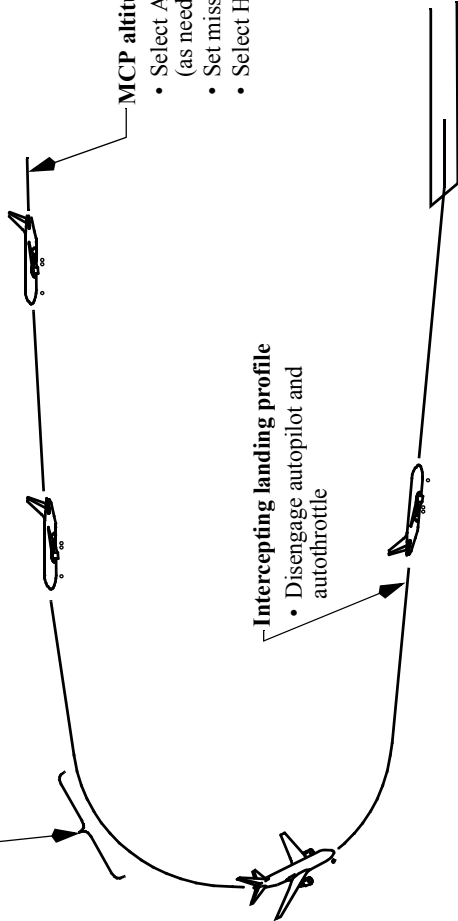

Circling Approach - General

The circling approach should be flown with landing gear down, flaps 15, and at flaps 15 maneuvering speed. Use the weather minima associated with the anticipated circling speed. Maintain MCP altitude or MDA(H) using ALT HOLD mode and use HDG SEL for the maneuvering portion of the circling approach. If circling from an ILS approach, fly the ILS in VOR/LOC and VNAV or V/S modes.

Note: If the MDA(H) does not end in “00”, set the MCP altitude to the nearest 100 feet above the MDA(H) and circle at MCP altitude.

Use of the APP mode for descent to a circling approach is not recommended for several reasons:

- the AFDS does not level off at MCP altitude
- exiting the APP mode requires initiating a go-around or disconnecting the autopilot and turning off the flight directors.

Note: If VNAV ALT (as installed) is allowed to remain as the pitch mode during the circling maneuver with a higher altitude, (e.g., missed approach altitude), set in the MCP, the VNAV ALT pitch mode will revert to CWS P.

When in altitude hold at MCP altitude or MDA(H) and before commencing the circling maneuver, set the missed approach altitude.

Before turning base or when initiating the turn to base leg, select landing flaps and begin decelerating to the approach speed plus wind correction. To avoid overshooting final approach course, adjust the turn to final to initially aim at the inside edge of the runway threshold. Timely speed reduction also reduces turning radius to the runway. Do the Landing checklist. Do not descend below MDA(H) until intercepting the visual profile to the landing runway.

Leaving MDA(H), disengage the autopilot and autothrottle. After intercepting the visual profile, cycle both F/D to OFF, then to ON. This eliminates unwanted commands for both pilots and allows F/D guidance in the event of a go-around. Complete the landing.

Note: If a go-around is selected with either flight director switch in the OFF position, the flight director pitch or roll command bar on the corresponding side will disappear when the first pitch or roll mode is selected or engaged.

Obstruction Clearance

Obstruction clearance areas during the circling approach are depicted in the following figure. Distances are determined by aircraft approach category. Adjust airplane heading and timing so that the airplane ground track does not exceed the obstruction clearance distance from the runway at any time during the circling approach.

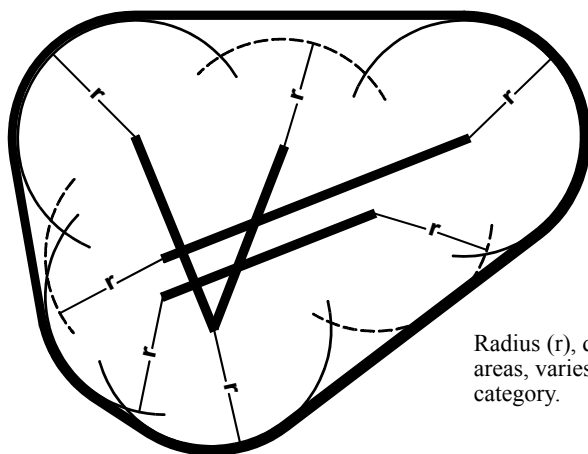

Radius (r), defining size of areas, varies with airplane category.

Aircraft Category	FAA Obstruction Clearance Radius (r)	ICAO Obstruction Clearance Radius (r)
C	1.7 NM	4.2 NM
D	2.3 NM	5.28 NM

Circling Approach - One Engine Inoperative

If a circling approach is anticipated, maintain gear up, flaps 10, and flaps 10 maneuvering speed from the final approach fix until just before turning base. As an option, use flaps 5, and flaps 5 maneuvering speed as the approach flaps setting for the circling approach. Before turning base or when initiating the turn to base leg, select gear down and flaps 15 and begin reducing speed to VREF 15 + wind correction. Do not descend below MDA(H) until intercepting the visual profile.

Missed Approach - Circling

If a missed approach is required at any time while circling, make a climbing turn in the shortest direction toward the landing runway. This may result in a turn greater than 180° to intercept the missed approach course. Continue the turn until established on an intercept heading to the missed approach course corresponding to the instrument approach procedure just flown. Maintain the missed approach flap setting until close-in maneuvering is completed.

Different patterns may be required to become established on the prescribed missed approach course. This depends on airplane position at the time the missed approach is started. The following figure illustrates the maneuvering that may be required. This ensures the airplane remains within the circling and missed approach obstruction clearance areas.

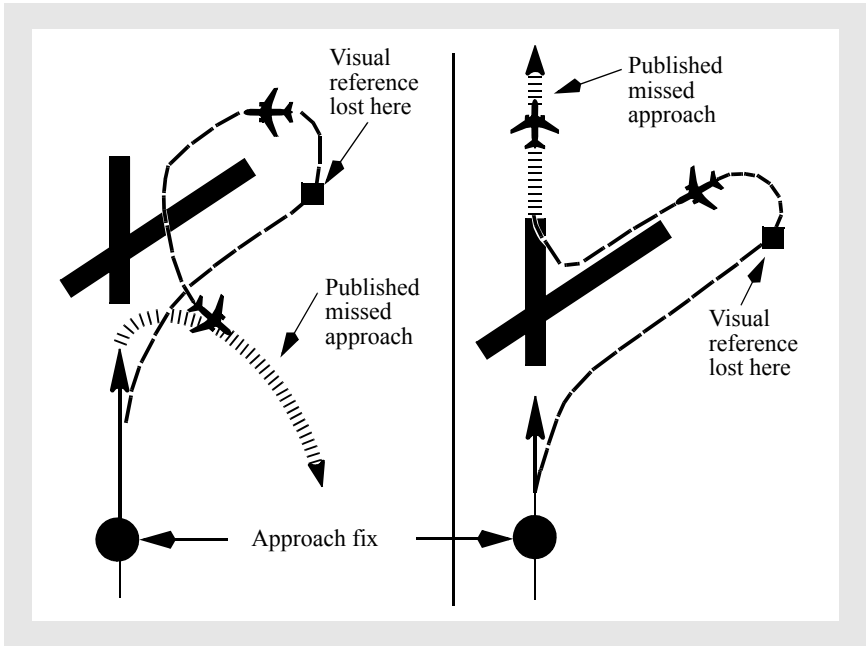

In the event that a missed approach must be accomplished from below the MDA(H), consideration should be given to selecting a flight path which assures safe obstacle clearance until reaching an appropriate altitude on the specified missed approach path.

Refer to Go-Around and Missed Approach - All Approaches, this chapter.

Visual Traffic Pattern

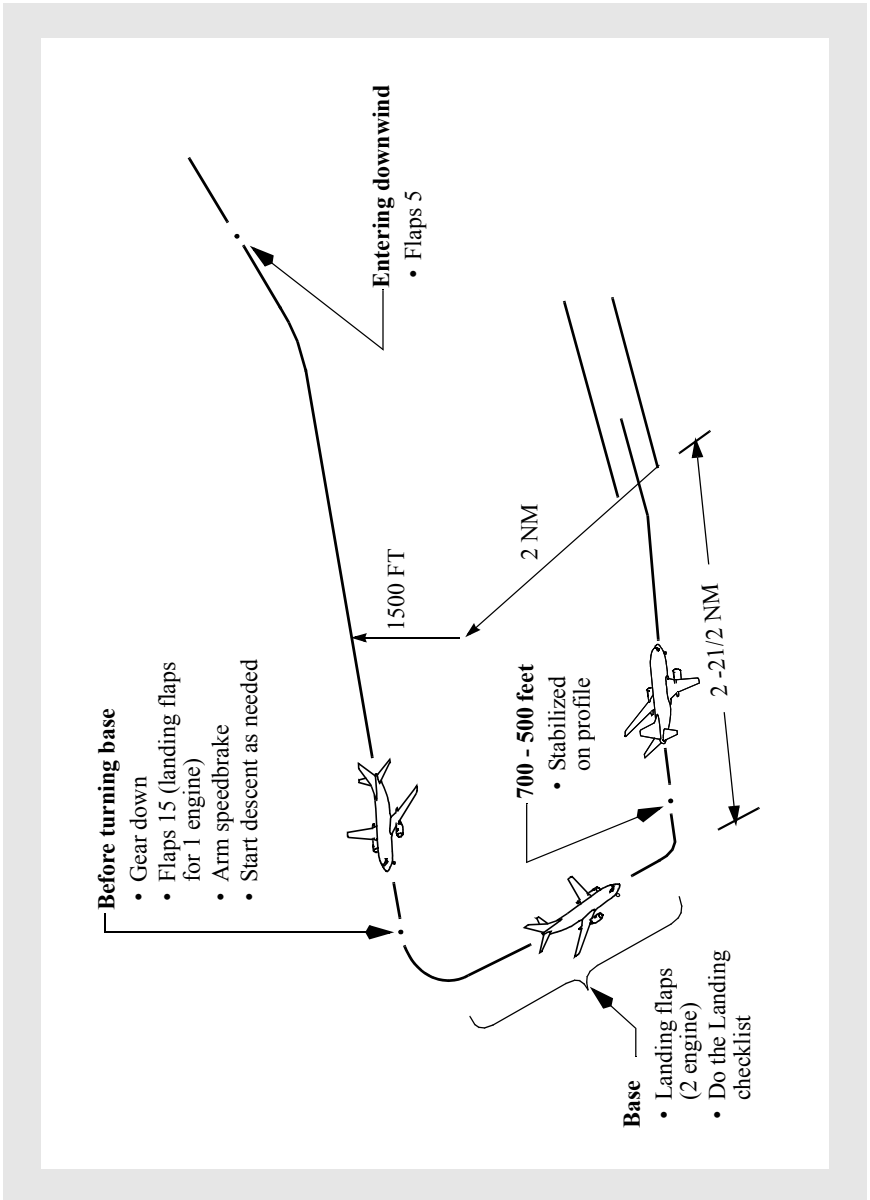

Visual Approach - General

The recommended landing approach path is approximately 2 1/2° to 3°. Once the final approach is established, the airplane configuration remains fixed and only small adjustments to the glide path, approach speed, and trim are necessary. This results in the same approach profile under all conditions.

Thrust

Engine thrust and elevators are the primary means to control attitude and rate of descent. Adjust thrust slowly using small increments. Sudden large thrust changes make airplane control more difficult and are indicative of an unstable approach. No large changes should be necessary except when performing a go-around. Large thrust changes are not required when extending landing gear or flaps on downwind and base leg. A thrust increase may be required when stabilizing on speed on final approach.

Downwind and Base Leg

Fly at an altitude of 1500 feet above the runway elevation and enter downwind with flaps 5 at flaps 5 maneuvering speed. Maintain a track parallel to the landing runway approximately 2 NM abeam.

Before turning base leg, extend the landing gear, select flaps 15, arm the speedbrake, and slow to flaps 15 maneuvering speed or approach speed plus wind correction if landing at flaps 15. If the approach pattern must be extended, delay lowering gear and selecting flaps 15 until approaching the normal visual approach profile. Turning base leg, adjust thrust as required while descending at approximately 600-700 fpm.

Extend landing flaps before turning final. Allow the speed to decrease to the proper final approach speed and trim the airplane. Do the Landing checklist. When established in the landing configuration, maneuvering to final approach may be accomplished at final approach speed (VREF + wind correction).

Final Approach

Roll out of the turn to final on the extended runway centerline and maintain the appropriate approach speed. An altitude of approximately 300 feet above airport elevation for each mile from the runway provides a normal approach profile. Attempt to keep thrust changes small to avoid large trim changes. With the airplane in trim and at target airspeed, pitch attitude should be approximately the normal approach body attitude. At speeds above approach speed, pitch attitude is less. At speeds below approach speed, pitch attitude is higher. Slower speed reduces aft body clearance at touchdown. Stabilize the airplane on the selected approach airspeed with an approximate rate of descent between 700 and 900 feet per minute on the desired glide path, in trim. Stabilize on the profile by 500 feet above touchdown.

Note: Descent rates greater than 1,000 fpm should be avoided.

With one engine inoperative, the rudder trim may be centered before landing. This allows most of the rudder pedal pressure to be removed when the thrust of the operating engine is retarded to idle at touchdown.

Full rudder authority and rudder pedal steering capability are not affected by rudder trim. If touchdown occurs with the rudder still trimmed for the approach, be prepared for the higher rudder pedal forces required to track the centerline on rollout.

Engine Failure On Final Approach

In case of engine failure on visual final approach, use the procedure described in the ILS approach section, this chapter.

Touch and Go Landings

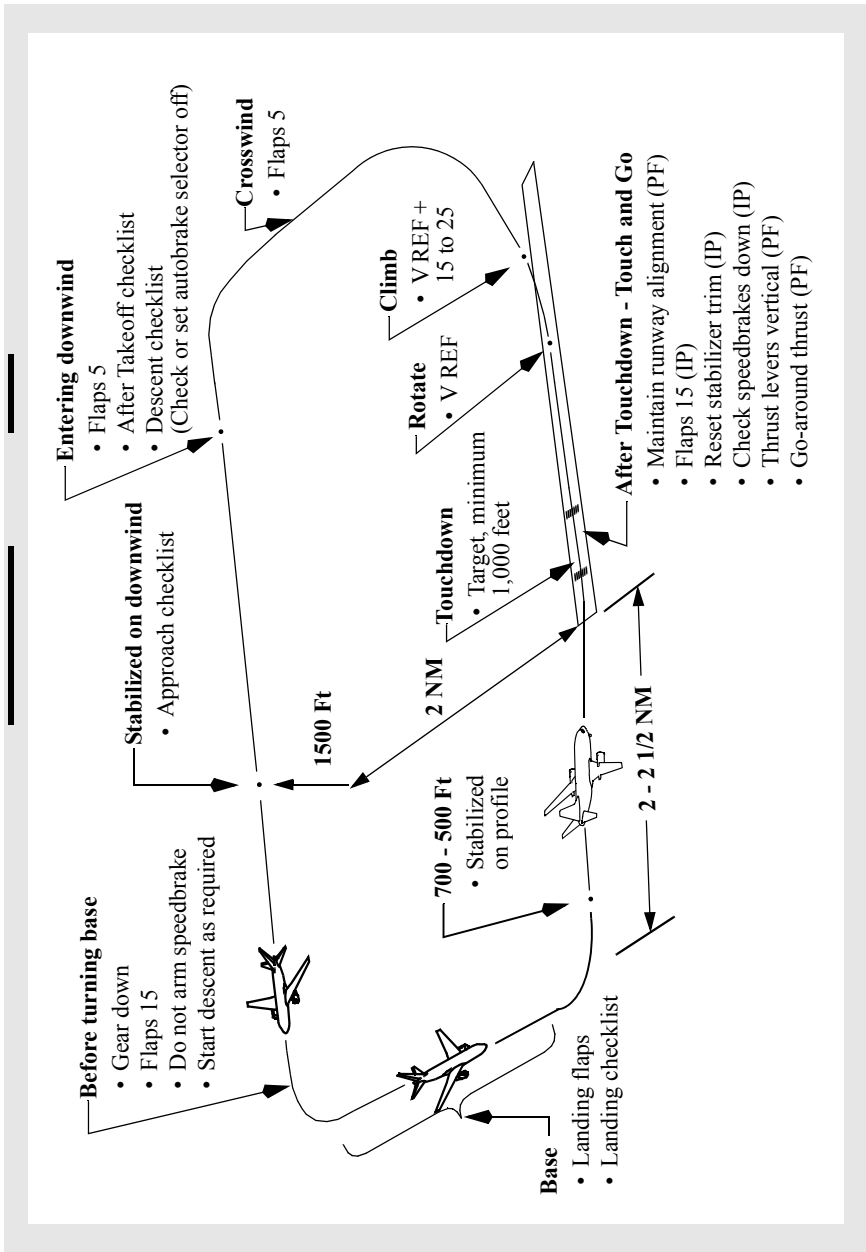

Touch and Go Landing - General

The primary objective of touch and go landings is approach and landing practice. It is not intended for landing roll and takeoff procedure training.

Approach

Accomplish the pattern and approach procedures as illustrated. The landing gear may remain extended throughout the maneuver for brake cooling, but be prepared to retract the landing gear if an actual engine failure occurs during go-around. Do not arm the speedbrakes. Select the autobrakes OFF.

Landing

The trainee should accomplish a normal final approach and landing. After touchdown, the instructor selects flaps 15, sets stabilizer trim, ensures speedbrakes are down, and at the appropriate time instructs the trainee to move the thrust levers to approximately the vertical position (so engines stabilize before applying go-around thrust). When the engines are stabilized, the instructor instructs the trainee to set thrust.

Note: Flaps 15 is recommended after touchdown to minimize the possibility of a tailstrike during the takeoff.

WARNING: After reverse thrust is initiated, a full stop landing must be made.

At VREF, the instructor calls “ROTATE” and the trainee rotates smoothly to approximately 15 ° pitch and climb at VREF + 15 to 25 knots. The takeoff warning horn may sound momentarily if the flaps have not retracted to flaps 15 and the thrust levers are advanced to approximately the vertical position.

Stop and Go Landings

The objective of stop and go landings is to include landing roll, braking, and takeoff procedure practice in the training profile.

Note: At high altitude airports, or on extremely hot days, stop and go landings are not recommended.

After performing a normal full-stop landing, a straight ahead takeoff may be performed if adequate runway is available (FAR field length must be available). After stopping, and before initiating the takeoff, accomplish the following:

- set takeoff flaps
- trim the stabilizer for takeoff
- place speedbrake lever in the down detent
- place autobrake to RTO

- check the rudder trim
- set airspeed bugs for the flap setting to be used.

Perform a normal takeoff.

Do not make repeated full stop landings without allowing time for brake cooling. Brake heating is cumulative and brake energy limits may be exceeded. Flat tires may result.

Note: Flying the pattern with the gear extended assists in brake cooling.

Go-Around and Missed Approach - All Approaches

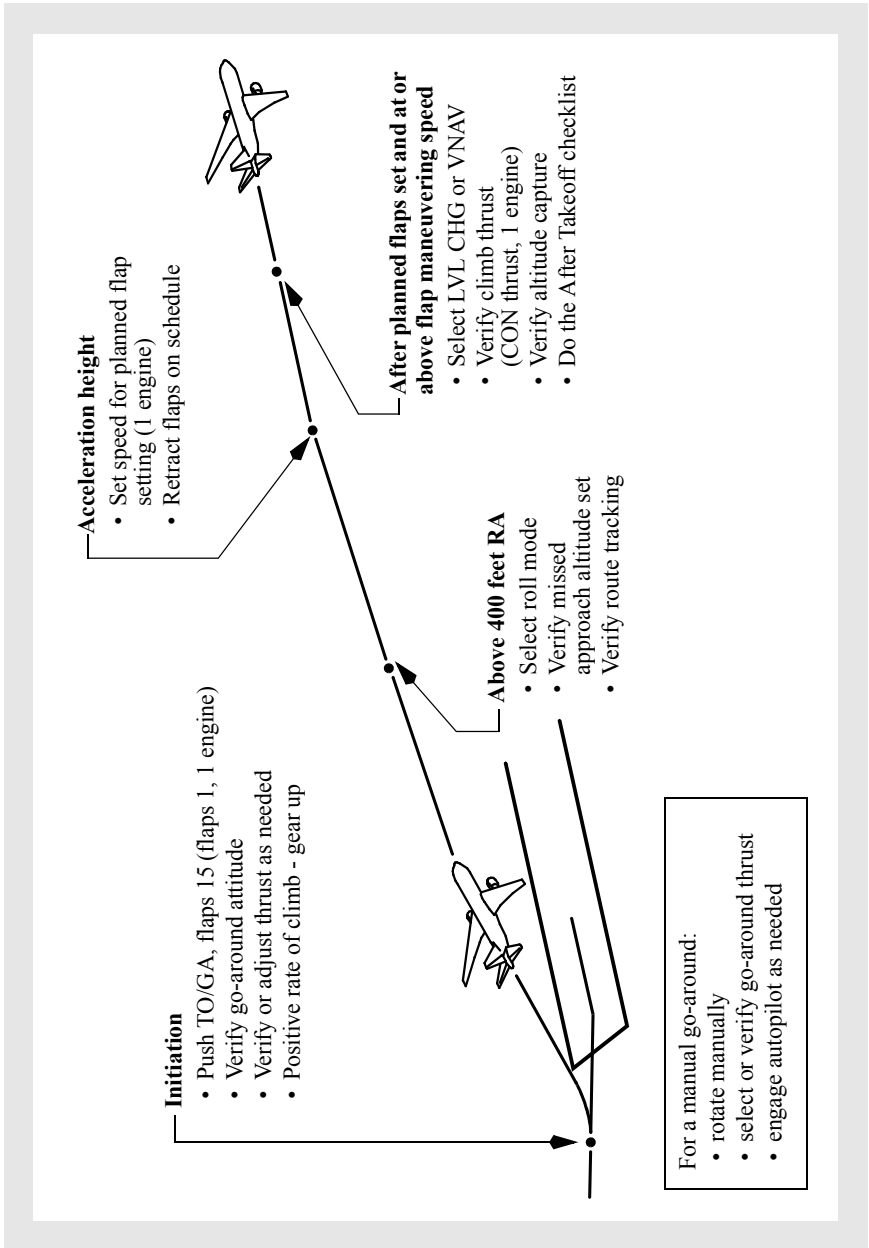

Go-Around and Missed Approach - All Engines Operating

The go-around and missed approach is generally performed in the same manner whether an instrument or visual approach was flown. The go-around and missed approach is flown using the Go-Around and Missed Approach procedure described in the FCOM. The discussion in this section supplements those procedures.

If a missed approach is required following a dual autopilot approach with FLARE arm annunciated, leave the autopilots engaged. Push either TO/GA switch, call for flaps 15, ensure go-around thrust for the nominal climb rate is set and monitor autopilot performance. Retract the landing gear after a positive rate of climb is indicated on the altimeter.

At typical landing weights, actual thrust required for a normal go-around is usually considerably less than maximum go-around thrust. This provides a thrust margin for windshear or other situations requiring maximum thrust. If full thrust is desired after thrust for the nominal climb rate has been established, press TO/GA a second time.

If a missed approach is required following a single autopilot or manual instrument approach, or a visual approach, push either TO/GA switch, call for flaps 15, ensure/set go-around thrust, and rotate smoothly toward 15° pitch attitude. Then follow flight director commands and retract the landing gear after a positive rate of climb is indicated on the altimeter.

Note: Use flaps 1 if a go-around is required from a flaps 15 all engine approach. Bank angles must be limited to 15° until VREF 15 + 15 knots is attained.

During an automatic go-around initiated at 50 feet, approximately 30 feet of altitude is lost. If touchdown occurs after a go-around is initiated, the go-around continues. Observe that the autothrottles apply go-around thrust or manually apply go-around thrust as the airplane rotates to the go-around attitude.

Note: An automatic go-around cannot be initiated after touchdown.

The TO/GA pitch mode initially commands a go-around attitude and then transitions to speed as the rate of climb increases. Command speed automatically moves to a target airspeed for the existing flap position. The TO/GA roll mode maintains existing ground track. Above 400 feet AGL, select a roll mode as appropriate.

737 NG Flight Crew Training Manual

The minimum altitude for flap retraction during a normal takeoff is not normally applicable to a missed approach procedure. However, obstacles in the missed approach flight path must be taken into consideration. During training, use 1,000 feet AGL to initiate acceleration for flap retraction, as during the takeoff procedure.

Note: Selection of pitch and roll modes below 400 feet AGL does not change the autopilot and flight director modes.

Note: When accomplishing a missed approach from a dual-autopilot approach, initial selection of a pitch mode, or when altitude capture occurs above 400 feet AGL the autopilot reverts to single autopilot operation.

If initial maneuvering is required during the missed approach, accomplish the missed approach procedure through gear up before initiating the turn. Delay further flap retraction until initial maneuvering is complete and a safe altitude and appropriate speed are attained.

Command speed automatically increases to maneuvering speed for the existing flap position. Retract flaps on the normal flap/speed schedule. When the flaps are retracted to the desired position and the airspeed approaches maneuvering speed, select LVL CHG and ensure climb thrust is set. VNAV may be selected if the flaps are up. Verify the airplane levels off at selected altitude and proper speed is maintained.

If VNAV is used during go-around, the FMC missed approach profile should contain the appropriate holding speeds and altitudes. Before selecting VNAV, flaps should be retracted because VNAV does not provide overspeed protection for the leading edge devices. Speed intervention (as installed) may be used to further modify airspeed as needed. If VNAV ALT (as installed) is displayed, a premature level off may occur and selection of LVL CHG may be required to complete the climb to the missed approach altitude.

If a diversion to an alternate airport is required, delay use of VNAV until appropriate FMC entries are completed.

Note: FMC speeds may not comply with speed/altitude restrictions when using VNAV at low altitudes.

Go-Around after Touchdown

If a go-around is initiated before touchdown and touchdown occurs, continue with normal go-around procedures. The F/D go-around mode will continue to provide go-around guidance commands throughout the maneuver.

If a go-around is initiated after touchdown but before thrust reverser selection, auto speedbrakes retract and autobrakes disarm as thrust levers are advanced. The F/D go-around mode will not be available until go-around is selected after becoming airborne.

Once reverse thrust is initiated following touchdown, a full stop landing must be made. Factors dictating this are:

- five seconds are required for a reverser to transition to the forward thrust position
- a possibility exists that a reverser may not stow in the forward thrust position.

Go-Around and Missed Approach - One Engine Inoperative

If a missed approach is accomplished from a flaps 15 approach, use flaps 1 for the go-around flap setting. After TO/GA is engaged, the AFDS initially commands a go-around attitude, then transitions to maintain command speed as the rate of climb increases. The pilot must control yaw with rudder and trim. Some rudder pedal pressure may be required even with full rudder trim. Select maximum continuous thrust when flaps are retracted to the desired flap setting.

For fail operational airplanes, if a missed approach is accomplished from a flaps 30 approach, perform a flaps 15 go-around. Follow Go-Around and Missed Approach procedures. After TO/GA is engaged, the AFDS initially commands a go-around attitude, then transitions to maintain command speed as the rate of climb increases. If the missed approach is initiated after LAND 2 or LAND 3 is annunciated, yaw is initially controlled by the autopilots. Be prepared to immediately apply rudder input when selecting another roll mode, pitch mode, or when altitude capture occurs above 400 feet AGL because the autopilot reverts to single autopilot operation. The system reverts to normal autopilot operation and automatic control of rudder is discontinued.

Engine Failure During Go-Around and Missed Approach

If an engine fails during go-around, perform normal Go-Around and Missed Approach procedures. Verify maximum go-around thrust is set. Maintain flaps 15, VREF 30 or 40 + wind correction (5 knots minimum) speed and limit bank angle to 15° until initial maneuvering is complete and a safe altitude is reached. Accelerate to flap retraction speed by repositioning the command speed to the maneuvering speed for the desired flap setting and adjusting pitch. Retract flaps on the normal flap/speed schedule.



Landing

Table of Contents

Chapter 6

Section TOC

Preface 6.1

Landing Configurations and Speeds 6.1

 Maneuver Margin 6.1

 Non-Normal Landing Configurations and Speeds 6.1

 Non-Normal Landing Distance 6.2

Visual Approach Slope Indicator (VASI/T - VASI) 6.3

 Three Bar VASI/T - VASI 6.4

 VASI Landing Geometry 6.5

Precision Approach Path Indicator (PAPI) 6.7

 PAPI Landing Geometry 6.7

Landing Geometry 6.7

 Visual Aim Point 6.7

 Runway Markings (Typical) 6.8

 Threshold Height 6.9

Flare and Touchdown 6.9

 Landing Flare Profile 6.9

 Bounced Landing Recovery 6.10

 Rejected Landing 6.11

 Normal Touchdown Attitude 6.11

 Body Clearance at Touchdown 6.16

 Pitch and Roll Limit Conditions 6.20

Landing Roll 6.22

 Speedbrakes 6.22

 Directional Control and Braking during Landing Roll 6.23



Factors Affecting Landing Distance	6.23
Wheel Brakes	6.27
Reverse Thrust Operation	6.30
Crosswind Landings	6.34
Landing Crosswind Guidelines	6.34
Crosswind Landing Techniques	6.35
Overweight Landing	6.36
Overweight Autolands Policy	6.37



Preface

This chapter outlines recommended operating practices and techniques for landing, rejected landings and landing roll. Techniques are provided to help the pilot effectively utilize approach lighting, control the airplane during crosswind landings and maintain directional control after landing. Additionally, information on factors affecting landing distance and landing geometry is provided.

Landing Configurations and Speeds

Flaps 15 (except JAA), 30 (for noise abatement) and 40 are normal landing flap positions. Flaps 15 is normally limited to airports where approach climb performance is a factor. Runway length and condition must be taken into account when selecting a landing flap position.

Maneuver Margin

Flight profiles should be flown at, or slightly above, the recommended maneuvering speed for the existing flap configuration. These speeds approximate maximum fuel economy and allow full maneuvering capability (25° bank with a 15° overshoot).

Full maneuver margin exists for all normal and non-normal landing procedures whenever speed is at or above the maneuver speed for the current flap setting. Full maneuver margin exists with flaps 15 at VREF 30 + 5 or VREF 40 + 5 during a go-around at go-around thrust.

Airspeeds recommended for non-normal flight profiles are intended to restore near normal maneuvering margins and/or aerodynamic control response.

The configuration changes are based on maintaining full maneuvering and/or maximum performance unless specified differently in individual procedures. It is necessary to apply wind correction to the VREF speeds. See the Command Speed section in chapter 1 for an explanation of wind corrections.

Non-Normal Landing Configurations and Speeds

The Non-Normal Configuration Landing Distance table in the PI chapter of the QRH shows speeds and landing distances for various non-normal landing configurations and runway conditions. The target speed for the approach is the appropriate approach VREF plus the wind and gust additives.



Non-Normal Landing Distance

Because of higher approach speeds associated with the non-normal landing condition the actual landing distance is increased. The flight crew should review the Non-Normal Configuration Landing Distance information in the PI chapter of the QRH.

Visual Approach Slope Indicator (VASI/T - VASI)

The VASI is a system of lights arranged to provide visual descent guidance information during the approach. All VASI systems are visual projections of the approach path normally aligned to intersect the runway at a point 1,000 or 1,800 feet beyond the threshold. Flying the VASI glide slope to touchdown is the same as selecting a visual aim point on the runway adjacent to the VASI installation.

When using a two-bar VASI, the difference between the eye reference path and the gear path results in a normal approach and threshold height. It provides useful information in alerting the crew to low profile situations.

Some airports have three-bar VASI which provides two visual glide paths. The additional light bar is located upwind from a standard two-bar installation. When the airplane is on the glide path, the pilot sees the one white bar and two red bars. Three-bar VASI may be safely used with respect to threshold height, but may result in landing further down the runway.

For a T-VASI, flying the approach with one additional white fly down light visible provides additional wheel clearance.

Three Bar VASI/T - VASI

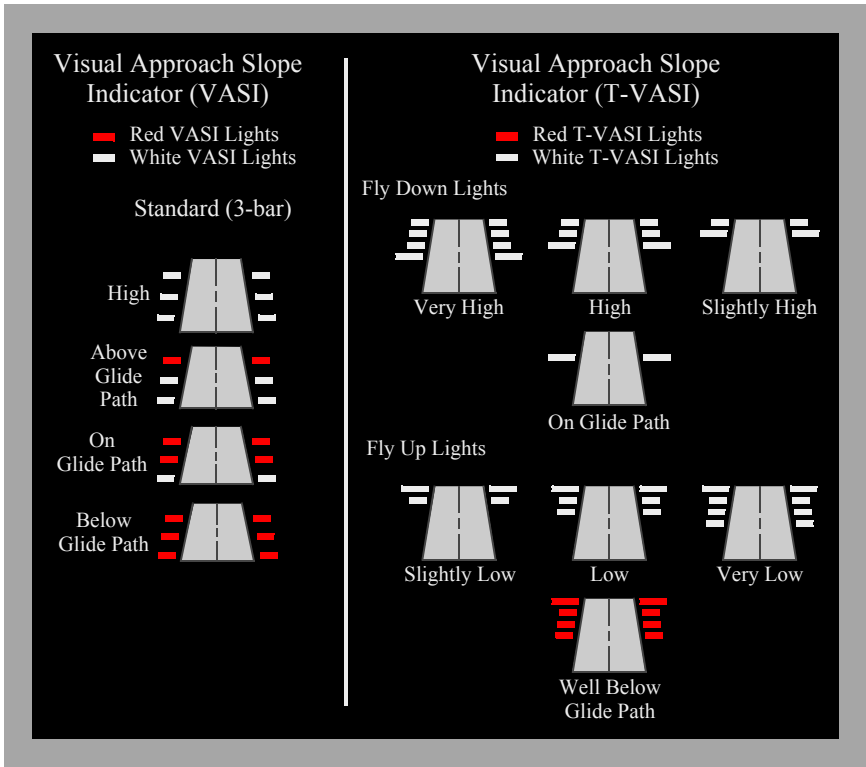

VASI Landing Geometry

Two-bar VASI installations provide one visual glide path which is normally set at 3°. Three-bar VASI installations provide two visual glide paths. The lower glide path is provided by the near and middle bars and is normally set at 3° while the upper glide path, provided by the middle and far bars, is normally 1/4° higher (3.25°). This higher glide path is intended for use only by high cockpit (long wheelbase) airplanes to provide a sufficient threshold crossing height.

Two Bar VASI Landing Geometry

The following diagrams use these conditions:

- data is based upon typical landing weight
- airplane body attitudes are based on Flaps 30 and Flaps 40, VREF (for the flap setting used) + 5 and should be reduced by 1° for each 5 knots above this speed.
- eye height is calculated at the moment the main gear is over the threshold.

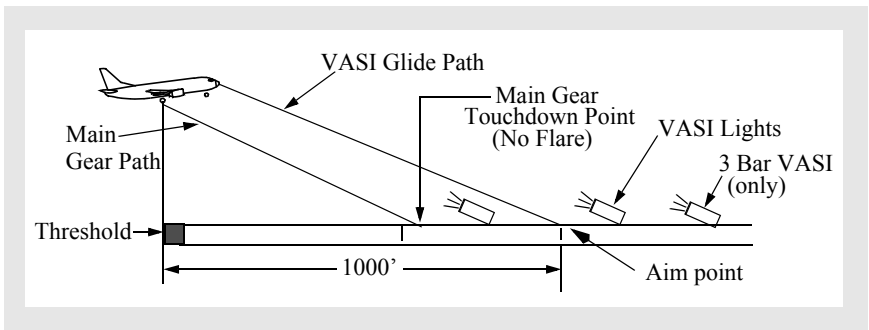

Flaps 30			AIM Point at 1,000 Feet		
737 Model	Visual Glide Path (degrees)	Airplane Body Attitude (degrees)	Threshold Height		Main Gear Touchdown Point - no flare (feet)
			Pilot Eye Height (feet)	Main Gear Height (feet)	
-600	3.0	3.7	50	36	657
-700	3.0	3.7	50	34	647
-800	3.0	2.4	49	34	651
-900	3.0	1.6	49	35	659



737 NG Flight Crew Training Manual

Flaps 40			AIM Point at 1,000 Feet		
737 Model	Visual Glide Path in (degrees)	Airplane Body Attitude (degrees)	Threshold Height		Main Gear Touchdown Point - no flare (feet)
			Pilot Eye Height (feet)	Main Gear Height (feet)	
-600	3.0	2.0	50	36	683
-700	3.0	2.0	50	35	675
-800	3.0	1.4	49	35	671
-900	3.0	0.9	49	34	644

Precision Approach Path Indicator (PAPI)

The PAPI uses lights which are normally on the left side of the runway. They are similar to the VASI, but are installed in a single row of light units.

When the airplane is on a normal 3° glide path, the pilot sees two white lights on the left and two red lights on the right. The PAPI may be safely used with respect to threshold height, but may result in landing further down the runway. The PAPI is normally aligned to intersect the runway 1,000 to 1,500 feet down the runway.

PAPI Landing Geometry

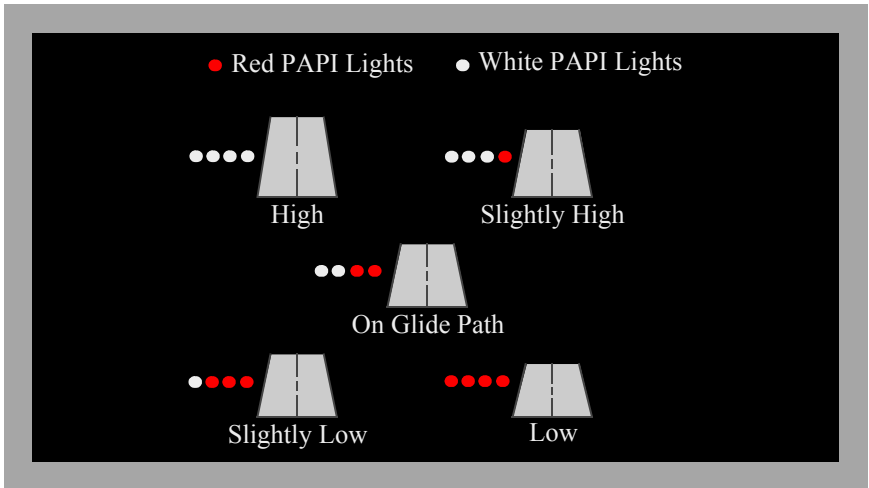

Landing Geometry

Visual Aim Point

During visual approaches many techniques and methods are used to ensure main landing gear touchdown at the desired point on the runway. One of the most common methods used is to aim at the desired gear touchdown point on the runway, then adjust the final approach glide path until the selected point appears stationary in relation to the airplane (the point does not move up or down in the pilot's field of view during the approach).

Visual aim points versus gear touchdown point differences increase as glide path angle decreases as in a flat approach. For a particular visual approach, the difference between gear path and eye level path must be accounted for by the pilot.

Runway Markings (Typical)

The following runway markings are for runways served by a precision approach.

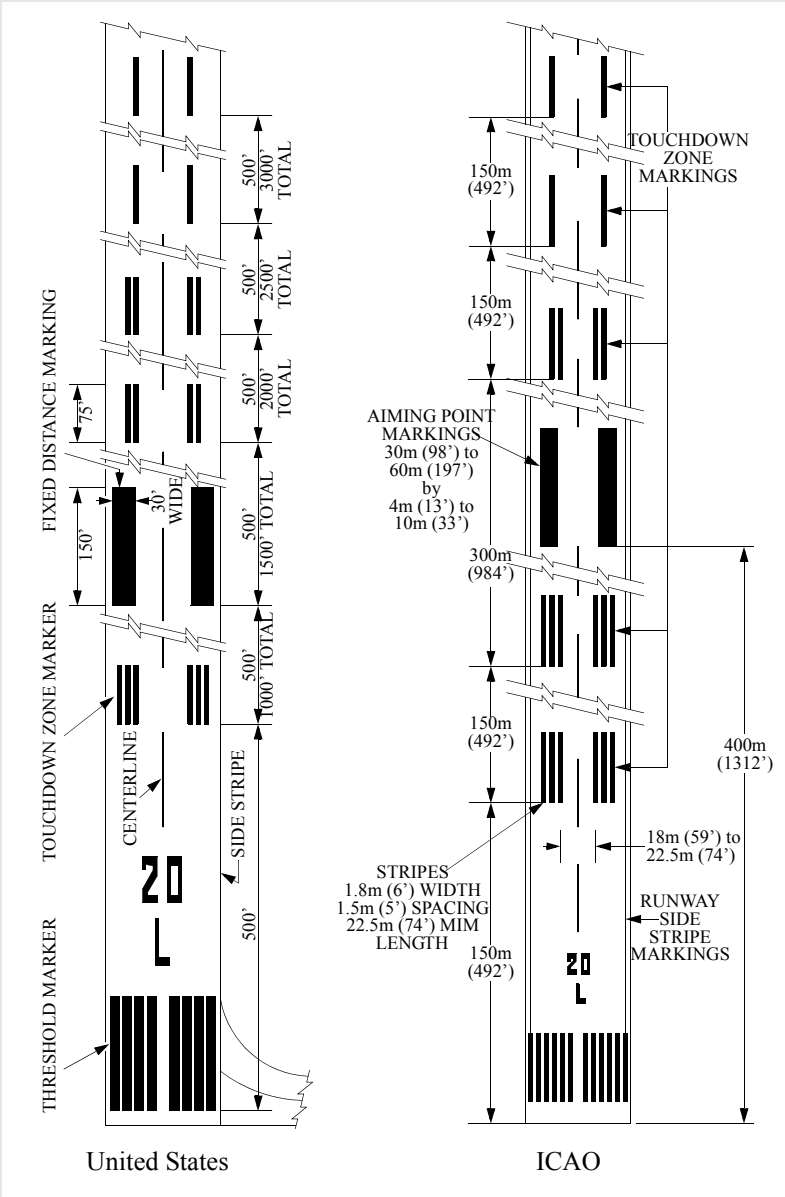

Threshold Height

Threshold height is a function of glide path angle and landing gear touchdown target. Threshold height for main gear and pilot eye level is shown in the Two Bar/Three Bar VASI Landing Geometry tables on a previous page. Special attention must be given to establishing a final approach that assures safe threshold clearance and gear touchdown at least 1,000 feet down the runway. If automatic callouts are not available, the radio altimeter should be used to assist the pilot in judging terrain clearance, threshold height and flare initiation height.

Flare and Touchdown

The techniques discussed here are applicable to all landings including one engine inoperative landings, crosswind landings and landings on slippery runways. Unless an unexpected or sudden event occurs, such as windshear or collision avoidance situation, it is not appropriate to use sudden, violent or abrupt control inputs during landing. Begin with a stabilized approach on speed, in trim and on glide path.

When the threshold passes under the airplane nose and out of sight, shift the visual sighting point to approximately 3/4 the runway length. Shifting the visual sighting point assists in controlling the pitch attitude during the flare. Maintaining a constant airspeed and descent rate assists in determining the flare point. Initiate the flare when the main gear is approximately 15 feet above the runway by increasing pitch attitude approximately 2° - 3°. This slows the rate of descent.

After the flare is initiated, smoothly retard the thrust levers to idle, and make small pitch attitude adjustments to maintain the desired descent rate to the runway. Ideally, main gear touchdown should occur simultaneously with thrust levers reaching idle. A smooth power reduction to idle also assists in controlling the natural nose-down pitch change associated with thrust reduction. Hold sufficient back pressure on the control column to keep the pitch attitude constant. A touchdown attitude as depicted in the figure below is normal with an airspeed of approximately VREF plus any gust correction.

Note: Do not trim during the flare or after touchdown. Trimming in the flare increases the possibility of a tailstrike.

Landing Flare Profile

The following diagrams use these conditions:

- 3° approach glide path
- flare distance is approximately 1,000 to 2,000 feet beyond the threshold

- typical landing flare times range from 4 to 8 seconds and are a function of approach speed
- airplane body attitudes are based upon typical landing weights, flaps 30, VREF 30 + 5 (approach) and VREF 30 + 0 (landing), and should be reduced by 1° for each 5 knots above this speed.

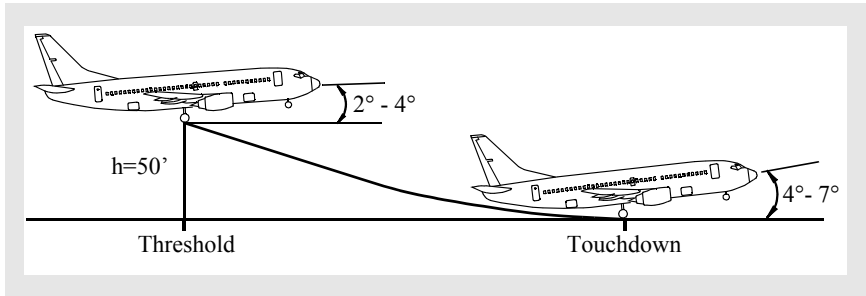

Typically, the pitch attitude increases slightly during the actual landing, but avoid over-rotating. Do not increase the pitch attitude after touchdown; this could lead to a tail strike.

Shifting the visual sighting point down the runway assists in controlling the pitch attitude during the flare. A smooth power reduction to idle also assists in controlling the natural nose down pitch change associated with thrust reduction. Hold sufficient back pressure on the control column to keep the pitch attitude constant.

Avoid rapid control column movements during the flare. Do not use pitch trim during flare or after touchdown. Such actions are likely to cause the pitch attitude to increase at touchdown and increase the potential for a tailstrike. Do not allow the airplane to float; fly the airplane onto the runway. Do not extend the flare by increasing pitch attitude in an attempt to achieve a perfectly smooth touchdown.

Do not attempt to hold the nose wheels off the runway.

Bounced Landing Recovery

If the airplane should bounce, hold or re-establish a normal landing attitude and add thrust as necessary to control the rate of descent. Thrust need not be added for a shallow bounce or skip. When a high, hard bounce occurs, initiate a go-around. Apply go-around thrust and use normal go-around procedures. Do not retract the landing gear until a positive rate of climb is established because a second touchdown may occur during the go-around.

737 NG Flight Crew Training Manual

Bounced landings can occur because higher than idle power is maintained through initial touchdown, disabling the automatic speedbrake deployment even when the speedbrakes are armed. During the resultant bounce, if the thrust levers are then retarded to idle, automatic speedbrake deployment can occur resulting in a loss of lift and nose up pitching moment which can result in a tail strike or hard landing on a subsequent touchdown.

Rejected Landing

A rejected landing maneuver is trained and evaluated by some operators and regulatory agencies. Although the FCOM/QRH does not contain a procedure or maneuver titled Rejected Landing, the requirements of this maneuver can be accomplished by doing the Go-Around Procedure if it is initiated prior to touchdown. Refer to Chapter 5, Go-Around after Touchdown, for more information on this subject.

Normal Touchdown Attitude

The following figures illustrate the effect of airspeed on body attitude on touchdown. It shows normal touchdown attitude for flaps 30. If flare control and thrust are excessive near touchdown, the airplane tends to float in ground effect.

With proper airspeed control and thrust management, touchdown occurs at no less than VREF - 5. The illustration shows that touchdown at a speed significantly below VREF seriously reduces aft fuselage-runway clearance.

Touchdown Body Attitudes

737-600

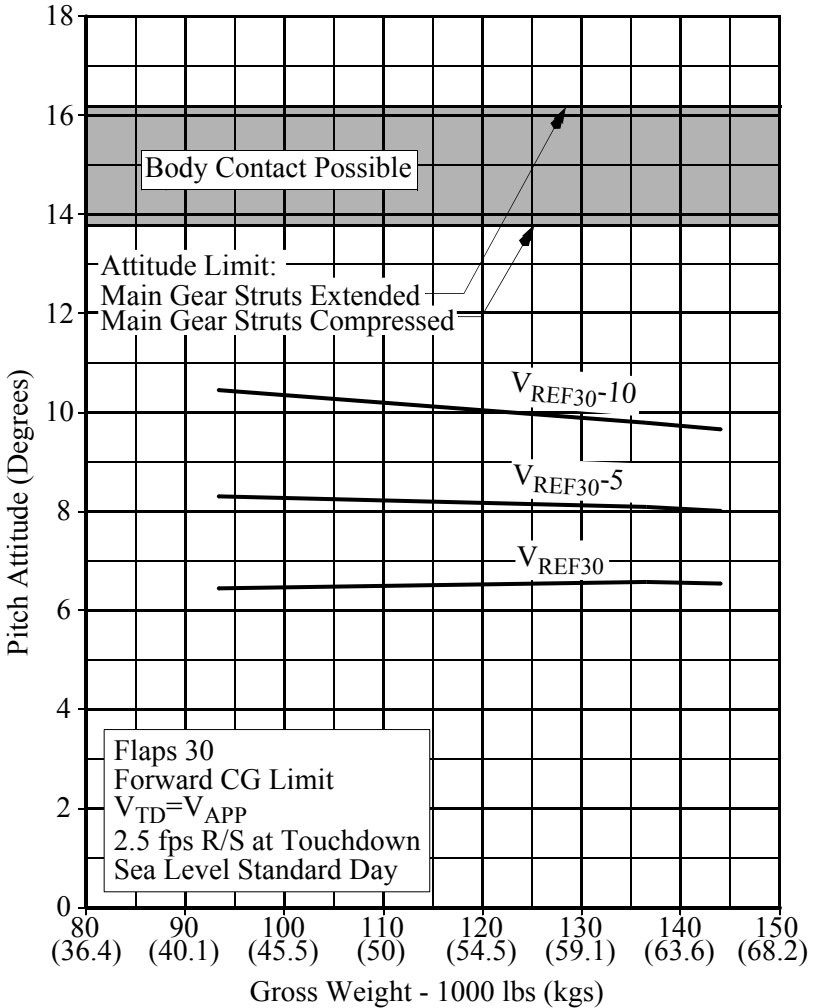

737 NG Flight Crew Training Manual

737-700

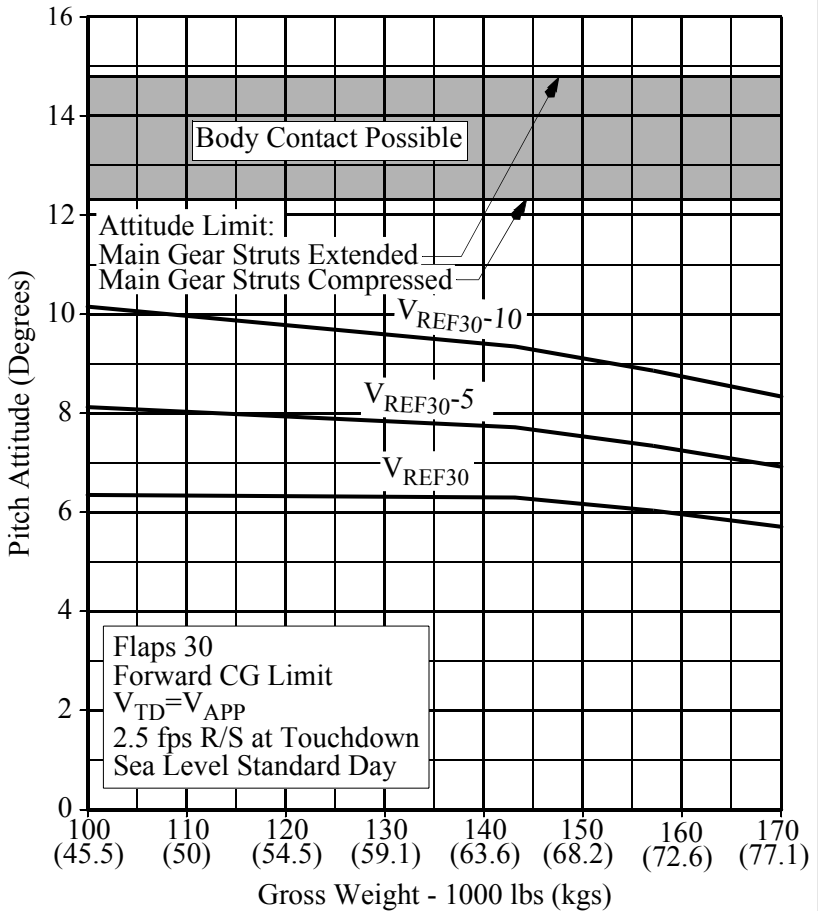

737-800

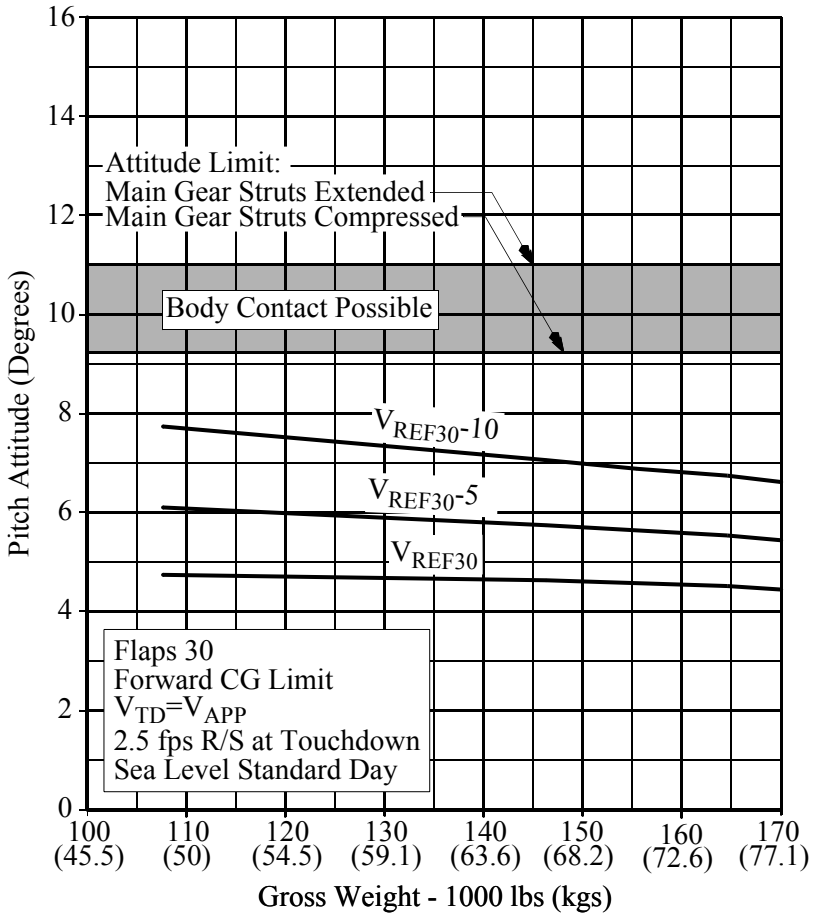

737 NG Flight Crew Training Manual

737-900

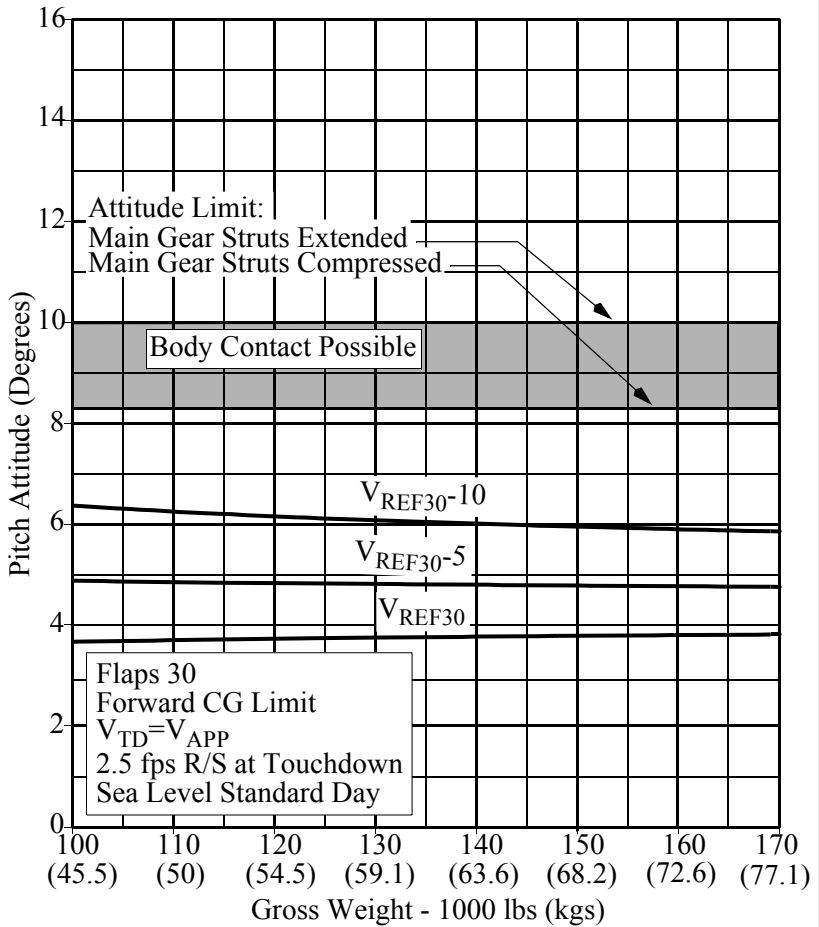

Body Clearance at Touchdown

The following figures show aft fuselage-runway clearance in relation to pitch angle with all main gear tires on the runway.

Body Clearance above Ground

737-600

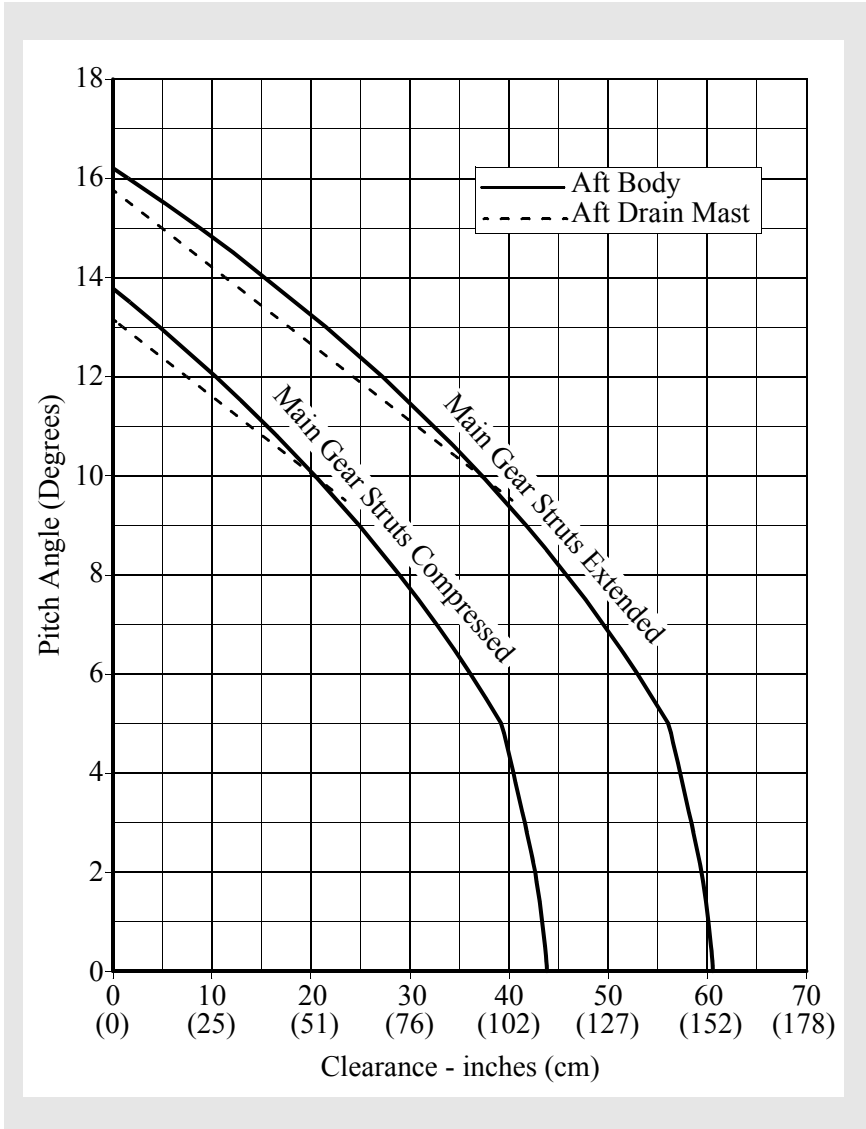

737 NG Flight Crew Training Manual

737-700

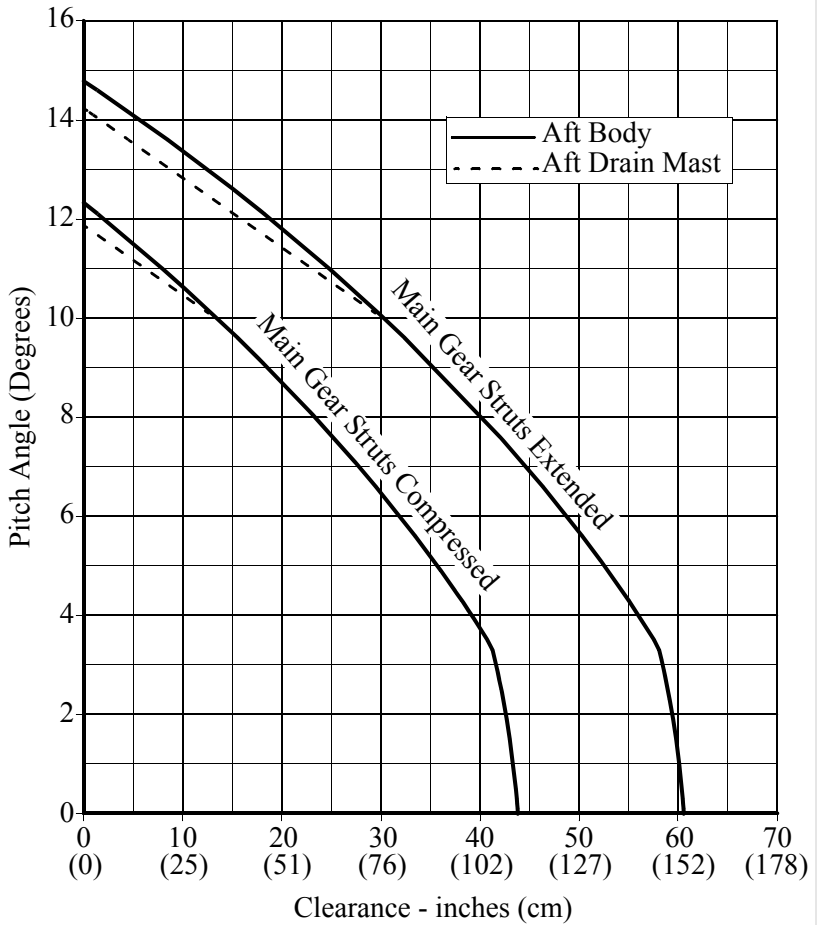

737-800

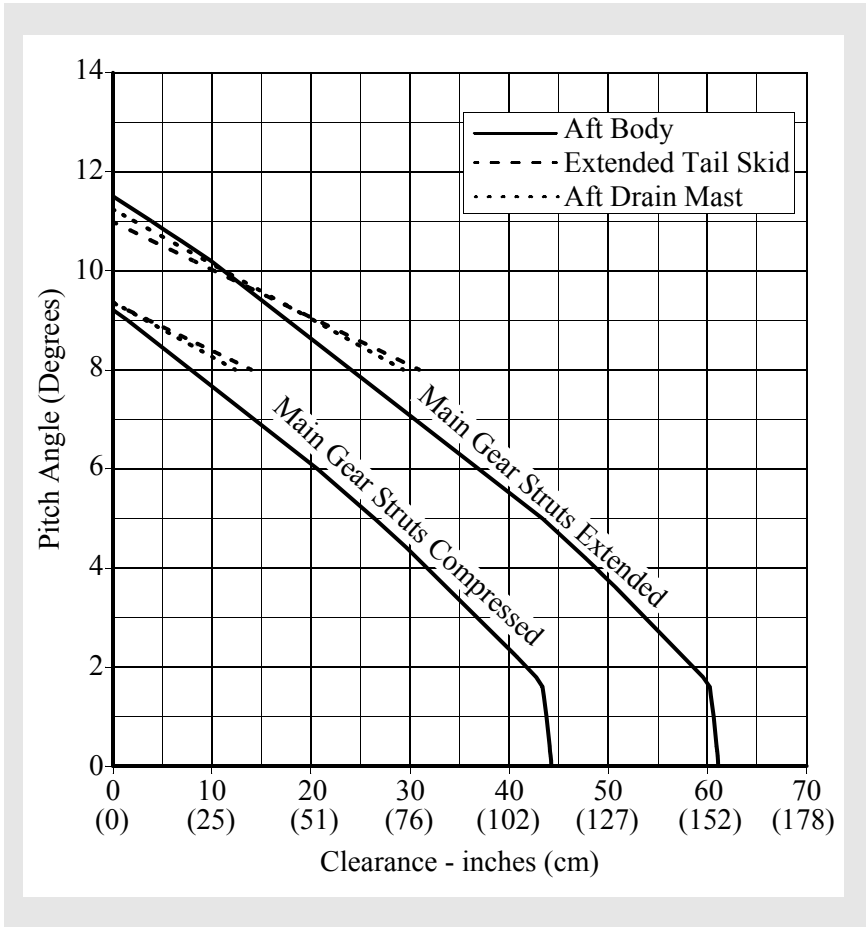

737 NG Flight Crew Training Manual

737-900

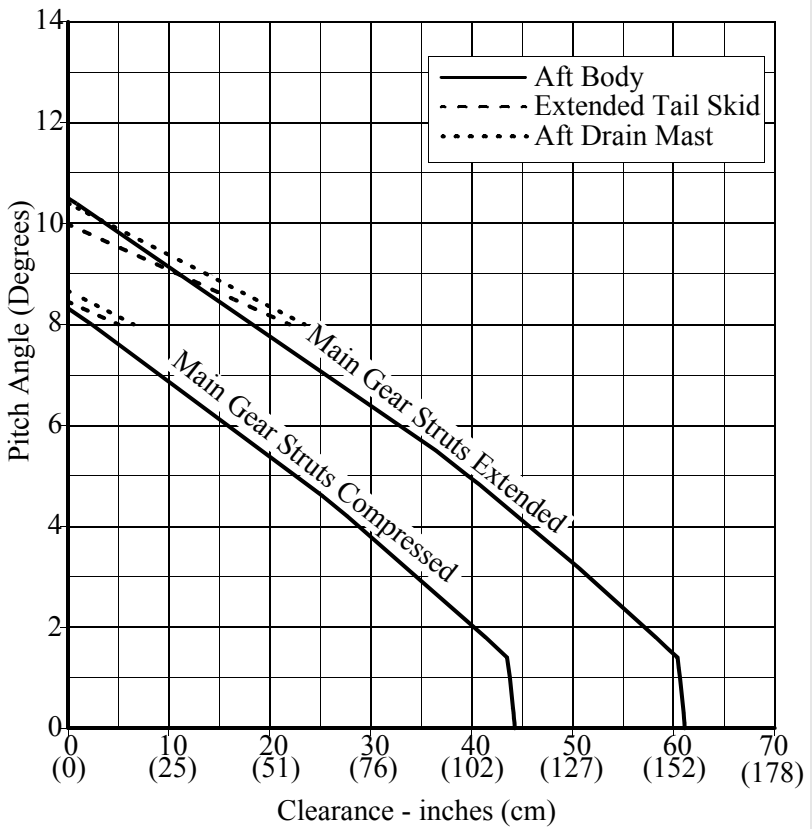



Pitch and Roll Limit Conditions

The Ground Contact Angles - Normal Landing figure illustrates body roll angle/pitch angles at which the airplane structure contacts the runway. Prolonged flare increases the body pitch attitude 2° to 3°. When prolonged flare is coupled with a misjudged height above the runway aft body contact is possible.

Fly the airplane onto the runway at the desired touchdown point and at the desired airspeed. Do not hold it off and risk the possibility of a tailstrike.

Note: A smooth touchdown is not the criterion for a safe landing.

737 NG Flight Crew Training Manual

Ground Contact Angles - Normal Landing

Conditions

- Pitch about main gear centerline
- Slats fully extended
- Aileron full down
- Roll about outer tire centerline
- Stabilizer full nose up
- Elevator full down
- Struts compressed
- Flaps 40

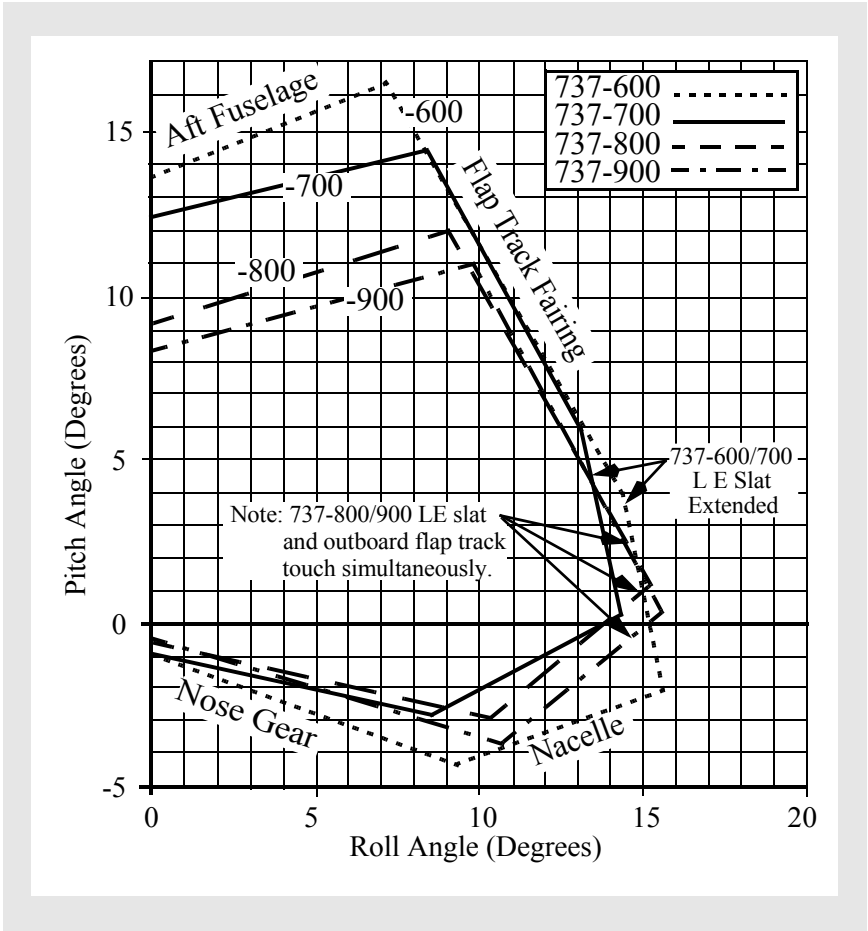

Landing Roll

Avoid touching down with thrust above idle since this may establish an airplane nose up pitch tendency and increases landing roll.

After main gear touchdown, initiate the landing roll procedure. If the speedbrakes do not extend automatically move the speedbrake lever to the UP position without delay. Fly the nosewheel onto the runway smoothly by relaxing aft control column pressure. Control column movement forward of neutral should not be required. Do not attempt to hold the nosewheel off the runway. Holding the nose up after touchdown for aerodynamic braking is not an effective braking technique.

To avoid possible airplane structural damage, do not make large nose down control column movements before the nose wheels are lowered to the runway.

To avoid the risk of tailstrike, do not allow the pitch attitude to increase after touchdown. However, applying excessive nose down elevator during landing can result in substantial forward fuselage damage. Do not use full down elevator. Use an appropriate autobrake setting or manually apply wheel brakes smoothly with steadily increasing pedal pressure as required for runway condition and runway length available. Maintain deceleration rate with constant or increasing brake pressure as required until stopped or desired taxi speed is reached.

Speedbrakes

The speedbrake system is controlled with the SPEEDBRAKE lever (which is moved UP and DOWN). The speedbrake system consists of individual spoiler panels which the pilot can extend and retract by moving the SPEEDBRAKE lever.

The speedbrakes can be fully raised after touchdown while the nose wheels are lowered to the runway, with no adverse pitch effects. The speedbrakes spoil the lift from the wings, which places the airplane weight on the main landing gear, providing excellent brake effectiveness.

Unless speedbrakes are raised after touchdown, braking effectiveness may be reduced initially as much as 60%, since very little weight is on the wheels and brake application may cause rapid anti-skid modulation.

Normally, speedbrakes are armed to extend automatically. Both pilots should monitor speedbrake extension after touchdown. In the event auto extension fails, the speedbrake should be manually extended immediately.

Pilot awareness of the position of the speedbrake lever during the landing phase is important in the prevention of over-run. The position of the speedbrakes should be announced during the landing phase by the PM. This improves the crew's situational awareness of the position of the spoilers during landing and builds good habit patterns which can prevent failure to observe a malfunctioned or disarmed spoiler system.

Directional Control and Braking during Landing Roll

If the nose wheels are not promptly lowered to the runway, braking and steering capabilities are significantly degraded and no drag benefit is gained. Rudder control is effective to approximately 60 knots. Rudder pedal steering is sufficient for maintaining directional control during the rollout. Do not use the nose wheel steering wheel until reaching taxi speed. In a crosswind, displace the control wheel into the wind to maintain wings level which aids directional control. Perform the landing roll procedure immediately after touchdown. Any delay markedly increases the stopping distance.

Stopping distance varies with wind conditions and any deviation from recommended approach speeds.

Factors Affecting Landing Distance

Advisory information for normal and non-normal configuration landing distances is contained in the PI section of the QRH. Actual stopping distances for a maximum effort stop are approximately 60% of the dry runway field length requirement. Factors that affect stopping distance include: height and speed over the threshold, glide slope angle, landing flare, lowering the nose to the runway, use of reverse thrust, speedbrakes, wheel brakes and surface conditions of the runway.

Note: Reverse thrust and speedbrake drag are most effective during the high speed portion of the landing. Deploy the speedbrake lever and activate reverse thrust with as little time delay as possible.

Note: Speedbrakes fully deployed, in conjunction with maximum reverse thrust and maximum manual anti-skid braking provides the minimum stopping distance.

Floating above the runway before touchdown must be avoided because it uses a large portion of the available runway. The airplane should be landed as near the normal touchdown point as possible. Deceleration rate on the runway is approximately three times greater than in the air.

Height of the airplane over the runway threshold also has a significant effect on total landing distance. For example, on a 3° glide path, passing over the runway threshold at 100 feet altitude rather than 50 feet could increase the total landing distance by approximately 950 feet. This is due to the length of runway used up before the airplane actually touches down.

Glide path angle also affects total landing distance. As the approach path becomes flatter, even while maintaining proper height over the end of the runway, total landing distance is increased.

Slippery Runway Landing Performance

When landing on slippery runways contaminated with ice, snow, slush or standing water, the reported braking action must be considered. Advisory information for reported braking actions of good, medium and poor is contained in the PI section of the QRH. The performance level associated with good is representative of a wet runway. The performance level associated with poor is representative of a wet ice covered runway. Also provided in the QRH are stopping distances for the various autobrake settings and for non-normal configurations. Pilots should use extreme caution to ensure adequate runway length is available when poor braking action is reported.

Pilots should keep in mind slippery/contaminated runway advisory information is based on an assumption of uniform conditions over the entire runway. This means a uniform depth for slush/standing water for a contaminated runway or a fixed braking coefficient for a slippery runway. The data cannot cover all possible slippery/contaminated runway combinations and does not consider factors such as rubber deposits or heavily painted surfaces near the end of most runways. With these caveats in mind, it is up to the airline to determine operating policies based on the training and operating experience of their flight crews.

One of the commonly used runway descriptors is coefficient of friction. Ground friction measuring vehicles typically measure this coefficient of friction. Much work has been done in the aviation industry to correlate the friction reading from these ground friction measuring vehicles to airplane performance. Use of ground friction vehicles raises the following concerns:

- the measured coefficient of friction depends on the type of ground friction measuring vehicle used. There is not a method, accepted worldwide, for correlating the friction measurements from the different friction measuring vehicles to each other, or to the airplane's braking capability.
- most testing to date, which compares ground friction vehicle performance to airplane performance, has been done at relatively low speeds (100 knots or less). The critical part of the airplane's deceleration characteristics is typically at higher speeds (120 to 150 knots).

737 NG Flight Crew Training Manual

- ground friction vehicles often provide unreliable readings when measurements are taken with standing water, slush or snow on the runway. Ground friction vehicles might not hydroplane (aquaplane) when taking a measurement while the airplane may hydroplane (aquaplane). In this case, the ground friction vehicles would provide an optimistic reading of the runway's friction capability. The other possibility is the ground friction vehicles might hydroplane (aquaplane) when the airplane would not, this would provide an overly pessimistic reading of the runway's friction capability. Accordingly, friction readings from the ground friction vehicles may not be representative of the airplane's capability in hydroplaning conditions.
- ground friction vehicles measure the friction of the runway at a specific time and location. The actual runway coefficient of friction may change with changing atmospheric conditions such as temperature variations, precipitation etc. Also, the runway condition changes as more operations are performed.

The friction readings from ground friction measuring vehicles do supply an additional piece of information for the pilot to evaluate when considering runway conditions for landing. Crews should evaluate these readings in conjunction with the PIREPS (pilot reports) and the physical description of the runway (snow, slush, ice etc.) when planning the landing. Special care should be taken in evaluating all the information available when braking action is reported as POOR or if slush/standing water is present on the runway.

Factors Affecting Landing Distance (Typical)

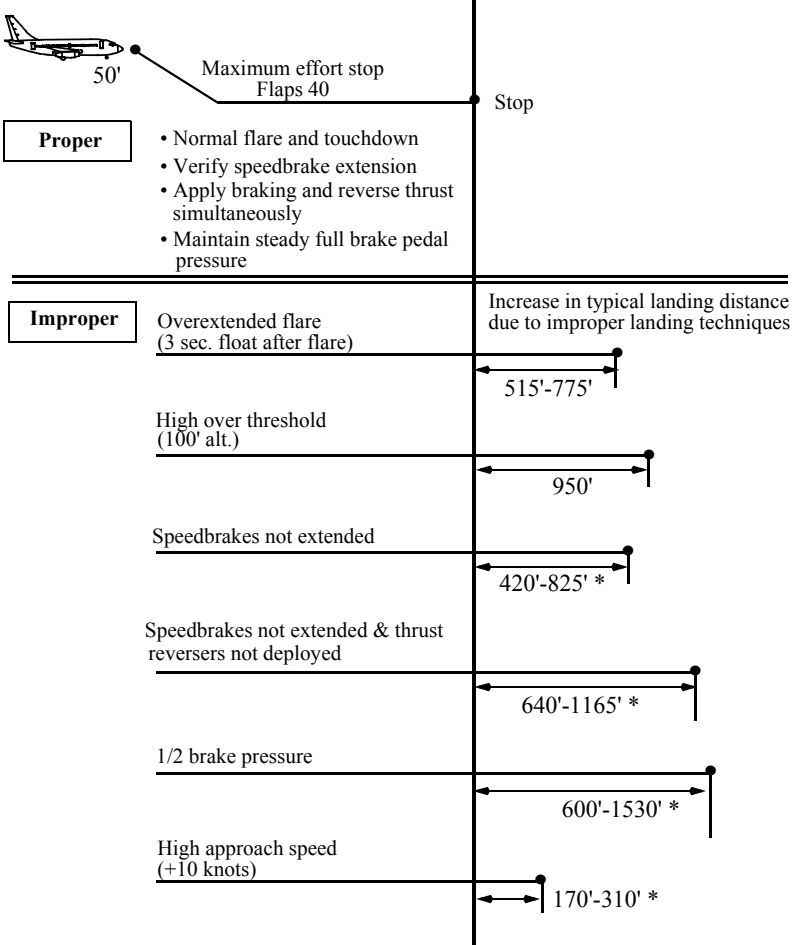

*Landing distance varies with runway condition, wet or dry. Data excludes contaminated runway considerations.

Wheel Brakes

Braking force is proportional to the force of the tires on the runway and the coefficient of friction between the tires and the runway. The contact area normally changes little during the braking cycle. The perpendicular force comes from airplane weight and any downward aerodynamic force such as speedbrakes.

The coefficient of friction depends on the tire condition and runway surface, (e.g. concrete, asphalt, dry, wet or icy).

Automatic Brakes

Boeing recommends that whenever runway limited, using higher than normal approach speeds, landing on slippery runways or landing in a crosswind, the autobrake system be used.

For normal operation of the autobrake system select a deceleration setting.

Settings include:

- **MAX:** Used when minimum stopping distance is required. Deceleration rate is less than that produced by full manual braking
- **MED (2 or 3, as installed):** Should be used for wet or slippery runways or when landing rollout distance is limited
- **MIN (1, as installed):** These settings provide a moderate deceleration effect suitable for all routine operations.

Flight crew/airline experience with airplane characteristics relative to the various runway conditions routinely encountered provide initial guidance as to the desirable level of deceleration selected.

Immediate initiation of reverse thrust at main gear touchdown and full reverse thrust allow the autobrake system to reduce brake pressure to the minimum level. Since the autobrake system senses deceleration and modulates brake pressure accordingly, the proper application of reverse thrust results in reduced braking for a large portion of the landing roll.

The importance of establishing the desired reverse thrust level as soon as possible after touchdown cannot be overemphasized. This minimizes brake temperatures and tire and brake wear and reduces stopping distance on very slippery runways.

The use of minimum reverse thrust almost doubles the brake energy requirements and can result in brake temperatures much higher than normal.

After touchdown, crewmembers should be alert for autobrake disengagement annunciations. The PM should notify the PF anytime the autobrakes disengage.

If stopping distance is not assured with autobrakes engaged, the PF should immediately apply manual braking sufficient to assure deceleration to a safe taxi speed within the remaining runway.

A table in the PI section of the QRH shows the relative stopping capabilities of the available autobrake selections.

Transition to Manual Braking

The speed at which the transition from autobrakes to manual braking is made depends upon airplane deceleration rate, runway conditions and stopping requirements. When transitioning to manual braking, keep the speedbrakes deployed and use reverse thrust as required until taxi speed. This is especially important when nearing the end of the runway where rubber deposits affect stopping ability.

When transitioning from the autobrake system to manual braking, the PF should notify the PM. Techniques for release of autobrakes can affect passenger comfort and stopping distance. These techniques are:

- stow the speed brake handle. When stopping distance within the remaining runway is assured, this method provides a smooth transition to manual braking, is effective before or after thrust reversers are stowed, and is less dependent on manual braking technique
- smoothly apply brake pedal force as in a normal stop, until the autobrake system disarms. Following disarming of the autobrakes, smoothly release brake pedal pressure. Disarming the autobrakes before coming out of reverse thrust provides a smooth transition to manual braking
- manually position the autobrake selector off (normally done by the PM at the direction of the PF).

Manual Braking

The following technique for manual braking provides optimum braking for all runway conditions:

The pilot's seat and rudder pedals should be adjusted so that it is possible to apply maximum braking with full rudder deflection.

Immediately after main gear touchdown, smoothly apply a constant brake pedal pressure for the desired braking. For short or slippery runways, use full brake pedal pressure.

- do not attempt to modulate, pump or improve the braking by any other special techniques
- do not release the brake pedal pressure until the airplane speed has been reduced to a safe taxi speed
- the antiskid system stops the airplane for all runway conditions in a shorter distance than is possible with either antiskid off or brake pedal modulation.

737 NG Flight Crew Training Manual

The antiskid system adapts pilot applied brake pressure to runway conditions by sensing an impending skid condition and adjusting the brake pressure to each individual wheel for maximum braking effort. When brakes are applied on a slippery runway, several skid cycles occur before the antiskid system establishes the right amount of brake pressure for the most effective braking.

If the pilot modulates the brake pedals, the antiskid system is forced to readjust the brake pressure to establish optimum braking. During this readjustment time, braking efficiency is lost.

Low available braking coefficient of friction on extremely slippery runways at high speeds may be interpreted as a total antiskid failure. Pumping the brakes or turning off the antiskid degrades braking effectiveness. Maintain steadily increasing brake pressure, allowing the antiskid system to function at its optimum.

Although immediate braking is desired, manual braking techniques normally involve a four to five second delay between main gear touchdown and brake pedal application even when actual conditions reflect the need for a more rapid initiation of braking. This delayed braking can result in the loss of 800 to 1,000 feet of runway. Directional control requirements for crosswind conditions and low visibility may further increase the delays. Distractions arising from a malfunctioning reverser system can also result in delayed manual braking application.

Braking with Antiskid Inoperative

When the antiskid system is inoperative, the following techniques apply:

- ensure that the nose wheels are on the ground and the speedbrakes are extended before applying the brakes
- initiate wheel braking using very light pedal pressure and increase pressure as ground speed decreases
- apply steady pressure and DO NOT PUMP the pedals.

Flight testing has demonstrated that braking effectiveness on a wet grooved runway is similar to that of a dry runway. Caution however must be exercised when braking on any wet, ungrooved portions of the runway with antiskid inoperative to avoid blown tires.

Brake Cooling

A series of taxi-back or stop and go landings without additional in-flight brake cooling can cause excessive brake temperatures. The energy absorbed by the brakes from each landing is cumulative.

Extending the gear a few minutes early in the approach normally provides sufficient cooling for a landing. Total in-flight cooling time can be determined from the Performance Inflight section of the QRH.

The optional brake temperature monitoring system may be used for additional flight crew guidance in assessing brake energy absorption. This system indicates a stabilized value approximately fifteen minutes after brake energy absorption. Therefore, an immediate or reliable indication of tire or hydraulic fluid fire, wheel bearing problems, or wheel fracture is not available. The brake temperature monitor readings may vary between brakes during normal braking operations.

Note: Brake energy data provided in the QRH should be used to identify potential overheating situations.

To minimize brake temperature build-up:

- for airplanes without operative brake temperature monitoring systems:
If the last ground time plus present flight time is less than 90 minutes, extend the landing gear 5 minutes early or 7 minutes prior to landing
- for airplanes with operating brake temperature monitoring systems:
Extend the landing gear approximately one minute early for each unit of brake temperature above normal.

Close adherence to recommended landing roll procedures ensures minimum brake temperature build up.

Reverse Thrust Operation

Awareness of the position of the forward and reverse thrust levers must be maintained during the landing phase. Improper seat position as well as long sleeved apparel may cause inadvertent advancement of the forward thrust levers, preventing movement of the reverse thrust levers.

The position of the hand should be comfortable, permit easy access to the autothrottle disconnect switch, and allow control of all thrust levers, forward and reverse, through full range of motion.

Note: Reverse thrust always reduces the “brake only” stopping distance, brake and tire wear. Reverse thrust is most effective at high speeds.

After touchdown, with the thrust levers at idle, rapidly raise the reverse thrust levers up and aft to the interlock position, then to the number 2 reverse thrust detent. Conditions permitting, limit reverse thrust to the number 2 detent. The PM should monitor engine operating limits and call out any engine operational limits being approached or exceeded, any thrust reverser failure, or any other abnormalities.

737 NG Flight Crew Training Manual

Maintain reverse thrust as required, up to maximum, until the airspeed approaches 60 knots. At this point start reducing the reverse thrust so that the reverse thrust levers are moving down at a rate commensurate with the deceleration rate of the airplane. The thrust levers should be positioned to reverse idle by taxi speed, then to full down after the engines have decelerated to idle. The PM should call out 60 knots to assist the PF in scheduling the reverse thrust. The PM should also call out any inadvertent selection of forward thrust as reverse thrust is cancelled. If an engine surges during reverse thrust operation, quickly select reverse idle on all engines.

Reverse Thrust Operations

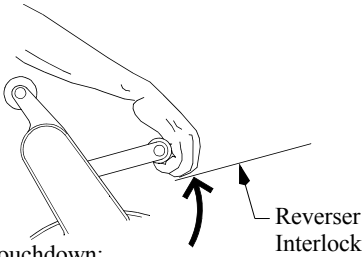

At Touchdown:
Up and aft rapidly to interlock.
Maintain light pressure on interlock.

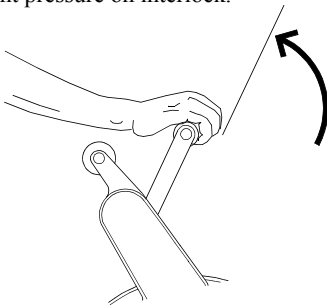
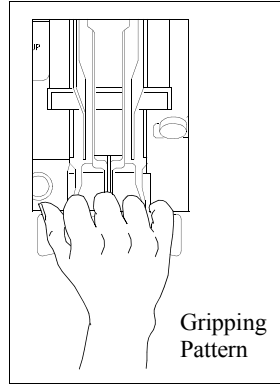

After reverser interlock release:
Apply reverse thrust as needed until 60 knots.

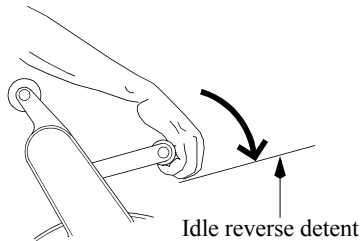

At 60 knots:
Decrease to idle reverse by taxi speed.

Reverse Thrust and Crosswind (All Engines)

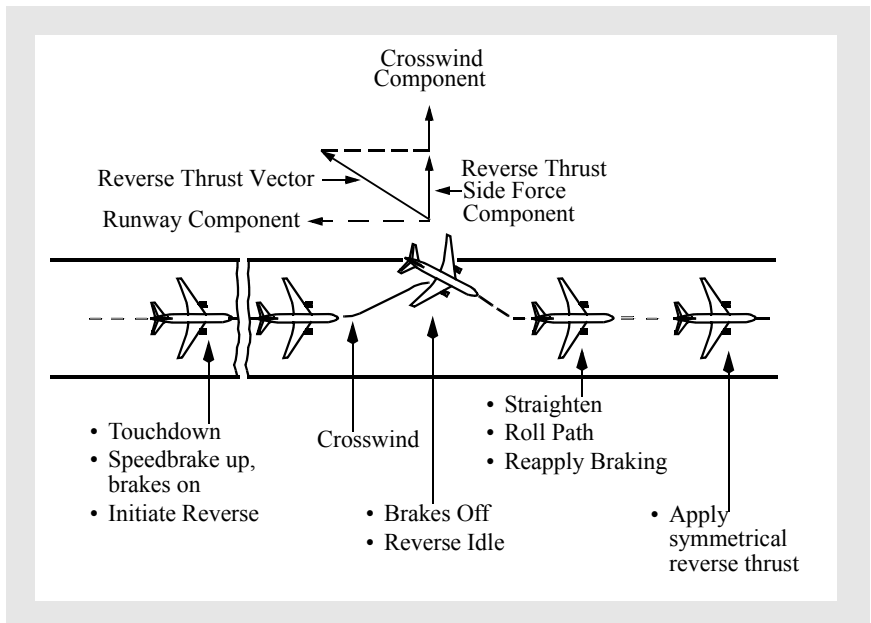

This figure shows a directional control problem during a landing rollout on a slippery runway with a crosswind. As the airplane starts to weathervane into the wind, the reverse thrust side force component adds to the crosswind component and drifts the airplane to the downwind side of the runway. Main gear tire cornering forces available to counteract this drift are at a minimum when the antiskid system is operating at maximum braking effectiveness for the existing conditions.

To correct back to the centerline, reduce reverse thrust to reverse idle and release the brakes. This minimizes the reverse thrust side force component without the requirement to go through a full reverser actuation cycle, and improve tire cornering forces for realignment with the runway centerline. Use rudder pedal steering and differential braking as required, to prevent over correcting past the runway centerline. When re-established near the runway centerline, apply maximum braking and symmetrical reverse thrust to stop the airplane.

Reverse Thrust - EEC in the Alternate Mode

Use normal reverse thrust techniques.

Reverse Thrust - Engine Inoperative

Asymmetrical reverse thrust may be used with one engine inoperative. Use normal reverse thrust procedures and techniques with the operating engine. If directional control becomes a problem during deceleration, return the thrust lever to the reverse idle detent.

Crosswind Landings

The crosswind guidelines shown below were derived through flight test data, engineering analysis and flight simulator evaluations. These crosswind guidelines are based on steady wind (no gust) conditions and include all engines operating and engine inoperative. Gust effects were evaluated and tend to increase pilot workload without significantly affecting the recommended guidelines.

Landing Crosswind Guidelines

Crosswind guidelines are not considered limitations. Crosswind guidelines are provided to assist operators in establishing their own crosswind policies.

On slippery runways, crosswind guidelines are a function of runway surface condition. These guidelines assume adverse airplane loading and proper pilot technique.

Runway Condition	Crosswind - Knots *
Dry	40 ***
Wet	40 ***
Standing Water/Slush	20
Snow - No Melting **	35 ***
Ice - No Melting **	17

Note: Reduce crosswind guidelines by 5 knots on wet or contaminated runways whenever asymmetric reverse thrust is used.

*Winds measured at 33 feet (10 m) tower height and apply for runways 148 feet (45m) or greater in width.

** Landing on untreated ice or snow should only be attempted when no melting is present.

*** Sideslip only (zero crab) landings are not recommended with crosswinds in excess of 17 knots at flaps 15, 20 knots at flaps 30, or 23 knots at flaps 40. This recommendation ensures adequate ground clearance and is based on maintaining adequate control margin.

Note: Reduce sideslip only (zero crab) landing crosswinds by 2 knots for airplanes with winglets.

Crosswind Landing Techniques

Three methods of performing crosswind landings are presented. They are the touchdown in a crab, the de-crab technique (with removal of crab in flare), and the sideslip technique. Whenever a crab is maintained during a crosswind approach, offset the flight deck on the upwind side of centerline so that the main gear touches down in the center of the runway.

De-Crab During Flare

The objective of this technique is to maintain wings level throughout the approach, flare, and touchdown. On final approach, a crab angle is established with wings level to maintain the desired track. Just prior to touchdown while flaring the airplane, downwind rudder is applied to eliminate the crab and align the airplane with the runway centerline.

As rudder is applied, the upwind wing sweeps forward developing roll. Hold wings level with simultaneous application of aileron control into the wind. The touchdown is made with cross controls and both gear touching down simultaneously. Throughout the touchdown phase upwind aileron application is utilized to keep the wings level.

Touchdown In Crab

The airplane can land using crab only (zero side slip) up to the landing crosswind guideline speeds. (See the landing crosswind guidelines table, this chapter).

On dry runways, upon touchdown the airplane tracks toward the upwind edge of the runway while de-crabbing to align with the runway. Immediate upwind aileron is needed to ensure the wings remain level while rudder is needed to track the runway centerline. The greater the amount of crab at touchdown, the larger the lateral deviation from the point of touchdown. For this reason, touchdown in a crab only condition is not recommended when landing on a dry runway in strong crosswinds.

On very slippery runways, landing the airplane using crab only reduces drift toward the downwind side at touchdown, permits rapid operation of spoilers and autobrakes because all main gears touchdown simultaneously, and may reduce pilot workload since the airplane does not have to be de-crabbed before touchdown. However, proper rudder and upwind aileron must be applied after touchdown to ensure directional control is maintained.

Sideslip (Wing Low)

The sideslip crosswind technique aligns the airplane with the extended runway centerline so that main gear touchdown occurs on the runway centerline.

The initial phase of the approach to landing is flown using the crab method to correct for drift. Prior to the flare the airplane centerline is aligned on or parallel to the runway centerline. Downwind rudder is used to align the longitudinal axis to the desired track as aileron is used to lower the wing into the wind to prevent drift. A steady sideslip is established with opposite rudder and low wing into the wind to hold the desired course.

Touchdown is accomplished with the upwind wheels touching just before the downwind wheels. Overcontrolling the roll axis must be avoided because overbanking could cause the engine nacelle or outboard wing flap to contact the runway. (See Ground Clearance Angles - Normal Landing charts, this chapter.)

Properly coordinated, this maneuver results in nearly fixed rudder and aileron control positions during the final phase of the approach, touchdown, and beginning of the landing roll. However, since turbulence is often associated with crosswinds, it is often difficult to maintain the cross control coordination through the final phase of the approach to touchdown.

If the crew elects to fly the sideslip to touchdown, it may be necessary to add a crab during strong crosswinds. (See the landing crosswind guidelines table, this chapter). Main gear touchdown is made with the upwind wing low and crab angle applied. As the upwind gear touches first, a slight increase in downwind rudder is applied to align the airplane with the runway centerline. At touchdown, increased application of upwind aileron should be applied to maintain wings level.

Overweight Landing

Overweight landings may be safely accomplished by using normal landing procedures and techniques. There are no adverse handling characteristics associated with overweight landings. Landing distance is normally less than takeoff distance for flaps 30 or 40 landings at all gross weights. However, wet or slippery runway field length requirements should be verified from the landing distance charts in the PI chapter of the QRH. Brake energy limits will not be exceeded for flaps 30 or 40 landings at all gross weights.

Note: Use of flaps 30 rather than flaps 40 is recommended to provide increased margin to flap placard speed.

If stopping distance is a concern, reduce the landing weight as much as possible. At the captain's discretion, reduce weight by holding at low altitude with a high drag configuration (gear down) to achieve maximum fuel burn-off.

Analysis has determined that, when landing at high gross weights at speeds associated with non-normal procedures requiring flaps set at 15 or less, maximum effort stops may exceed the brake energy limits. The gross weights where this condition can occur are well above maximum landing weights. For these non-normal landings, maximize use of the available runway for stopping.

737 NG Flight Crew Training Manual

Observe flap placard speeds during flap extension and on final approach. In the holding and approach patterns, maneuvers should be flown at the normal maneuver speeds. During flap extension, airspeed can be reduced by as much as 20 knots below normal maneuver speeds before extending to the next flap position. These lower speeds result in larger margins to the flap placards, while still providing normal bank angle maneuvering capability, but do not allow for a 15° overshoot margin in all cases.

Use the longest available runway, and consider wind and slope effects. Where possible avoid landing in tailwinds, on runways with negative slope, or on runways with less than normal braking conditions. Do not carry excess airspeed on final. This is especially important when landing during an engine inoperative or other non-normal condition. At weights above the maximum landing weight, the final approach maximum wind correction may be limited by the flap placards and load relief system.

Fly a normal profile. Ensure that a higher than normal rate of descent does not develop. Do not hold the airplane off waiting for a smooth landing. Fly the airplane onto the runway at the normal touchdown point. If a long landing is likely to occur, go-around. After touchdown, immediately apply maximum reverse thrust using all of the available runway for stopping to minimize brake temperatures. Do not attempt to make an early runway turnoff.

Autobrake stopping distance guidance is contained in the Performance Inflight section of the QRH. If adequate stopping distance is available based upon approach speed, runway conditions, and runway length, the recommended autobrake setting should be used.

Overweight Autolands Policy

Boeing does not recommend overweight autolands. Autopilots on Boeing airplanes are not certified for automatic landings above maximum landing weight. At higher than normal speeds and weights, the performance of these systems may not be satisfactory and has not been thoroughly tested. An automatic approach may be attempted, however the pilot should disengage the autopilot prior to flare height and accomplish a manual landing.



737 NG Flight Crew Training Manual

In an emergency, should the pilot determine that an overweight autoland is the safest course of action, the approach and landing should be closely monitored by the pilot and the following factors considered:

- touchdown may be beyond the normal touchdown zone; allow for additional landing distance.
- touchdown at higher than normal sink rates may result in exceeding structural limits.
- plan for a go-around or manual landing if autoland performance is unsatisfactory; automatic go-arounds can be initiated until just prior to touchdown, and can be continued even if the airplane touches down after initiation of the go-around.



Maneuvers

Table of Contents

Chapter 7

Section TOC

Preface 7.1

Acceleration to and Deceleration from VMO 7.1

Engine Out Familiarization 7.2

 Rudder and Lateral Control 7.2

 Thrust and Airspeed 7.3

High Altitude Maneuvering, “G” Buffet 7.4

Rapid Descent 7.5

 Autopilot Entry and Level Off 7.6

 Manual Entry and Level Off 7.7

 Landing Gear Extended Descent 7.7

 After Level Off 7.7

Stall Recovery 7.8

 Approach to Stall Recovery 7.8

 Stick Shaker and Stall Speeds 7.11

 Recovery from a Fully Developed Stall 7.20

Steep Turns 7.21

 Entry 7.21

 During Turn 7.21

 Attitude Indicator 7.21

 Vertical Speed Indicator 7.21

 Altimeter 7.21

 Airspeed 7.22

 Rollout 7.22



Terrain Avoidance	7.22
Traffic Alert and Collision Avoidance System (TCAS)	7.22
Use of TA/RA, TA Only, and Transponder Only Modes	7.22
Traffic Advisory (TA)	7.23
Resolution Advisory (RA)	7.23
Upset Recovery	7.24
General	7.24
Upset Recovery Techniques	7.28
Windshear	7.28
General	7.28
Airplane Performance in Windshear	7.28
Avoidance, Precautions and Recovery	7.29

Preface

This chapter outlines the recommended operating practices and techniques used during maneuvers in both the training and operational environment. The flight profile illustrations represent the Boeing recommended basic configuration during the accomplishment of the flight maneuvers, and provides a basis for standardization and crew coordination.

Maneuvering for events such as Approach to Stall Recovery, Terrain Avoidance, Traffic Avoidance, Upset Recovery, or Windshear may result in deviation from the ATC clearance. The crew should expeditiously return to the applicable ATC clearance immediately following such maneuvering unless otherwise directed.

Acceleration to and Deceleration from VMO

Acceleration to and deceleration from VMO demonstrates performance capabilities and response to speed, thrust, and configuration changes throughout the medium altitude speed range of the airplane. This maneuver is performed in the full flight simulator and is for demonstration purposes only. It is normally performed at 10,000 to 15,000 feet, simulating slowdown to 250 knots due to speed restrictions.

VMO is a structural limitation and is the maximum operating indicated airspeed. It is a constant airspeed from sea level to the altitude where VMO and MMO coincide. MMO is the structural limitation above this altitude. Sufficient thrust is available to exceed VMO in level flight at lower altitudes. Failure to reduce to cruise thrust in level flight can result in excessive airspeed.

Begin the maneuver at existing cruise speed with the autothrottle connected and the autopilot disconnected. Set command speed to VMO. As speed increases observe:

- nose down trim required to keep airplane in trim and maintain level flight
- handling qualities during acceleration
- autothrottle protection at VMO.

At a stabilized speed just below VMO execute turns at high speed while maintaining altitude. Next, accelerate above VMO by disconnecting the autothrottle and increasing thrust.

When the overspeed warning occurs reduce thrust levers to idle, set command speed to 250 knots, and decelerate to command speed. Since the airplane is aerodynamically clean, any residual thrust results in a longer deceleration time. As airspeed decreases observe that nose up trim is required to keep airplane in trim and maintain level flight. During deceleration note the distance traveled from the time the overspeed warning stops until reaching 250 knots.



Once stabilized at 250 knots, set command speed to flaps up maneuvering speed and decelerate to command speed, again noting the distance traveled during deceleration. Observe the handling qualities of the airplane during deceleration.

This maneuver may be repeated using speedbrakes to compare deceleration times and distances.

Engine Out Familiarization

The exercises shown in the following table are performed to develop proficiency in handling the airplane with one engine inoperative and gain familiarization with rudder control requirements.

	Condition One	Condition Two
Airspeed	Flaps up maneuvering speed	V ₂
Landing Gear	Up	Down
Flaps	Up	15
Thrust	As Required	MCT
When In Trim - Retard one thrust lever to idle Controls - Apply to maintain heading, wings level Rudder - Apply to center control wheel Airspeed - Maintain with thrust (Condition One) Pitch (Condition Two) Trim - As required to relieve control forces		

One engine out controllability is excellent during takeoff roll and after lift-off.

Minimum control speed in the air is below VR and VREF.

Rudder and Lateral Control

This familiarization is performed to develop proficiency in handling the airplane with an engine inoperative. It also helps to gain insight into rudder control requirements.

Under instrument conditions the instrument scan is centered around the attitude indicator. Roll is usually the first indication of an asymmetric condition. Roll control (ailerons) should be used to hold the wings level or maintain the desired bank angle. Stop the yaw by smoothly applying rudder at the same rate that thrust changes. When the rudder input is correct, very little control wheel displacement is necessary. Refine the rudder input as required and trim the rudder so the control wheel remains approximately level.

737 NG Flight Crew Training Manual

When the rudder is trimmed to level the control wheel, the airplane maintains heading. A small amount of bank toward the operating engine may be noticeable on the bank indicator. The slip/skid indicator is displaced slightly toward the operating engine.

If the airplane is trimmed with too much control wheel displacement, full lateral control is not available and spoilers on one wing may be raised, increasing drag.

Make turns at a constant airspeed and hold the rudder displacement constant. Do not attempt to coordinate rudder and lateral control in turns. Rudder pedal inputs produce roll due to yaw and induce the pilot to counter rudder oscillations with opposite control wheel.

The following figure shows correct and incorrect use of the rudder.

If an engine failure occurs with the autopilot engaged, manually position the rudder to approximately center the control wheel and add thrust. Trim the rudder to relieve rudder pedal pressure.

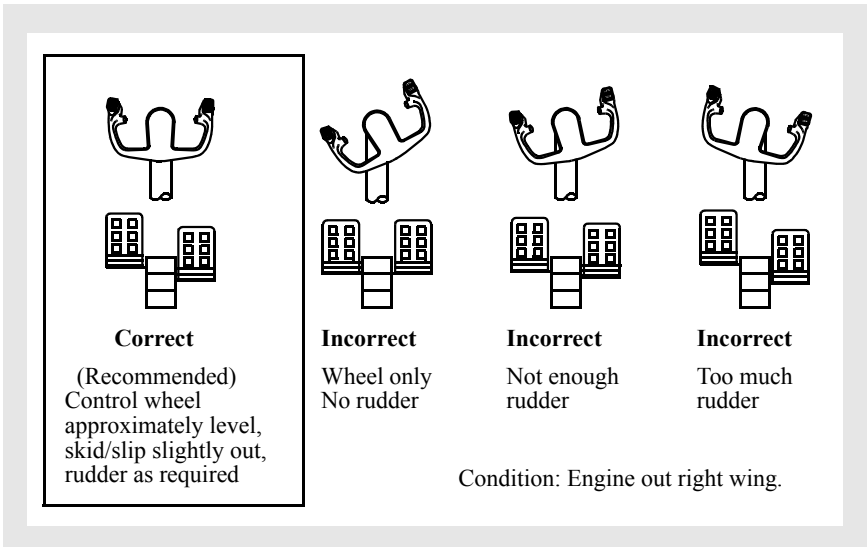

Thrust and Airspeed

If not thrust limited, apply additional thrust, if required, to control the airspeed. The total two engine fuel flow existing at the time of engine failure may be used initially to establish a thrust setting at low altitude. If performance limited (high altitude), adjust airplane attitude to maintain airspeed while setting maximum continuous thrust.

Note: Autothrottle should not be used with an engine inoperative.



High Altitude Maneuvering, “G” Buffet

Airplane buffet reached as a result of airplane maneuvering is commonly referred to as “g” buffet. During turbulent flight conditions, it is possible to experience high altitude “g” buffet at speeds less than MMO. In training, buffet is induced to demonstrate the airplane’s response to control inputs during flight in buffet.

Establish an airspeed of 0.80M. Induce “g” buffet by smoothly increasing the bank angle until the buffet is noticeable. Increase the rate of descent while increasing the bank angle to maintain airspeed. Do not exceed 45° of bank. If buffet does not occur by 45° of bank, increase control column back pressure until buffet occurs. When buffet is felt, relax back pressure and smoothly roll out to straight and level. Notice that the controls are fully effective at all times.

Rapid Descent

This section addresses basic techniques and procedures for a rapid descent. Some routes over mountainous terrain require careful operator planning to include carrying additional oxygen, special procedures, higher initial level off altitudes, and emergency routes in the event a depressurization is experienced. These requirements are normally addressed in an approved company route manual or other document that addresses route specific depressurization procedures.

This maneuver is designed to bring the airplane down smoothly to a safe altitude, in the minimum time, with the least possible passenger discomfort.

Note: Use of the autopilot is recommended.

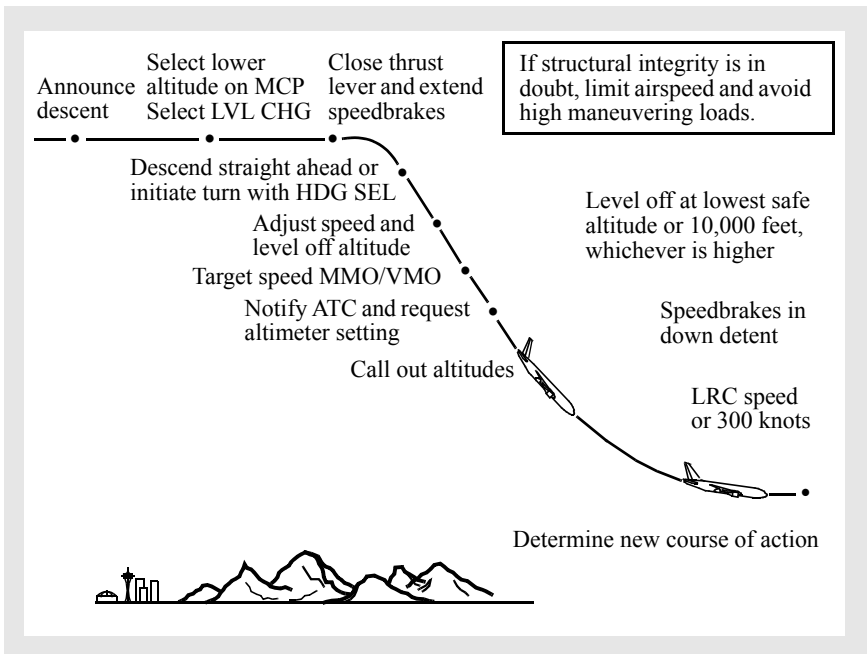

If the descent is performed because of a rapid loss of cabin pressure, crewmembers should place oxygen masks on and establish communication at the first indication of a loss of cabin pressurization. Verify cabin pressure is uncontrollable, and if so begin descent. If structural damage exists or is suspected, limit airspeed to current speed or less. Avoid high maneuvering loads.

Perform the procedure deliberately and methodically. Do not be distracted from flying the airplane. If icing conditions are entered, use anti-ice and thrust as required.

Note: Rapid descents are normally made with the landing gear up.

The PM checks the lowest safe altitude, notifies ATC, and obtains an altimeter setting (QNH). Both pilots should verify that all recall items have been accomplished and call out any items not completed. The PM calls out 2,000 feet and 1,000 feet above the level off altitude.

Level off at the lowest safe altitude or 10,000 feet, whichever is higher. Lowest safe altitude is the Minimum Enroute Altitude (MEA), Minimum Off Route Altitude (MORA), or any other altitude based on terrain clearance, navigation aid reception, or other appropriate criteria.

If severe turbulent air is encountered or expected, reduce to the turbulent air penetration speed.

Autopilot Entry and Level Off

Level Change (LVL CHG)

Because of airspeed and altitude protection and reduced crew workload, use of the autopilot with LVL CHG mode is the recommended technique for rapid descents. Use of the V/S mode is not recommended.

First set a lower altitude in the altitude window. Select LVL CHG, close the thrust levers and smoothly extend the speedbrakes. Fly straight ahead or initiate a turn using HDG SEL. Autothrottles should be left engaged. The airplane pitches down smoothly while the thrust levers retard to idle. Adjust the speed as needed and ensure the altitude window is correctly set for the level off. During descent, the IAS/MACH speed window changes from MACH to IAS at approximately 300 KIAS. Manually reset to VMO as needed.

When approaching the target altitude, ensure the altitude is set in the MCP altitude select window. Altitude capture engages automatically. Adjusting the command speed to approximately LRC or 300 knots before level-off aids in smoothly transitioning to level flight. The pitch mode then controls altitude and the thrust levers increase to hold speed. Smoothly return the speedbrake lever to the down detent during the level off maneuver.

When descending with the autopilot engaged and the speedbrakes extended at speeds near VMO/MMO, the airspeed may momentarily increase to above VMO/MMO if the speedbrakes are retracted quickly. To avoid this condition, smoothly and slowly retract the speedbrakes to allow the autopilot sufficient time to adjust the pitch attitude to maintain the airspeed within limits.

When the speedbrakes are retracted during altitude capture near VMO/MMO, a momentary overspeed condition may also occur. This is because the autopilot captures the selected altitude smoothly by maintaining a fixed path while the thrust is at or near idle. To avoid this condition, it may be necessary to reduce the selected speed and/or descent rate before altitude capture or reduce the selected speed and delay speedbrake retraction until after level off is complete.

737 NG Flight Crew Training Manual

Control Wheel Steering (CWS)

CWS may be used to reduce pilot workload. Follow the manually flown procedure but instead of disengaging the autopilot, engage CWS.

Manual Entry and Level Off

The entry may be accomplished on heading or a turn may be made to clear the airway or controlled track. However, since extending the speedbrakes initially reduces the maneuver margin, it is recommended that turns not be initiated until the airplane is established in the descent.

To manually fly the maneuver, disconnect the autothrottles and retard thrust levers to idle. Smoothly extend the speedbrakes, disconnect the autopilot and smoothly lower the nose to initial descent attitude (approximately 10 degrees nose down).

About 10 knots before reaching target speed, slowly raise the pitch attitude to maintain target speed. Keep the airplane in trim at all times. If MMO/VMO is inadvertently exceeded, change pitch smoothly to decrease speed.

Approaching level off altitude, smoothly adjust pitch attitude to reduce rate of descent. The speedbrake lever should be returned to the down detent when approaching the desired level off altitude. After reaching level flight add thrust to maintain long range cruise or 300 knots.

Landing Gear Extended Descent

The rapid descent is normally made with the landing gear up. However, when structural integrity is in doubt and airspeed must be limited, extension of the landing gear may provide a more satisfactory rate of descent.

If the landing gear is to be used during the descent, comply with the landing gear placard speeds.

After Level Off

Recheck the pressurization system and evaluate the situation. Do not remove the crew oxygen masks if cabin altitude remains above 10,000 feet. Determine the new course of action based on weather, oxygen, fuel remaining, medical condition of crew and passengers, and available airports. Obtain a new ATC clearance.

Stall Recovery

The objective of the approach to stall recovery maneuver is to familiarize the pilot with the stall warning and correct recovery techniques. Recovery from a fully developed stall is discussed later in this section.

Approach to Stall Recovery

The following discussion and maneuvers are for an approach to a stall as opposed to a fully developed stall. An approach to a stall is a controlled flight maneuver; a stall is an out-of-control, but recoverable, condition.

Approach to Stall Recovery

Initial Conditions			Approach	Recovery
Flaps	Gear	Bank	Target% N1*	If ground contact is not a factor At buffet or stick shaker: <ul style="list-style-type: none"> • Apply maximum thrust • Smoothly decrease pitch attitude to approximately 5° above the horizon • Level wings • Accelerate to maneuvering speed for flap position • Stop descent and return to target altitude • At altitudes above 20,000 feet, pitch attitudes less than 5° may be necessary to achieve acceptable acceleration.
Up	Up	0°	35 - 45%	
15	Dn	25°	60 - 70%	
30	Dn	0°	60 - 70%	
			*Approximate power settings to achieve a 1 kt/sec deceleration	If ground contact is a factor At buffet or stick shaker: <ul style="list-style-type: none"> • Apply maximum thrust • Smoothly adjust attitude as needed to avoid terrain • Level wings • Accelerate to maneuvering speed for flap position • Level off at target altitude.
<p>Maintain airplane in trim until stick shaker or buffet</p>			<p>Note pitch attitude at trim speed</p>	
			<p>Maneuver complete</p>	

Command Speed

As the airplane is decelerated to the desired initial condition for the approach to stall, set command speed to the maneuver speed for each selected flap setting. For the approach to stall in the landing configuration, set command speed to VREF 30 + 5 knots.

Initial Buffet-Stall Warning-Stall Buffet

The approach to stall recovery maneuver is entered with thrust that achieves an airspeed decrease of approximately 1 knot per second.

During the initial stages of a stall, local airflow separation results in initial buffet giving natural warning of an approach to stall. A stall warning is considered to be any warning readily identifiable by the pilot, either artificial (stick shaker) or initial buffet. Recovery from an approach to stall is initiated at the earliest recognizable stall warning, initial buffet or stick shaker.

Lateral and Directional Control

Lateral control is maintained with ailerons. Rudder control should not be used because it causes yaw and the resultant roll is undesirable.

Effect of Flaps

Flaps are used to increase low speed performance capability. The leading edge devices ensure that the inboard wing stalls before the outboard wing. This causes the nose of the airplane to pitch down at the onset of the stall.

Effect of Speedbrakes

For any airspeed, the angle of attack is higher with speedbrakes up. This increases initial buffet speed and stick shaker speed but has a lesser effect on actual stall speed.

Entry

To save time, thrust levers may be closed to allow a more rapid deceleration. Target thrust for the configuration should be set approaching selected speed.

Some thrust is used during entry to provide positive engine acceleration for the recovery. The airplane is maintained in trim while decelerating. Level flight or a slight rate of climb is desired.

Landing Gear

If the entry has been made with the landing gear extended, do not retract it until after the recovery.

Flaps

Do not retract flaps during the recovery. Retracting the flaps from the landing position, especially when near the ground, causes an altitude loss during the recovery.

Recovery

Recover from approach to a stall with one of the following recommended recovery techniques.

Ground Contact Not a Factor

At the first indication of stall (buffet or stick shaker) smoothly apply maximum thrust, smoothly decrease the pitch attitude to approximately 5 degrees above the horizon and level the wings. As the engines accelerate, counteract the nose up pitch tendency with positive forward control column pressure and nose down trim. (At altitudes above 20,000 feet, pitch attitudes of less than 5 degrees may be necessary to achieve acceptable acceleration.)

Accelerate to maneuvering speed and stop the rate of descent. Correct back to the target altitude.

Ground Contact a Factor

At the first indication of stall (buffet or stick-shaker) smoothly advance the thrust levers to maximum thrust and adjust the pitch attitude as needed to avoid the ground. Simultaneously level the wings. Control pitch as smoothly as possible. As the engines accelerate, the airplane nose pitches up. To assist in pitch control, add more nose down trim as the thrust increases. Avoid abrupt control inputs that may induce a secondary stall. Use intermittent stick shaker as the upper limit for pitch attitude for recovery when ground contact is a factor.

When ground contact is no longer a factor, continue to adjust pitch as required to maintain level flight or a slight climb while accelerating to maneuvering speed for the existing flap position.

Autopilot Engaged

If an approach to a stall is encountered with the autopilot engaged, apply limit thrust and allow the airplane to return to the normal speed. At high altitude, it may be necessary to initiate a descent to regain maneuvering speed. If autopilot response is not acceptable, it should be disengaged.

Stick Shaker and Stall Speeds

The following figures depict stick shaker and stall speeds at various gross weights and flap settings. This data is presented for training purposes only.



Stick Shaker and Stall Speeds

737-600

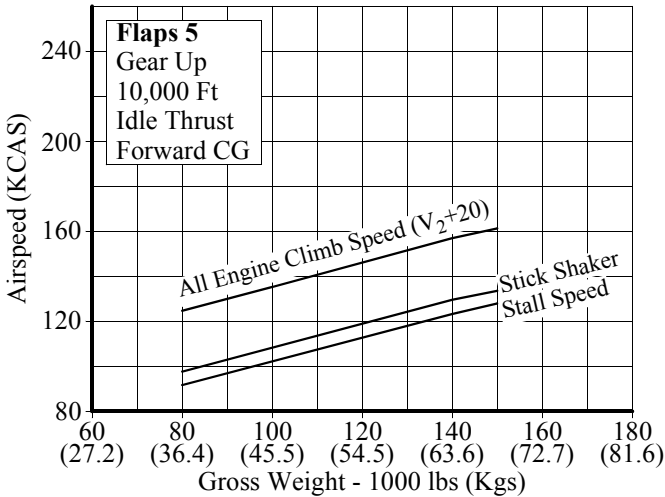
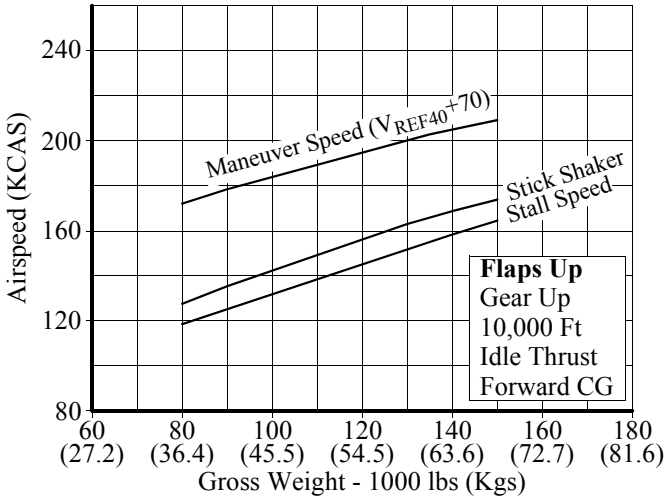

737 NG Flight Crew Training Manual

Stick Shaker and Stall Speeds

737-600

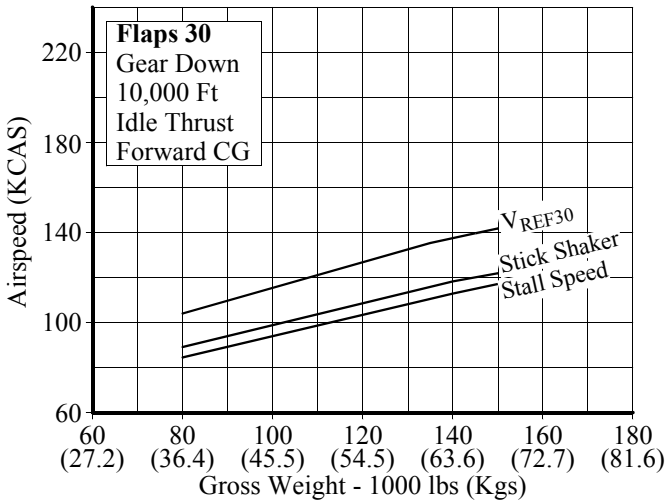
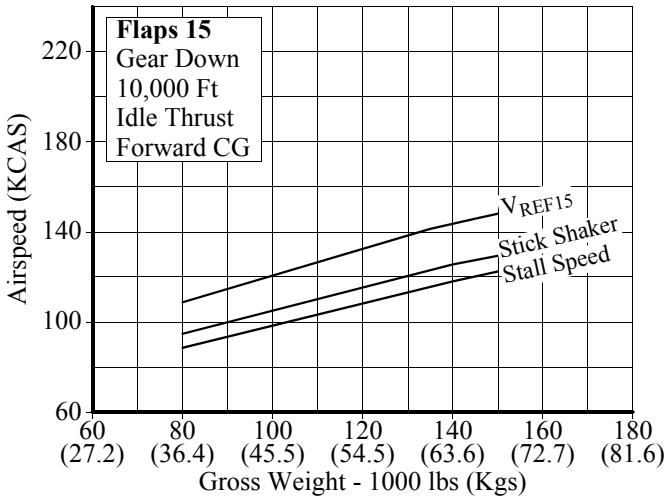



737 NG Flight Crew Training Manual

Stick Shaker and Stall Speeds

737-700

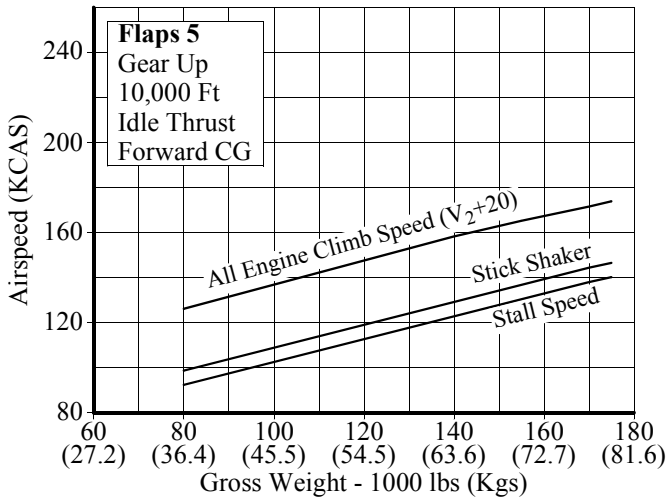
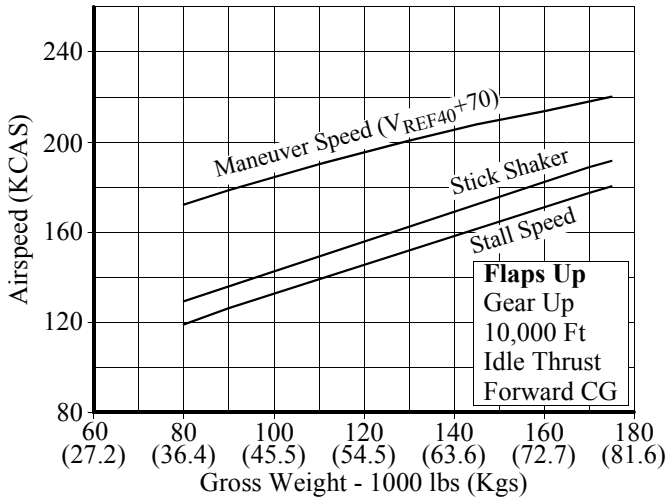

737 NG Flight Crew Training Manual

Stick Shaker and Stall Speeds

737-700

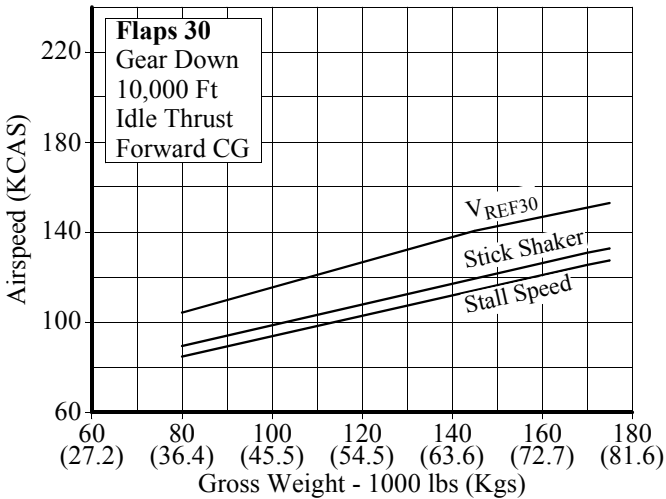
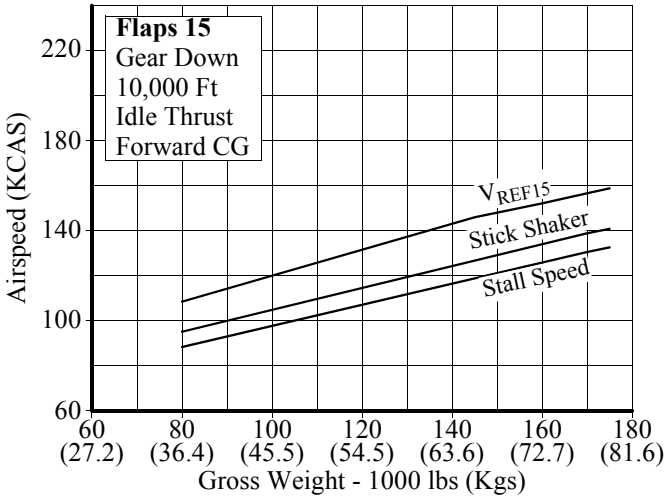



Stick Shaker and Stall Speeds

737-800

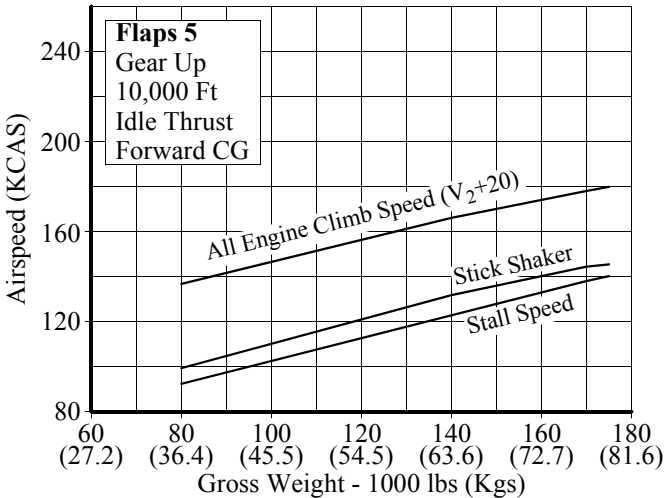
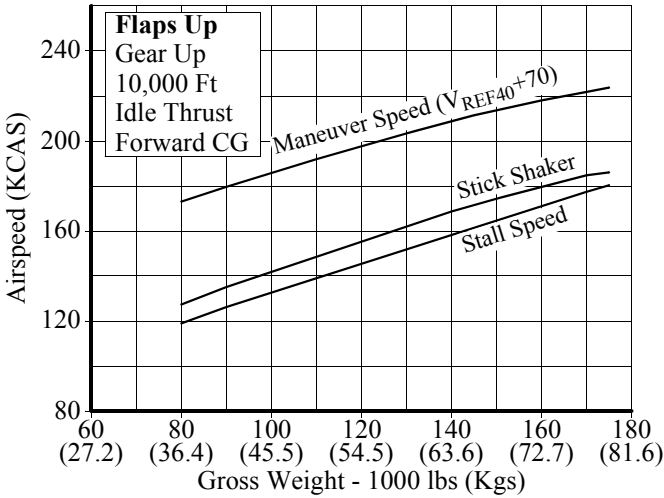

737 NG Flight Crew Training Manual

Stick Shaker and Stall Speeds

737-800

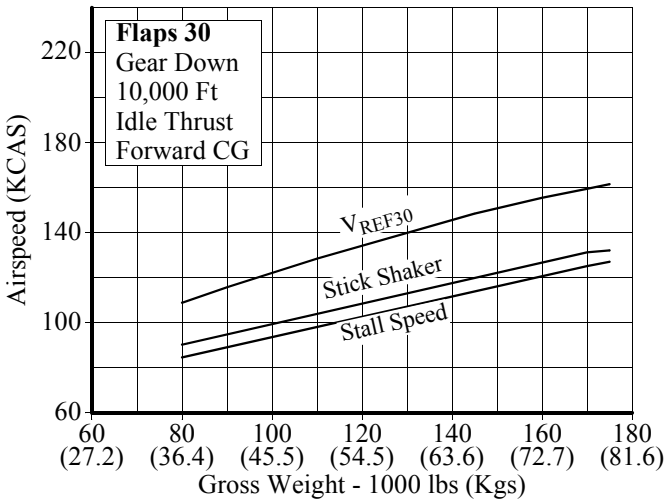
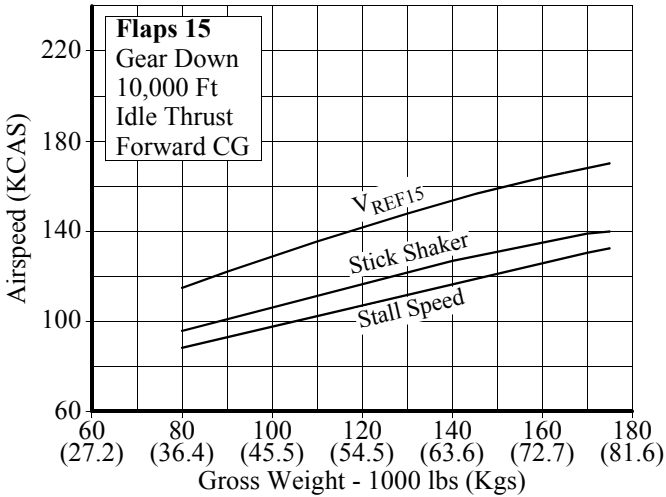



Stick Shaker and Stall Speeds

737-900

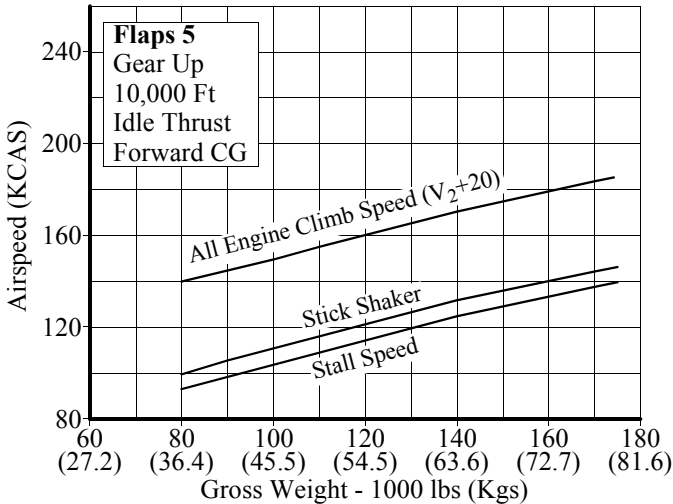
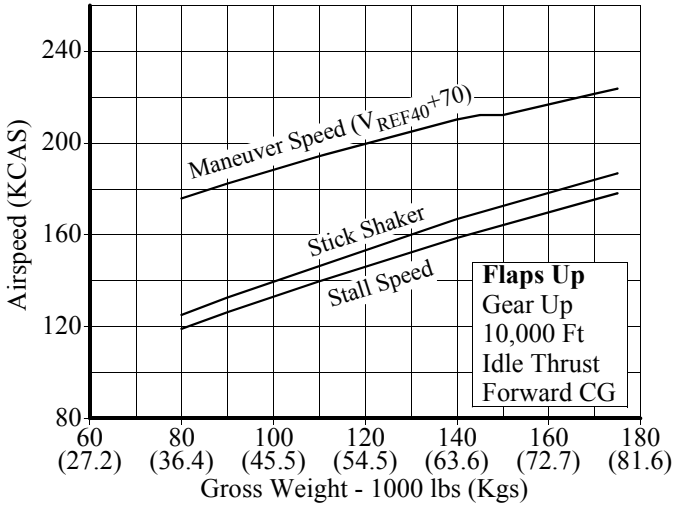

737 NG Flight Crew Training Manual

Stick Shaker and Stall Speeds

737-900

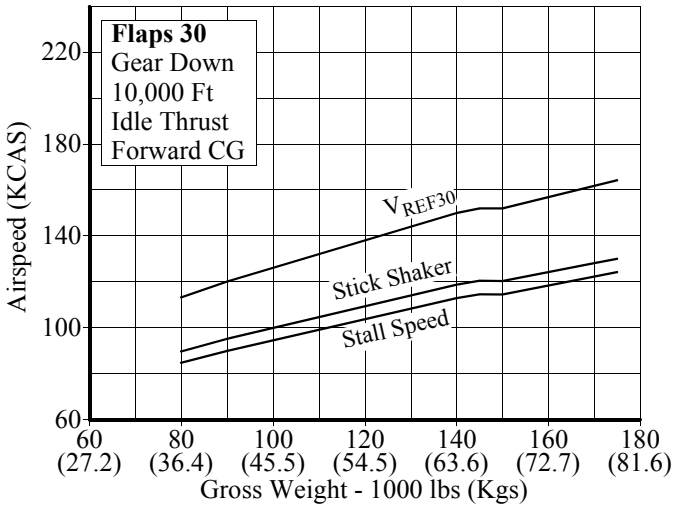
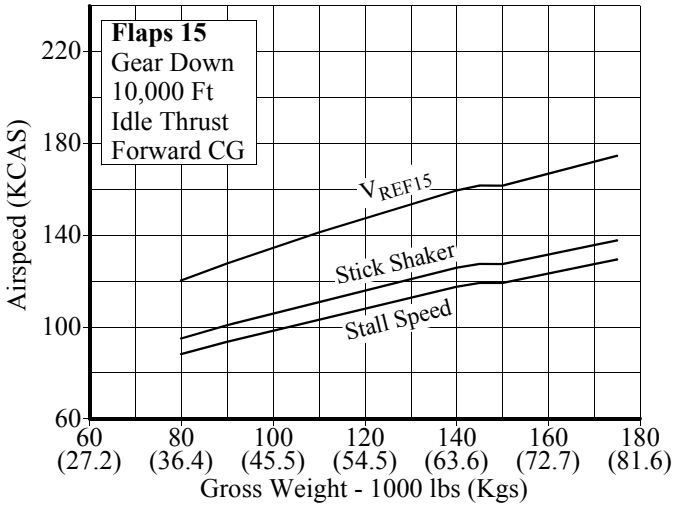

Recovery from a Fully Developed Stall

An airplane may be stalled in any attitude (nose high, nose low, high angle of bank) or any airspeed (turning, accelerated stall). It is not always intuitively obvious that the airplane is stalled.

An airplane stall is characterized by any one (or a combination) of the following conditions:

- buffeting, which could be heavy
- lack of pitch authority
- lack of roll control
- inability to arrest descent rate.

These conditions are usually accompanied by a continuous stall warning. A stall must not be confused with the stall warning that alerts the pilot to an approaching stall. Recovery from an approach to a stall is not the same as recovery from an actual stall. An approach to a stall is a controlled flight maneuver; a stall is an out-of-control, but recoverable, condition.

Note: Anytime the airplane enters a fully developed stall, the autopilot and autothrottle should be disconnected.

To recover from a stall, angle of attack must be reduced below the stalling angle. Nose down pitch control must be applied and maintained until the wings are unstalled. Application of forward control column (as much as full forward may be required) and the use of some nose-down stabilizer trim should provide sufficient elevator control to produce a nose-down pitch rate. It may be difficult to know how much stabilizer trim to use, and care must be taken to avoid using too much trim. Pilots should not fly the airplane using stabilizer trim, and should stop trimming nose down when they feel the g force on the airplane lessen or the required elevator force lessen.

Under certain conditions, on airplanes with underwing-mounted engines, it may be necessary to reduce thrust in order to prevent the angle of attack from continuing to increase. Once the wing is unstalled, upset recovery actions may be taken and thrust reapplied as needed.

If normal pitch control inputs do not stop an increasing pitch rate in a nose high situation, rolling the airplane to a bank angle that starts the nose down may be effective. Bank angles of about 45°, up to a maximum of 60°, could be needed. Normal roll controls - up to full deflection of ailerons and spoilers - may be used. Unloading the wing by maintaining continuous nose-down elevator pressure keeps the wing angle of attack as low as possible, making the normal roll controls as effective as possible.

737 NG Flight Crew Training Manual

Finally, if normal pitch control then roll control is ineffective, careful rudder input in the direction of the desired roll may be required to initiate a rolling maneuver recovery.

WARNING: Only a small amount of rudder is needed. Too much rudder applied too quickly or held too long may result in loss of lateral and directional control.

Steep Turns

The objective of the steep turn maneuver is to familiarize the pilot with airplane handling characteristics beyond 35° of bank and improve the instrument cross check. During training, 45° of bank is used for this maneuver. It is not intended that the pilot should ever be required to bank greater than 25° to 30° in any normal or non-normal condition.

Note: Stabilizer trim is not recommended during the steep turn maneuver because of increased workload during roll out.

Entry

Stabilize airspeed at 250 knots on heading and altitude. Use a normal turn entry. An increase in pitch is required as the bank angle is increased to maintain constant altitude. An increase in thrust is required to maintain constant airspeed.

During Turn

Pitch and thrust control are the same as for a normal turn; however, larger pitch adjustments are required for a given altitude deviation. Trimming during the maneuver is not recommended. Varying the angle of bank while turning makes pitch control more difficult. If altitude loss becomes excessive, reduce the angle of bank as needed to regain positive pitch control.

Smooth and positive control is required. A rapid instrument scan is required to detect deviations early enough to be corrected by small adjustments.

Attitude Indicator

The attitude indicator is reliable for accurate pitch and bank information throughout the turn. Precession error does not exist because the IRS is the source of attitude information.

Vertical Speed Indicator

IRS vertical speed indications are reliable during the turn.

Altimeter

Crosscheck the direction and rate of change, and make smooth minor adjustments to the pitch attitude for corrections.

Airspeed

Airspeed changes very slowly because of small changes in thrust and drag. Anticipate thrust changes and apply them at the first indication of change on the airspeed indicator or speed tape (as installed). An increase in thrust is required as bank angle increases.

Rollout

Roll out at the same rate as used during normal turns. Normally rollout should begin 15° to 20° prior to the desired heading. A decrease in pitch is required as the bank angle is decreased to maintain constant altitude. A decrease in thrust is required to maintain constant airspeed.

Terrain Avoidance

The Ground Proximity Warning System (GPWS) PULL UP Warning occurs when an unsafe distance or closure rate is detected with terrain below the airplane. The Look-ahead terrain alerting (as installed) also provides an aural warning when an unsafe distance is detected from terrain ahead of the airplane. Immediately accomplish the Terrain Avoidance maneuver found in the non-normal maneuvers section in the QRH.

Do not attempt to engage the autopilot and/or autothrottle until terrain clearance is assured.

Traffic Alert and Collision Avoidance System (TCAS)

TCAS is designed to enhance crew awareness of nearby traffic and issue advisories for timely visual acquisition or appropriate vertical flight path maneuvers to avoid potential collisions. It is intended as a backup to visual collision avoidance, application of right-of-way rules and ATC separation.

Use of TA/RA, TA Only, and Transponder Only Modes

TCAS operation should be initiated just before takeoff and continued until just after landing. Whenever practical, the system should be operated in the TA/RA mode to maximize system benefits. Operations in the Traffic Advisory (TA) Only or TCAS Off (Transponder Only) modes, to prevent nuisance advisories and display clutter, should be in accordance with operator policy.

The responsibility for avoiding collisions still remains with the flight crew and ATC. Pilots should not become preoccupied with TCAS advisories and displays at the expense of basic airplane control, normal visual lookout and other crew duties.

Traffic Advisory (TA)

A Traffic Advisory (TA) occurs when nearby traffic meets system minimum separation criteria, and is indicated aurally and visually on the TCAS traffic display. A goal of the TA is to alert the pilot of the possibility of an RA. If a TA is received, immediately accomplish the Traffic Avoidance maneuver in the QRH.

Maneuvers based solely on a TA may result in reduced separation and are not recommended.

The TA ONLY mode may be appropriate under the following circumstances:

- during takeoff toward known nearby traffic (in visual contact) which would cause an unwanted RA during initial climb
- during closely spaced parallel runway approaches
- when flying in known close proximity to other airplanes
- in circumstances identified by the operator as having a verified and significant potential for unwanted or undesirable RAs
- engine out operation.

Resolution Advisory (RA)

When TCAS determines that separation from approaching traffic may not be sufficient, TCAS issues a Resolution Advisory (RA) aural warning and a pitch command. Maneuvering is required if any portion of the airplane symbol is within the red region on the attitude indicator. Flight crews should follow RA commands using established procedures unless doing so would jeopardize the safe operation of the airplane or positive visual contact confirms that there is a safer course of action. If a RA is received, immediately accomplish the Traffic Avoidance maneuver in the QRH.

Resolution advisories are known to occur more frequently at locations where traffic frequently converges (e.g. waypoints). This is especially true in RVSM airspace. Climb or descent profiles should not be modified in anticipation of avoiding an RA unless specifically requested by ATC.

RA maneuvers require only small pitch attitude changes which should be accomplished smoothly and without delay. Properly executed, the RA maneuver is mild and does not require large or abrupt control movements. Remember that the passengers and flight attendants may not all be seated during this maneuver. The flight director is not affected by TCAS guidance. Therefore, when complying with an RA, flight director commands may be followed only if they result in a vertical speed that satisfies the RA command.

During the RA maneuver, the aircrew attempts to establish visual contact with the target. However, visual perception of the encounter can be misleading, particularly at night. The traffic acquired visually may not be the same traffic causing the RA.

Pilots should maintain situational awareness since TCAS may issue RAs in conflict with terrain considerations, such as during approaches into rising terrain or during an obstacle limited climb. Continue to follow the planned lateral flight path unless visual contact with the conflicting traffic requires other action. Windshear, GPWS, and stall warnings take precedence over TCAS advisories. Stick shaker must be respected at all times. Complying with RAs may result in brief exceedance of altitude and/or placard limits. However, even at the limits of the operating envelope, in most cases sufficient performance is available to safely maneuver the airplane. Smoothly and expeditiously return to appropriate altitudes and speeds when clear of conflict. Maneuvering opposite to an RA command is not recommended since TCAS may be coordinating maneuvers with other airplanes.

Upset Recovery

For detailed information regarding the nature of upsets, aerodynamic principles, recommended training and other related information, refer to the Airplane Upset Recovery Training Aid available through your operator.

An upset can generally be defined as unintentionally exceeding the following conditions:

- pitch attitude greater than 25 degrees nose up, or
- pitch attitude greater than 10 degrees nose down, or
- bank angle greater than 45 degrees, or
- within above parameters but flying at airspeeds inappropriate for the conditions.

General

Though flight crews in line operation rarely, if ever, encounter an upset situation, understanding how to apply aerodynamic fundamentals in such a situation helps them control the airplane. Several techniques are available for recovering from an upset. In most situations, if a technique is effective, it is not recommended that pilots use additional techniques. Several of these techniques are discussed in the example scenarios below:

- stall recovery
- nose high, wings level
- nose low, wings level
- high bank angles
- nose high, high bank angles
- nose low, high bank angles

Stall Recovery

In all upset situations, it is necessary to recover from a stall before applying any other recovery actions. A stall may exist at any attitude and may be recognized by continuous stick shaker activation accompanied by one or more of the following:

- buffeting which could be heavy at times
- lack of pitch authority and/or roll control
- inability to arrest descent rate.

If the airplane is stalled, recovery from the stall must be accomplished first by applying and maintaining nose down elevator until stall recovery is complete and stick shaker activation ceases. Under certain conditions, it may be necessary to reduce some thrust in order to prevent the angle of attack from continuing to increase. Once stall recovery is complete, upset recovery actions may be taken and thrust reapplied as needed.

Nose High, Wings Level

In a situation where the airplane pitch attitude is unintentionally more than 25 degrees nose high and increasing, the airspeed is decreasing rapidly. As airspeed decreases, the pilot's ability to maneuver the airplane also decreases. If the stabilizer trim setting is nose up, as for slow-speed flight, it partially reduces the nose-down authority of the elevator. Further complicating this situation, as the airspeed decreases, the pilot could intuitively make a large thrust increase. This causes an additional pitch up. At full thrust settings and very low airspeeds, the elevator, working in opposition to the stabilizer, has limited control to reduce the pitch attitude.

In this situation the pilot should trade altitude for airspeed, and maneuver the airplane's flight path back toward the horizon. This is accomplished by the input of up to full nose-down elevator and the use of some nose-down stabilizer trim. These actions should provide sufficient elevator control power to produce a nose-down pitch rate. It may be difficult to know how much stabilizer trim to use, and care must be taken to avoid using too much trim. Pilots should not fly the airplane using stabilizer trim, and should stop trimming nose down when they feel the g force on the airplane lessen or the required elevator force lessen. This use of stabilizer trim may correct an out-of-trim airplane and solve a less-critical problem before the pilot must apply further recovery measures. Because a large nose-down pitch rate results in a condition of less than 1 g, at this point the pitch rate should be controlled by modifying control inputs to maintain between 0 to 1 g. If altitude permits, flight tests have determined that an effective way to achieve a nose-down pitch rate is to reduce some thrust.

If normal pitch control inputs do not stop an increasing pitch rate, rolling the airplane to a bank angle that starts the nose down should work. Bank angles of about 45 degrees, up to a maximum of 60 degrees, could be needed. Unloading the wing by maintaining continuous nose-down elevator pressure keeps the wing angle of attack as low as possible, making the normal roll controls as effective as possible. With airspeed as low as stick shaker onset, normal roll controls - up to full deflection of ailerons and spoilers - may be used. The rolling maneuver changes the pitch rate into a turning maneuver, allowing the pitch to decrease. Finally, if normal pitch control then roll control is ineffective, careful rudder input in the direction of the desired roll may be required to induce a rolling maneuver for recovery.

Only a small amount of rudder is needed. Too much rudder applied too quickly or held too long may result in loss of lateral and directional control. Because of the low energy condition, pilots should exercise caution when applying rudder.

The reduced pitch attitude allows airspeed to increase, thereby improving elevator and aileron control effectiveness. After the pitch attitude and airspeed return to a desired range the pilot can reduce angle of bank with normal lateral flight controls and return the airplane to normal flight.

Nose Low, Wings Level

In a situation where the airplane pitch attitude is unintentionally more than 10 degrees nose low and going lower, the airspeed is increasing rapidly. A pilot would likely reduce thrust and extend the speedbrakes. Thrust reduction causes an additional nose-down pitching moment. Speedbrake extension causes a nose-up pitching moment, an increase in drag, and a decrease in lift for the same angle of attack. At airspeeds well above VMO/MMO, the ability to command a nose-up pitch rate with elevator may be reduced because of the extreme aerodynamic loads on the elevator.

Again, it is necessary to maneuver the airplane's flight path back toward the horizon. At moderate pitch attitudes, applying nose-up elevator, reducing thrust, and extending speedbrakes, if necessary, changes the pitch attitude to a desired range. At extremely low pitch attitudes and high airspeeds (well above VMO/MMO), nose-up elevator and nose-up trim may be required to establish a nose-up pitch rate.

High Bank Angles

A high bank angle is one beyond that necessary for normal flight. Though the bank angle for an upset has been defined as unintentionally more than 45 degrees, it is possible to experience bank angles greater than 90 degrees.

737 NG Flight Crew Training Manual

Any time the airplane is not in “zero-angle-of-bank” flight, lift created by the wings is not being fully applied against gravity, and more than 1 g is required for level flight. At bank angles greater than 67 degrees, level flight cannot be maintained within AFM load factor limits. In high bank angle increasing airspeed situations, the primary objective is to maneuver the lift of the airplane to directly oppose the force of gravity by rolling (in the shortest direction) to wings level. Applying nose-up elevator at bank angles above 60 degrees causes no appreciable change in pitch attitude and may exceed normal structure load limits as well as the wing angle of attack for stall. The closer the lift vector is to vertical (wings level), the more effective the applied g is in recovering the airplane.

A smooth application of up to full lateral control should provide enough roll control power to establish a very positive recovery roll rate. If full roll control application is not satisfactory, it may even be necessary to apply some rudder in the direction of the desired roll.

Only a small amount of rudder is needed. Too much rudder applied too quickly or held too long may result in loss of lateral and directional control or structural failure.

Nose High, High Bank Angles

A nose high, high angle of bank upset requires deliberate flight control inputs. A large bank angle is helpful in reducing excessively high pitch attitudes. The pilot must apply nose-down elevator and adjust the bank angle to achieve the desired rate of pitch reduction while considering energy management. Once the pitch attitude has been reduced to the desired level, it is necessary only to reduce the bank angle, ensure that sufficient airspeed has been achieved, and return the airplane to level flight.

Nose Low, High Bank Angles

The nose low, high angle of bank upset requires prompt action by the pilot as altitude is rapidly being exchanged for airspeed. Even if the airplane is at a high enough altitude that ground impact is not an immediate concern, airspeed can rapidly increase beyond airplane design limits. Simultaneous application of roll and adjustment of thrust may be necessary. It may be necessary to apply nose-down elevator to limit the amount of lift, which will be acting toward the ground if the bank angle exceeds 90 degrees. This also reduces wing angle of attack to improve roll capability. Full aileron and spoiler input should be used if necessary to smoothly establish a recovery roll rate toward the nearest horizon. It is important to not increase g force or use nose-up elevator or stabilizer until approaching wings level. The pilot should also extend the speedbrakes as needed.

Upset Recovery Techniques

It is possible to consolidate and incorporate recovery techniques into two basic scenarios, nose high and nose low, and to acknowledge the potential for high bank angles in each scenario described above. Other crew actions such as recognizing the upset, reducing automation, and completing the recovery are included in these techniques. The recommended techniques provide a logical progression for recovering an airplane.

If an upset situation is recognized, immediately accomplish the Upset Recovery maneuver found in the non-normal maneuvers section in the QRH.

Windshear

General

Improper or ineffective vertical flight path control has been one of the primary factors in many cases of flight into terrain. Low altitude windshear encounters are especially significant because windshear can place the crew in a situation which requires the maximum performance capability of the airplane. Windshear encounters near the ground are the most threatening because there is very little time or altitude to respond to and recover from an encounter.

Airplane Performance in Windshear

Knowledge of how windshear affects airplane performance can be essential to the successful application of the proper vertical flight path control techniques during a windshear encounter.

The wind component is mostly horizontal at altitudes below 500 feet. Horizontal windshear may improve or degrade vertical flight path performance. Windshear that improves performance is first indicated in the flight deck by an increasing airspeed. This type of windshear may be a precursor of a shear that decreases airspeed and degrades vertical flight path performance.

Airspeed decreases if the tailwind increases, or headwind decreases, faster than the airplane is accelerating. As the airspeed decreases, the airplane normally tends to pitch down to maintain or regain the in-trim speed. The magnitude of pitch change is a function of the encountered airspeed change. If the pilot attempts to regain lost airspeed by lowering the nose, the combination of decreasing airspeed and decreasing pitch attitude produces a high rate of descent. Unless this is countered by the pilot, a critical flight path control situation may develop very rapidly. As little as 5 seconds may be available to recognize and react to a degrading vertical flight path.

737 NG Flight Crew Training Manual

In critical low altitude situations, trade airspeed for altitude, if possible. An increase in pitch attitude, even though the airspeed may be decreasing, increases the lifting force and improves the flight path angle. Proper pitch control, combined with maximum available thrust, utilizes the total airplane performance capability.

The crew must be aware of the normal values of airspeed, altitude, rate of climb, pitch attitude and control column forces. Unusual control column force may be required to maintain or increase pitch attitude when airspeed is below the in-trim speed. If significant changes in airspeed occur and unusual control forces are required, the crew should be alerted to a possible windshear encounter and be prepared to take action.

Avoidance, Precautions and Recovery

Crew actions are divided into three areas: Avoidance, Precautions and Recovery. For more information on avoidance and precautions, see the Windshear supplementary procedure in Volume 1 of the FCOM. For specific crew actions for recovery, see the Non-Normal Maneuvers section in the QRH.



Intentionally
Blank



Non-Normal Operations

Chapter 8

Table of Contents

Section TOC

Preface 8.1

Non-Normal Situation Guidelines 8.1

 Troubleshooting 8.2

 Approach and Landing 8.3

 Landing at the Nearest Suitable Airport 8.3

Air Systems 8.4

 Cabin Altitude Warning 8.4

Ditching 8.5

 Send Distress Signals 8.5

 Advise Crew and Passengers 8.5

 Fuel Burn-Off 8.5

 Passenger Cabin Preparation 8.5

 Ditching Final 8.5

 Initiate Evacuation 8.6

Electrical 8.6

 Approach and Landing on Standby Power 8.6

Engines, APU 8.6

 Engine Failure vs Engine Fire After Takeoff 8.6

 Engine Tailpipe Fire 8.7

 Loss of Engine Thrust Control 8.7

 Loss of Thrust on Both Engines 8.8

 Engine Severe Damage Accompanied by High Vibration 8.8

 Recommended Technique for an In-Flight Engine Shutdown 8.9

Evacuation	8.9
Method of Evacuation	8.10
Discharging Fire Bottles during an Evacuation	8.10
Flight Controls	8.11
Leading Edge or Trailing Edge Device Malfunctions	8.11
Flap Extension using the Alternate System	8.13
Jammed or Restricted Flight Controls	8.13
Stabilizer Trim Inoperative	8.15
Runaway Stabilizer	8.16
Manual Stabilizer Trim	8.16
Standby Rudder On (As Installed)	8.17
Flight Instruments, Displays	8.17
Airspeed Unreliable	8.17
Fuel	8.18
Fuel Balance	8.18
Fuel Leak	8.19
Low Fuel	8.20
Hydraulics	8.20
Hydraulic System(s) Inoperative - Landing	8.20
Landing Gear	8.22
Tire Failure during or after Takeoff	8.22
Landing on a Flat Tire	8.22
Partial or Gear Up Landing	8.23
Overspeed	8.25
Tail Strike	8.26
Takeoff Risk Factors	8.26



737 NG Flight Crew Training Manual

Landing Risk Factors	8.27
Wheel Well Fire	8.29
Windows	8.30
Window Damage	8.30
Flight with the Side Window(s) Open	8.30
Situations Beyond the Scope of Non-Normal Checklists	8.30
Basic Aerodynamics and Systems Knowledge	8.31
Flight Path Control	8.32
Recall Checklists	8.32
Communications	8.33
Damage Assessment and Airplane Handling Evaluation	8.33
Landing Airport	8.34



Intentionally
Blank



Preface

This chapter describes pilot techniques associated with accomplishing selected Non-Normal Checklists (NNCs) and provides guidance for situations beyond the scope of NNCs. Aircrews are expected to accomplish NNCs listed in the QRH. These checklists ensure maximum safety until appropriate actions are completed and a safe landing is accomplished. Techniques discussed in this chapter minimize workload, improve crew coordination, enhance safety, and provide a basis for standardization. A thorough review of the QRH section CI.2, (Checklist Introduction, Non-Normal Checklists), is an important prerequisite to understanding this chapter.

Non-Normal Situation Guidelines

When a non-normal situation occurs, the following guidelines apply:

- **NON-NORMAL RECOGNITION:** The crewmember recognizing the malfunction calls it out clearly and precisely
- **MAINTAIN AIRPLANE CONTROL:** It is mandatory that the Pilot Flying (PF) fly the airplane while the Pilot Monitoring (PM) accomplishes the NNC. Maximum use of the autoflight system is recommended to reduce crew workload
- **ANALYZE THE SITUATION:** NNCs should be accomplished only after the malfunctioning system has been positively identified

Note: Pilots should don oxygen masks and establish communications anytime oxygen deprivation or air contamination is suspected, even though an associated warning has not occurred.

- **TAKE THE PROPER ACTION:** Although many in-flight non-normal situations require immediate corrective action, difficulties can be compounded by the rate the PF issues commands and the speed of execution by the PM. Commands must be clear and concise, allowing time for acknowledgment of each command prior to issuing further commands. The PF must exercise positive control by allowing time for acknowledgment and execution. The other crewmembers must be certain their reports to the PF are clear and concise, neither exaggerating nor understating the nature of the non-normal situation. This eliminates confusion and ensures efficient, effective, and expeditious handling of the non-normal situation
- **EVALUATE THE NEED TO LAND:** If the NNC directs the crew to land at the nearest suitable airport, or if the situation is so identified in the QRH section CI.2, (Checklist Introduction, Non-Normal Checklists), diversion to the nearest airport where a safe landing can be accomplished is required. If the NNC or the Checklist Introduction do not direct landing at the nearest suitable airport, the pilot must determine if continued flight to destination may compromise safety.

Troubleshooting

Troubleshooting can be defined as taking steps beyond the published checklist in an effort to improve or correct a non-normal condition. Examples of this are:

- attempting to reset a system, or cycling a circuit breaker when not prescribed by the NNC
- using maintenance-level information to dictate crew actions
- use of switches and controls intended only for maintenance.

Troubleshooting is rarely helpful and has caused further loss of system function or failure, and in some cases, accidents and incidents. The crew should consider additional actions beyond the checklist only when completion of the published checklist steps clearly result in an unacceptable situation. In the case of airplane controllability problems when a safe landing is considered unlikely, airplane handling evaluations with gear, flaps or speedbrakes extended may be appropriate. Also, attempting to free jammed flight controls should only be attempted if the airplane cannot be safely landed with the existing condition and then, according to the NNC to the extent possible.

Crew distraction, caused by preoccupation with troubleshooting, has been a key factor in fuel starvation and CFIT accidents. Boeing recommends completion of the NNC as published whenever possible, in particular for flight control malfunctions that are addressed by a NNC. Guidance for situations beyond the scope of the non-normal checklist is provided later in this chapter.

Approach and Landing

When a non-normal situation occurs, a rushed approach can often complicate the situation. Unless circumstances require an immediate landing, complete all corrective actions before beginning the final approach.

For some non-normal conditions, the possibility of higher airspeed on approach, longer landing distance, a different flare picture or a different landing technique should be considered.

Plan an extended straight-in approach with time allocated for the completion of any lengthy NNC steps such as the use of alternate flap or landing gear extension systems. Arm autobrakes and speedbrakes unless precluded by the NNC.

Note: The use of autobrakes is recommended because maximum autobraking may be more effective than maximum manual braking due to timely application upon touchdown and symmetrical braking. However, the Advisory Information in the PI chapter of the QRH provides Non-normal Configuration Landing Distance data based upon the use of maximum manual braking. When used properly, maximum manual braking provides the shortest stopping distance.

Fly a normal glide path and attempt to land in the normal touchdown zone. After landing, use available deceleration measures to bring the airplane to a complete stop on the runway. The captain must determine if an immediate passenger evacuation should be accomplished or if the airplane can be safely taxied off the runway.

Landing at the Nearest Suitable Airport

“Plan to land at the nearest suitable airport” is a phrase used in the QRH. This section explains the basis for that statement and how it is applied.

In a non-normal situation, the pilot-in-command, having the authority and responsibility for operation and safety of the flight, must make the decision to continue the flight as planned or divert. In an emergency situation, this authority may include necessary deviations from any regulation to meet the emergency. In all cases, the pilot-in-command is expected to take a safe course of action.

The QRH assists flight crews in the decision making process by indicating those situations where “landing at the nearest suitable airport” is required. These situations are described in the Checklist Introduction or the individual NNC.

The regulations regarding an engine failure are specific. Most regulatory agencies specify that the pilot-in-command of a twin engine airplane that has an engine failure or engine shutdown shall land at the nearest suitable airport at which a safe landing can be made.

A suitable airport is defined by the operating authority for the operator based on guidance material, but in general must have adequate facilities and meet certain minimum weather and field conditions. If required to divert to the nearest suitable airport (twin engine airplanes with an engine failure), the guidance material also typically specifies that the pilot should select the nearest suitable airport “in point of time” or “in terms of time.” In selecting the nearest suitable airport, the pilot-in-command should consider the suitability of nearby airports in terms of facilities and weather and their proximity to the airplane position. The pilot-in-command may determine, based on the nature of the situation and an examination of the relevant factors, that the safest course of action is to divert to a more distant airport than the nearest airport. For example, there is not necessarily a requirement to spiral down to the airport nearest the airplane's present position if, in the judgment of the pilot-in-command, it would require equal or less time to continue to another nearby airport.

For persistent smoke or a fire which cannot positively be confirmed to be completely extinguished, the safest course of action typically requires the earliest possible descent, landing and passenger evacuation. This may dictate landing at the nearest airport appropriate for the airplane type, rather than at the nearest suitable airport normally used for the route segment where the incident occurs.

Air Systems

Cabin Altitude Warning

There have been several reports of cabin altitude warning alerts caused by improperly configured engine bleed air and air conditioning pack switches. This condition is often the result of crews failing to reconfigure switches following a no engine bleed takeoff. Additionally, there have been reports of crews delaying their response to the cabin altitude warning alert because it was confused with the takeoff configuration warning horn.

In order to address the problem of incorrectly positioning switches that affect pressurization, the normal takeoff procedure has been modified to direct the crew to set or verify the correct position of the engine bleed air and air conditioning pack switches after flap retraction is complete. Engine bleeds and air conditioning packs have also been included as specific items in the After Takeoff normal checklist. Additionally, when doing a no engine bleed takeoff, reference to the No Engine Bleed Takeoff supplementary procedure, in conjunction with good crew coordination, reduces the possibility of crew errors.

737 NG Flight Crew Training Manual

Confusion between the cabin altitude warning horn and the takeoff configuration warning horn can be resolved if the crew remembers that the takeoff configuration warning horn is only armed when the airplane is on the ground. If this horn is activated in flight, it indicates that the cabin altitude has reached 10,000 feet. In this case, the crew should immediately initiate the Cabin Altitude Warning or Rapid Depressurization NNC.

Ditching

Send Distress Signals

Transmit Mayday, current position, course, speed, altitude, situation, intention, time and position of intended touchdown, and type of airplane using existing air-to-ground frequency. Set transponder code 7700 and, if practical, determine the course to the nearest ship or landfall.

Advise Crew and Passengers

Alert the crew and the passengers to prepare for ditching. Assign life raft positions (as installed) and order all loose equipment in the airplane secured. Put on life vests, shoulder harnesses, and seat belts. Do not inflate life vests until after exiting the airplane.

Fuel Burn-Off

Consider burning off fuel prior to ditching, if the situation permits. This provides greater buoyancy and a lower approach speed. However, do not reduce fuel to a critical amount, as ditching with engine power available improves ability to properly control touchdown.

Passenger Cabin Preparation

Confer with cabin personnel either by interphone or by having them report to the flight deck in person to ensure passenger cabin preparations for ditching are complete.

Ditching Final

Transmit final position. Select flaps 40 or landing flaps appropriate for the existing conditions.

Advise the cabin crew of imminent touchdown. On final approach announce ditching is imminent and advise crew and passengers to brace for impact. Maintain airspeed at VREF. Maintain 200 to 300 fpm rate of descent. Plan to touchdown on the windward side and parallel to the waves or swells, if possible. To accomplish the flare and touchdown, rotate smoothly to touchdown attitude of 10° to 12°. Maintain airspeed and rate of descent with thrust.

Initiate Evacuation

After the airplane has come to rest, proceed to assigned ditching stations and evacuate as soon as possible, ensuring all passengers are out of the airplane.

Deploy slides/rafts. Be careful not to rip or puncture the slides/rafts. Avoid drifting into or under parts of the airplane. Remain clear of fuel-saturated water.

Electrical

Approach and Landing on Standby Power

The probability of a total and unrecoverable AC power failure is remote. Because of system design, a NNC for accomplishing an approach and landing on standby power is not required. However, some regulatory agencies require pilots to train for this condition. During training, or in the unlikely event that a landing must be made on standby power, the following guidelines should be considered.

Complete all applicable NNCs and approach preparations. Manual pressurization control and manual stabilizer trim are required. The left navigation radios and communication radio are operable on standby power. Use right ignition. On some airplanes, the captain's electronic flight instruments and left FMC are available.

Note: Refer to Volume 2, Chapter 6 of the FCOM for a list of significant equipment powered by standby power.

Fly the approach on speed. Only partial anti-skid is available so excess approach airspeed is undesirable. Brake with caution. The flap position indicator is inoperative. Auto brakes and auto speedbrakes are not available. Reverse thrust is available.

Engines, APU

Engine Failure vs Engine Fire After Takeoff

The NNC for an engine failure is normally accomplished after the flaps have been retracted and conditions permit.

In case of an engine fire, when the airplane is under control, the gear has been retracted, and a safe altitude has been attained (minimum 400 feet AGL) accomplish the NNC recall items. Due to asymmetric thrust considerations, Boeing recommends that the PF retard the affected thrust lever after the PM confirms that the PF has identified the correct engine. Reference items should be accomplished on a non-interfering basis with other normal duties after the flaps have been retracted and conditions permit.

Engine Tailpipe Fire

Engine tailpipe fires are typically caused by engine control malfunctions that result in the ignition of pooled fuel. These fires can be damaging to the engine and have caused unplanned passenger evacuations.

If a tailpipe fire is reported, the crew should accomplish the NNC without delay. Flight crews should consider the following when dealing with this situation:

- motoring the engine is the primary means of extinguishing the fire
- to prevent an inappropriate evacuation, flight attendants should be notified without significant delay
- communications with ramp personnel and the tower are important to determine the status of the tailpipe fire and to request fire extinguishing assistance
- the engine fire checklist is inappropriate because the engine fire extinguishing agent is not effective against a fire inside the tailpipe.

Loss of Engine Thrust Control

All turbo fan engines are susceptible to this malfunction whether engine control is hydro-mechanical, hydro-mechanical with supervisory electronics (e.g. PMC) or Full Authority Digital Engine Control (FADEC). Engine response to a loss of control varies from engine to engine. Malfunctions have occurred in-flight and on the ground. The major challenge the flight crew faces when responding to this malfunction is recognizing the condition and determining which engine has malfunctioned. This condition can occur during any phase of flight.

Failure of engine or fuel control system components, or loss of thrust lever position feedback has caused loss of engine thrust control. Control loss may not be immediately evident since many engines fail to some fixed RPM or thrust lever condition. This fixed RPM or thrust lever condition may be very near the commanded thrust level and therefore difficult to recognize until the flight crew attempts to change thrust with the thrust lever. Other engine responses include: shutdown, operation at low RPM, or thrust at the last valid thrust lever setting (in the case of a thrust lever feedback fault) depending on altitude or air/ground logic. In all cases, the affected engine does not respond to thrust lever movement.

The Engine Limit/Surge/Stall NNC is written to include this malfunction. Since recognition may be difficult, if a loss of engine control is suspected, the flight crew should continue the takeoff or remain airborne until the Engine Limit/Surge/Stall NNC can be accomplished. This helps with directional control and may preclude an inadvertent shutdown of the wrong engine. In some conditions, such as during low speed ground operations, immediate engine shutdown may be necessary to maintain directional control.

Loss of Thrust on Both Engines

Dual engine failure is a situation that demands prompt action regardless of altitude or airspeed. Accomplish recall items and establish the appropriate airspeed to immediately attempt a windmill restart. There is a higher probability that a windmill start will succeed if the restart attempt is made as soon as possible (or immediately after recognizing an engine failure) to take advantage of high engine RPM. Use of higher airspeeds and altitudes below 30,000 feet improves the probability of a restart. Loss of thrust at higher altitudes may require descent to a lower altitude to improve windmill starting capability.

The inflight start envelope defines the region where windmill starts were demonstrated during certification. It should be noted that this envelope does not define the only areas where a windmill start may be successful. The dual engine failure NNC is written to ensure flight crews take advantage of the high RPM at engine failure regardless of altitude or airspeed. A subsequent APU start may be initiated as soon as practical to provide electrical power and starter assist during a subsequent engine start attempt if the rapid restart is not successful. Initiate the rapid restart recall procedure before attempting an APU start for the reasons identified above.

During a rapid restart, EGT may exceed the displayed limit for one-engine starts. During restart attempts with both engines failed, use the takeoff EGT limit. A hung or stalled in-flight start is normally indicated by stagnant RPM and increasing EGT. During start, engines may accelerate to idle slowly but action should not be taken if RPM is increasing and EGT is not near or rapidly approaching the limit.

Note: When electrical power is restored, do not confuse the establishment of APU generator power with the establishment of engine generator power at idle RPM and advance the thrust lever prematurely.

Engine Severe Damage Accompanied by High Vibration

Certain engine failures, such as fan blade separation can cause high levels of airframe vibration. Although the airframe vibration may seem severe to the flight crew, it is extremely unlikely that the vibration will damage the airplane structure or critical systems. However, the vibration should be reduced as soon as possible by reducing airspeed and descending. As altitude and airspeed change, the airplane may transition through various levels of vibration. In general, vibration levels decrease as airspeed decreases, however, at a given altitude vibration may temporarily increase or decrease as airspeed changes.

If vibration remains unacceptable, descending to a lower altitude (terrain permitting) allows a lower airspeed and normally lower vibration levels. Vibration will likely become imperceptible as airspeed is further reduced during approach.

737 NG Flight Crew Training Manual

The impact of a vibrating environment on human performance is dependent on a number of factors, including the orientation of the vibration relative to the body. People working in a vibrating environment may find relief by leaning forward or backward, standing, or otherwise changing their body position.

Once airframe vibration has been reduced to acceptable levels, the crew must evaluate the situation and determine a new course of action based on weather, fuel remaining, and available airports.

Recommended Technique for an In-Flight Engine Shutdown

Any time an engine shutdown is required in flight, good crew coordination is essential. Airplane incidents have turned into airplane accidents as a result of the flight crew shutting down the incorrect engine.

When the flight path is under complete control, the crew should proceed with a deliberate, systematic process that identifies the correct engine and ensures that the incorrect engine is not shut down. Do not rush through the shutdown procedure, even for a fire indication. Operators may develop their own crew coordination techniques that meet these objectives. The following technique is an example that could be used:

When an engine shutdown is required, the PF verbally confirms the correct engine with the PM, then disconnects the A/T and slowly retards the thrust lever of the engine that will be shutdown.

Coordinate activation of the start lever as follows:

- PM places a hand on and verbally identifies the start lever for the engine that will be shutdown
- PF verbally confirms that the PM has identified the correct engine
- PF directs the PM to move the start lever to cutoff.

If the NNC requires activation of the engine fire switch, coordinate as follows:

- PM places a hand on and verbally identifies the engine fire switch for the engine that will be shutdown
- PF verbally confirms that the PM has identified the correct engine
- PF directs the PM to pull engine fire switch.

Evacuation

If an evacuation is planned and time permits, a thorough briefing and preparation of the crew and passengers will increase the chances of a successful evacuation. Flight deck preparations should include a review of pertinent checklists and any other actions to be accomplished. Appropriate use of autobrakes should be discussed. If evacuating due to fire in windy conditions, consider positioning the airplane so the fire is on the downwind side.

Notify cabin crew of possible adverse conditions at the affected exits. The availability of various exits may differ for each situation. Crewmembers must make the decision as to which exits are usable for the circumstances.

For unplanned evacuations, the captain needs to analyze the situation carefully before initiating an evacuation order. Quick actions in a calm and methodical manner will improve the chances for a successful passenger evacuation.

Method of Evacuation

When there is a need to evacuate passengers and crew, the captain has to choose between commanding an emergency evacuation using the emergency escape slides or less urgent means such as deplaning using stairs, jetways, or other means. All available sources of information should be used to determine the safest course of action including reports from the cabin crew, other aircraft, and air traffic control. The captain must then determine the best means of passenger evacuation by carefully considering all factors. These include, but are not limited to:

- the urgency of the situation, including the possibility of significant injury or loss of life if a significant delay occurs
- the type of threat to the airplane, including structural damage, fire, reported bomb on board, etc.
- the possibility of fire spreading rapidly from spilled fuel or other flammable materials
- the extent of damage to the airplane
- the possibility of passenger injury during an emergency evacuation using the escape slides.

If in doubt, the crew should consider an emergency evacuation using the escape slides.

Discharging Fire Bottles during an Evacuation

The evacuation NNC specifies discharge of the engine or APU fire bottles if an engine or APU fire warning light is illuminated. However, evacuation situations can present possibilities regarding the potential for fire that are beyond the scope of the NNC and may not activate an engine or APU fire warning. The crew should consider the following when deciding whether to discharge one or more fire bottles into the engines and/or APU:

- if an engine fire warning light is not illuminated, but a fire indication exists or a fire is reported in or near an engine, discharge both available fire bottles into the affected engine
- if the APU fire warning light is not illuminated, but a fire indication exists or a fire is reported in or near the APU, discharge the APU bottle

737 NG Flight Crew Training Manual

- the discharged halon agent is designed to extinguish a fire and has very little or no fire prevention capability in the engine nacelles. Halon dissipates quickly into the atmosphere
 - there is no reason to discharge the engine or APU fire bottles for evacuations not involving fire indications existing or reported in or near an engine or APU, e.g., cargo fire, security or bomb threat, etc.
-

Flight Controls

Leading Edge or Trailing Edge Device Malfunctions

Leading edge or trailing edge device malfunctions can occur during extension or retraction. This section discusses all flaps up and partial or asymmetrical leading/trailing edge device malfunctions for landings.

All Flaps Up Landing

The probability of both leading and trailing edge devices failing to extend is remote. If a flaps up landing situation were to be encountered in service, the pilot should consider the following techniques. Training to this condition should be limited to the flight simulator.

After selecting a suitable landing airfield and prior to beginning the approach, consider reduction of airplane gross weight (burn off fuel) to reduce touchdown speed.

Fly a wide pattern to allow for the increased turning radius required for the higher maneuvering speed. Establish final approximately 10 miles from the runway. This allows time to extend the gear and decelerate to the target speed while in level flight and complete all required checklists. Maintain no slower than flaps up maneuvering speed until established on final. Maneuver with normal bank angles until on final.

Final Approach

Use an ILS glide slope if available. Do not reduce the airspeed to the final approach speed until aligned with the final approach. Before intercepting the descent profile, decrease airspeed to command speed and maintain this speed until the landing is assured.

The normal rate of descent on final is approximately 900 fpm due to the higher ground speed. Final approach body attitude is approximately 1° - 2° higher than a flaps 30 approach. Do not make a flat approach (shallow glide path angle) or aim for the threshold of the runway. Plan touchdown at the 1,000 foot point.

Use manual control of thrust levers. Due to automatic speed protection, autothrottle use may result in higher than desired speed on final. Engines will be at low idle speed due to no flap extension. When engines are near idle RPM, time required for engines to accelerate is longer than normal.

Note: Use of the autopilot during approach phase is acceptable. Do not autoland.

Speedbrakes are not recommended for airspeed reduction below 800 feet. If landing is anticipated beyond the normal touch down zone, go around.

Landing

Fly the airplane onto the runway at the recommended touchdown point. Flare only enough to achieve an acceptable reduction in the rate of descent. Do not allow the airplane to float. Floating just above the runway surface to deplete additional speed wastes available runway and increases the possibility of a tail strike. Do not risk touchdown beyond the normal touchdown zone in an effort to achieve a smooth landing.

Slight forward pressure on the control column may be required to achieve touchdown at the desired point and to lower the nosewheel to the runway. After lowering the nosewheel to the runway, hold forward control column pressure and expeditiously accomplish the landing roll procedure. Full reverse thrust is required for a longer period of time.

Use of autobrakes is recommended. Autobrake setting should be consistent with runway length. Use manual braking if deceleration is not suitable for the desired stopping distance.

Immediate initiation of reverse thrust at main gear touchdown (reverse thrust is more effective at high speeds) and full reverse thrust allows the autobrake system to reduce brake pressure to the minimum level. Less than maximum reverse thrust increases brake energy requirements and may result in excessive brake temperatures.

Leading Edge Flaps Transit - Landing

If an asymmetrical or skewed leading edge device condition occurs, the adjusted VREF provides 15° bank angle maneuvering capability and allows for 15° overshoot protection in all cases.

Do not hold the airplane off during landing flare. Floating just above the runway surface to deplete the additional threshold speed wastes available runway and increases the possibility of a tail strike.

Note: If the gear is retracted during a go-around and flap position is greater than 25, a landing gear configuration warning occurs.

737 NG Flight Crew Training Manual

Trailing Edge Flap Asymmetry - Landing

If a trailing edge flap up asymmetry occurs, full maneuvering capability exists even if the asymmetry occurred at flaps just out of the full up position. Burn off fuel to reduce landing weight and lower approach speed.

Fly accurate airspeeds in the landing pattern. At lesser flap settings, excess airspeed is difficult to dissipate, especially when descending on final approach. Pitch attitude and rate of descent on final is higher than for a normal landing. During flare, airspeed does not bleed off as rapidly as normal.

Fly the airplane onto the runway at the recommended touchdown point. Flare only enough to achieve an acceptable reduction in the rate of descent. Do not allow the airplane to float. Floating just above the runway surface to deplete additional speed wastes available runway and increases the possibility of a tail strike. Do not risk touchdown beyond the normal touchdown zone in an effort to achieve a smooth landing.

Note: If the gear is retracted during a go-around and flap position is greater than 25, a landing gear configuration warning occurs.

Flap Extension using the Alternate System

When extending the flaps using the alternate system, the recommended method for setting command speed differs from the method used during normal flap extension. Since the flaps extend more slowly when using the alternate system, it is recommended that the crew delay setting the new command speed until the flaps reach the selected position. This method may prevent the crew from inadvertently getting into a low airspeed condition if attention to airspeed is diverted while accomplishing other duties.

Jammed or Restricted Flight Controls

Although rare, jamming of the flight control system has occurred on commercial airplanes. A jammed flight control can result from ice accumulation due to water leaks onto cables or components, dirt accumulation, component failure such as cable break or worn parts, improper lubrication, or foreign objects.

A flight control jam may be difficult to recognize, especially in a properly trimmed airplane. A jam in the pitch axis may be more difficult to recognize than a jam in other axes. In the case of the elevator, the jammed control can be masked by trim. Some indications of a jam are:

- unexplained autopilot disconnect
- autopilot that cannot be engaged
- undershoot or overshoot of an altitude during autopilot level-off
- higher than normal control forces required during speed or configuration changes

If any jammed flight control condition exists, both pilots should apply force to try to either clear the jam or activate the override feature. There should be no concern about damaging the flight control mechanism by applying too much force to either clear a jammed flight control or activate an override feature. Maximum force may result in some flight control surface movement with a jammed flight control. If the jam clears, both pilot's flight controls are available.

Note: If a control is jammed due to ice accumulation, the jam may clear when moving to a warmer temperature.

Some flight controls are linked together through override features. If the jam does not clear, activation of an override feature allows a flight control surface to be moved independent of the jammed control. Applying force to the non-jammed flight control activates the override feature. When enough force is applied, the jammed control is overridden allowing the non-jammed control to operate. To identify the non-jammed flight control, apply force to each flight control individually. The flight control that results in the greatest airplane control is the non-jammed control.

Note: The pilot of the non-jammed control should be the pilot flying for the remainder of the flight.

The non-jammed control requires a normal force, plus an additional override force to move the flight control surface. For example, if a force of 10 lbs (4 kg) is normally required to move the surface, and 50 lbs (23 kg) of force is required to activate the override, a total force of 60 lbs (27 kg) is required to move the control surface while in override. Response is slower than normal with a jammed flight control; however, sufficient response is available for airplane control and landing.

For those controls without override features, limited flight control surface deflection occurs when considerable force is applied to the flight control. This response is due to cable stretch and structural bending. This response may be sufficient for airplane control and landing.

Note: There is an override feature that allows control of the ailerons or spoilers. There is also an override feature that allows control of the elevator in the event of a control column jam.

Trim Inputs

If a jammed flight control condition exists, use manual inputs from other control surfaces to counter pressures and maintain a neutral flight control condition. The following table provides trim inputs that may be used to counter jammed flight control conditions.

737 NG Flight Crew Training Manual

Jammed Control Surface	Manual Trim Inputs
Elevator	Stabilizer
Aileron	Rudder*
Rudder	Aileron*
*Asymmetric engine thrust may aid roll and directional control.	

Approach and Landing

Attempt to select a runway with minimum crosswind. Complete approach preparations early. Recheck flight control surface operation prior to landing to determine if the malfunction still exists. Do not make abrupt thrust, speedbrake, or configuration changes. Make small bank angle changes. On final approach, do not reduce thrust to idle until after touchdown. Asymmetrical braking and asymmetrical thrust reverser deployment may aid directional control on the runway.

Note: In the event of an elevator jam, control forces will be significantly greater than normal and control response will be slower than normal to flare the airplane.

Go Around Procedure

If the elevator is known or suspected to be jammed, a go-around should be avoided if at all possible. To execute a go-around with a jammed elevator, smoothly advance throttles while maintaining pitch control with stabilizer and any available elevator. If a go-around is required, the go-around procedure is handled in the same manner as a normal go-around.

Stabilizer Trim Inoperative

The stabilizer trim may become inoperative for number of reasons. The most common reason is a failed stabilizer motor. This failure mode causes a loss of electric trim through both the autopilot and control wheel switches, but manual trim is still available using the trim wheels. This failure mode is addressed using the STABILIZER TRIM INOPERATIVE NNC.

Other, less common failure modes that are also addressed using the STABILIZER TRIM INOPERATIVE NNC include:

- a lodged or stuck stabilizer motor. This failure mode causes a loss of electric trim through both the autopilot and control wheel switches, but manual trim is still available using the trim wheels by overriding autopilot and main electric trim brake systems. The effort required to manually rotate the trim wheels in this condition is higher than normal
- a lodged or stuck stabilizer actuator. This failure mode causes a loss of electric trim through both the autopilot and control wheel switches and a loss of manual trim. The result is a stabilizer that cannot be trimmed. Flight tests have demonstrated the airplane can be flown and landed safely with stabilizer trim inoperative
 - a lodged or stuck stabilizer actuator can be the result of ice on the jackscrew. If the crew suspects that the failure could be due to ice accumulation, descend to a warmer temperature and try again.

Runaway Stabilizer

Hold the control column firmly to maintain the desired pitch attitude. If uncommanded trim motion continues, the stabilizer trim commands are interrupted when the control column is displaced in the opposite direction.

Manual Stabilizer Trim

If manual stabilizer trim is necessary, ensure both stabilizer trim cutout switches are in CUTOUT prior to extending the manual trim wheel handles.

Excessive airloads on the stabilizer may require effort by both pilots to correct the mis-trim. In extreme cases it may be necessary to aerodynamically relieve the airloads to allow manual trimming. Accelerate or decelerate towards the in-trim speed while attempting to trim manually.

Anticipate the trim changes required for the approach. Configure the airplane early in the approach. When reaching the landing configuration, maintain as constant a trim setting as possible. If a go-around is required, anticipate the trim changes as airspeed increases.

Standby Rudder On (As Installed)

The STANDBY RUDDER ON light illuminates any time the standby rudder PCU is operating. If this light illuminates independent of crew action or a hydraulic system malfunction, either of two conditions may have occurred. The most probable cause is a force fight monitor malfunction inadvertently activating the standby pump and powering the standby PCU. In this case, three PCU control valves power the rudder and full rudder inputs should be avoided to prevent applying excessive loads on the rudder. The NNC is written for this condition. The second cause may be because of a pressure difference between the two main PCU control valves indicating a jammed condition. This condition does not require a NNC because satisfactory rudder operation is available using the standby rudder PCU.

Flight Instruments, Displays

Airspeed Unreliable

Unreliable airspeed indications can result from blocking or freezing of the pitot/static system or a severely damaged or missing radome. When the ram air inlet to the pitot head is blocked, pressure in the probe is released through the drain holes and the airspeed slowly drops to zero. If the ram air inlet and the probe drain holes are both blocked, pressure trapped within the system reacts unpredictably. The pressure may increase through expansion, decrease through contraction, or remain constant. In all cases, the airspeed indications would be abnormal. This could mean increasing indicated airspeed in climb, decreasing indicated airspeed in descent, or unpredictable indicated airspeed in cruise.

If the flight crew is aware of the problem, flight without the benefit of valid airspeed information can be safely conducted and should present little difficulty. Early recognition of erroneous airspeed indications require familiarity with the interrelationship of attitude, thrust setting, and airspeed. A delay in recognition could result in loss of airplane control.

The flight crew should be familiar with the approximate pitch attitude for each flight maneuver. For example, climb performance is based on maintaining a particular airspeed or Mach number. This results in a specific body attitude that varies little with gross weight and altitude. Any significant change from the body attitude required to maintain a desired airspeed should alert the flight crew to a potential problem.

When the abnormal airspeed is recognized, immediately return the airplane to the target attitude and thrust setting for the flight regime. If continued flight without valid airspeed indications is necessary, consult the Flight With Unreliable Airspeed/Turbulent Air Penetration table in the Performance Inflight section of the QRH for the correct attitude, thrust settings, and V/S for actual airplane gross weight and altitude.

Ground speed information is available from the FMC and on the instrument displays. These indications can be used as a cross check. Many air traffic control radars can also measure ground speed.

For airplanes equipped with an Angle of Attack (AOA) indicator, maintain the analog needle at approximately the three o'clock position. This approximates a safe maneuvering speed or approach speed for the existing airplane configuration.

Descent

Idle thrust descents to 10,000 feet can be made by flying body attitude and checking rate of descent in the QRH tables. At 2,000 feet above the selected level off altitude, reduce rate of descent to 1,000 FPM. On reaching the selected altitude, establish attitude and thrust for the airplane configuration. If possible, allow the airplane to stabilize before changing configuration and altitude.

Approach

If available, accomplish an ILS approach. Establish landing configuration early on final approach. At glide slope intercept or beginning of descent, set thrust and attitude per the QRH tables and control the rate of descent with thrust.

Landing

Control the final approach so as to touch down approximately 1,000 feet to 1,500 feet beyond the threshold. Fly the airplane on to the runway, do not hold it off or let it “float” to touchdown.

Use autobraking if available. If manual braking is used, maintain adequate brake pedal pressure until a safe stop is assured. Immediately after touchdown, expeditiously accomplish the landing roll procedure.

Fuel

Fuel Balance

The primary purpose of fuel balance limitations on Boeing airplanes is for the structural life of the airframe and landing gear and not for controllability. A reduction in structural life of the airframe or landing gear can be caused by frequently operating with out-of-limit fuel balance conditions. Lateral control is not significantly affected when operating with fuel beyond normal balance limits.

737 NG Flight Crew Training Manual

The primary purpose for fuel balance alerts are to inform the crew that imbalances beyond the current state may result in increased trim drag and higher fuel consumption. The IMBAL NNC should be accomplished when the fuel balance alert is received.

There is a common misconception among flight crews that the fuel crossfeed valve should be opened immediately after an in-flight engine shutdown to prevent fuel imbalance. This practice is contrary to Boeing recommended procedures and could aggravate a fuel imbalance. This practice is especially significant if an engine failure occurs and a fuel leak is present. Arbitrarily opening the crossfeed valve and starting fuel balancing procedures, without following the checklist, can result in pumping usable fuel overboard.

The misconception may be further reinforced during simulator training. The fuel pumps in simulators are modeled with equal output pressure on all pumps so opening the crossfeed valve appears to maintain a fuel balance. However, the fuel pumps in the airplane have allowable variations in output pressure. If there is a sufficient difference in pump output pressures and the crossfeed valve is opened, fuel feeds to the operating engine from the fuel tank with the highest pump output pressure. This may result in fuel unexpectedly coming from the tank with the lowest quantity.

Fuel Balancing Considerations

The crew should consider the following when performing fuel balancing procedures:

- use of the Fuel Balancing Supplementary Procedure in conjunction with good crew coordination reduces the possibility of crew errors
- routine fuel balancing when not near the imbalance limit increases the possibility of crew errors and does not significantly improve fuel consumption
- during critical phases of flight, fuel balancing should be delayed until workload permits. This reduces the possibility crew errors and allows crew attention to be focused on flight path control
- fuel imbalances that occur during approach need not be addressed if the reason for the imbalance is obvious (e.g. engine failure or thrust asymmetry, etc.).

Fuel Leak

Any time an unexpected fuel quantity indication, FMC fuel message, or imbalance condition is experienced, a fuel leak should be considered as a possible cause. Maintaining a fuel log and comparing actual fuel burn to the flight plan fuel burn can help the pilot recognize a fuel leak.

Significant fuel leaks, although fairly rare, are difficult to detect. The NNC assumes the leak is between the strut and the engine. There is no specific fuel leak annunciation on the flight deck. A leak must be detected by discrepancies in the fuel log, by visual confirmation, or by some annunciation that occurs because of a leak. Any unexpected change in fuel quantity or fuel balance should alert the crew to the possibility of a leak. If a leak is suspected, it is imperative to follow the NNC.

Low Fuel

A low fuel condition exists when the fuel LOW indication is displayed.

Approach and Landing

In a low fuel condition, the clean configuration should be maintained as long as possible during the descent and approach to conserve fuel. However, initiate configuration changes early enough to provide a smooth, slow deceleration to final approach speed to prevent fuel from running forward in the tanks.

A normal landing configuration and airspeed appropriate for the wind conditions are recommended.

Runway conditions permitting, heavy braking and high levels of reverse thrust should be avoided to prevent uncovering all fuel pumps and possible engine flameout during landing roll.

Go-Around

If a go-around is necessary, apply thrust slowly and smoothly and maintain the minimum nose-up body attitude required for a safe climb gradient. Avoid rapid acceleration of the airplane. If any wing tank fuel pump low pressure light illuminates, do not turn the fuel pump switches off.

Hydraulics

Proper planning of the approach is important. Consideration should be given to the effect the inoperative system(s) has on crosswind capabilities, autoflight, stabilizer trim, control response, control feel, reverse thrust, stopping distance, go-around configuration and performance required to reach an alternate airfield.

Hydraulic System(s) Inoperative - Landing

If the landing gear is extended using manual gear extension, the gear cannot be raised. Trailing edge flaps can be extended or retracted using the alternate (electric) system. However, the rate of flap travel is significantly reduced. Leading edge devices can also be extended using the alternate system, but they cannot be retracted.

737 NG Flight Crew Training Manual

Flaps 15 is used to improve go-around capabilities. The airplane may tend to float during the flare. Do not allow the airplane to float. Fly the airplane onto the runway at the recommended point.

If nose wheel steering is inoperative and any crosswind exists, consideration should be given to landing on a runway where braking action is reported as good or better. Braking action becomes the primary means of directional control below approximately 60 knots where the rudder becomes less effective. If controllability is satisfactory, taxi clear of the runway using differential thrust and brakes. Continued taxi with nose wheel steering inoperative is not recommended due to airplane control difficulties and heat buildup in the brakes.

Manual Reversion

With both hydraulic systems A and B inoperative, the ailerons and elevator are controlled manually. A noticeable dead band will be observed in both of these controls. High control forces are required for turns and the control wheel must be forcibly returned to the aileron neutral position.

Both electric and manual trim are still functional. Do not overtrim. The airplane should be trimmed slightly nose up and a light forward pressure held on the control column to minimize the effects of the elevator dead band.

The rudder is powered by the standby hydraulic system. Caution must be exercised to not overcontrol the rudder.

Note: The standby rudder includes a yaw damper which aids roll control handling qualities in the aileron dead band area during manual reversion.

Fly a long straight-in approach. Keep thrust changes small and slow to allow for pitch trim changes. Landing configuration and approach airspeed should be established on the runway centerline so that only a slight reduction in thrust is required to achieve the landing profile. Do not make a flat approach. Anticipate the airplane will tend to pitch down as thrust is reduced for touchdown. This pitch down tendency is reduced if the airplane is trimmed slightly nose up to minimize the effects of the elevator dead band.

After touchdown, thrust reverser operation is slow. Apply steady brake pressure since only accumulator pressure is available. Do not apply excessive forward pressure to the control column. Excessive forward pressure without the speedbrakes deployed can result in less weight on the main gear and reduced braking capability.

Do not attempt to taxi the airplane after stopping because the accumulator pressure may be depleted or close to being depleted.

If a go-around is required, apply thrust smoothly and in coordination with stabilizer trim. Rapid thrust application results in nose-up pitch forces.

Landing Gear

Tire Failure during or after Takeoff

If the crew suspects a tire failure during takeoff, the ATS facility serving the departing airport should be advised of the potential for tire pieces remaining on the runway. The crew should consider continuing to the destination unless there is an indication that other damage has occurred (non-normal engine indications, engine vibrations, hydraulic system failures or leaks, etc.).

Continuing to the destination will allow the airplane weight to be reduced normally, and provide the crew an opportunity to plan and coordinate their arrival and landing when the workload is low.

Considerations in selecting a landing airport include, but are not limited to:

- sufficient runway length and acceptable surface conditions to account for the possible loss of braking effectiveness
- sufficient runway width to account for possible directional control difficulties
- altitude and temperature conditions that could result in high ground speeds on touchdown and adverse taxi conditions
- runway selection options regarding "taxi-in" distance after landing
- availability of operator maintenance personnel to meet the airplane after landing to inspect the wheels, tires, and brakes before continued taxi
- availability of support facilities should the airplane need repair.

Landing on a Flat Tire

Boeing airplanes are designed so that the landing gear and remaining tire(s) have adequate strength to accommodate a flat nose gear tire or main gear tire. When the pilot is aware of a flat tire prior to landing, use normal approach and flare techniques, avoid landing overweight and use the center of the runway. Use differential braking as required for directional control. With a single tire failure, towing is not necessary unless unusual vibration is noticed or other failures have occurred.

In the case of a flat nose wheel tire, slowly and gently lower the nose wheel to the runway while braking lightly. Runway length permitting, use idle reverse thrust. Autobrakes may be used at the lower settings. Once the nose gear is down, vibration levels may be affected by increasing or decreasing control column back pressure. Maintain nose gear contact with the runway.

Flat main gear tire(s) cause a general loss of braking effectiveness and a yawing moment toward the flat tire with light or no braking and a yawing moment away from the flat tire if the brakes are applied harder. Maximum use of reverse thrust is recommended. Do not use autobrakes.

737 NG Flight Crew Training Manual

If uncertain whether a nose tire or a main tire has failed, slowly and gently lower the nose wheel to the runway and do not use autobrakes. Differential braking may be required to steer the airplane. Use idle or higher reverse thrust as required to stop the airplane.

Note: Extended taxi distances or fast taxi speeds can cause significant increases in temperatures on the remaining tires.

Partial or Gear Up Landing

Land on all available gear. The landing gear absorbs the initial shock and delays touchdown of airplane body parts. Recycling the landing gear in an attempt to extend the remaining gear is not recommended. A gear up or partial gear landing is preferable to running out of fuel while attempting to solve a gear problem.

Landing Runway

Consideration should be given to landing at the most suitable airport with adequate runway and fire fighting capability. Foaming the runway is not necessary. Tests have shown that foaming provides minimal benefit and it takes approximately 30 minutes to replenish the fire truck's foam supply.

Prior to Approach

If time and conditions permit, reduce weight as much as possible by burning off fuel to attain the slowest possible touchdown speed.

At the captain's command, advise the crew and the passengers of the situation, as needed. Coordinate with all ground emergency facilities. For example, fire trucks normally operate on a common VHF frequency with the airplane and can advise the crew of the airplane condition during the landing. Advise the cabin crew to perform emergency landing procedures and to brief passengers on evacuation procedures.

The NNC instructs the crew to inhibit the ground proximity system as needed to prevent nuisance warnings when close to the ground with the gear retracted.

For landing in any gear configuration, establish approach speed early and maintain a normal rate of descent.

Landing Techniques

Attempt to keep the airplane on the runway to minimize airplane damage and aid in passenger evacuation. After touchdown lower the nose gently before losing elevator effectiveness. Use all aerodynamic capability to maintain directional control on the runway. At touchdown speed the rudder has sufficient authority to provide directional control in most configurations. At speeds below 60 knots, use nose wheel/rudder pedal steering, if available, and differential braking as needed.

Use of Speedbrakes

During a partial gear or gear up landing, speedbrakes should be extended only when stopping distance is critical. Extending the speedbrakes before all gear, or the nose or the engine nacelle in the case of a gear that does not extend, have contacted the runway may compromise controllability of the aircraft. Extending the speedbrakes after a complete touchdown also creates a risk of not being able to stow the speedbrakes after the aircraft has come to a rest. If this is the case, there would be an increase in the probability of injuring passengers if the over wing exits are used for evacuation.

When landing with any gear that indicates up or partially extended, attempt to fly the area with the unsafe indication smoothly to the runway at the lowest speed possible, but before losing flight control effectiveness. A smooth touchdown at a low speed helps to reduce airplane damage and offers a better chance of keeping the airplane on the runway. Since the airplane is easier to control before body parts make ground contact, delay extending the speedbrakes until after the nose and both sides of the airplane have completed touchdown. If the speedbrakes are deployed before all areas have made contact with the runway, the airplane will complete touchdown sooner and at a higher speed.

Use of Reverse Thrust

During a partial gear or gear up landing, an engine making ground contact could suffer sufficient damage such that the thrust reverser mechanism may not operate. Selecting reverse thrust with any gear not extended may produce an additional asymmetric condition that makes directional control more difficult. Reverse thrust should be used only when stopping distance is critical.

If reverse thrust is needed, keep in mind that the airplane is easier to control before body parts make ground contact. If the thrust reversers are deployed before all gear, or the nose or the engine nacelle in the case of a gear that does not extend, have made contact with the runway, the airplane will complete touchdown sooner and at a higher speed.

After Stop

Accomplish a passenger evacuation, if required.

Partial or Gear Up Combinations

Both Main Gear Extended with Nose Gear Up

Land in the center of the runway. After touchdown lower the nose gently before losing elevator effectiveness.

737 NG Flight Crew Training Manual

Nose Gear Only Extended

Land in the center of the runway. Use normal approach and flare attitudes maintaining back pressure on the control column until ground contact. The engines contact the ground prior to the nose gear.

One Main Gear Extended and Nose Gear Extended

Land the airplane on the side of the runway that corresponds to the extended main gear down. At touchdown, maintain wings level as long as possible. Use rudder and nose wheel steering for directional control. After all gear, or the engine nacelle where the gear is not extended, have made contact with the runway, braking on the side opposite the unsupported wing should be used as required to keep the airplane rolling straight.

One Main Gear Only Extended

Land the airplane on the side of the runway that corresponds to the extended main gear down. At touchdown, maintain wings level as long as possible. Use rudder for directional control. After all gear, or the nose or the engine nacelle in the case of gear that do not extend, have made contact with the runway, braking on the side opposite the unsupported wing should be used as required to keep the airplane rolling straight.

All Gear Up or Partially Extended

Land in the center of the runway. The engines contact the ground first. There is adequate rudder available to maintain directional control during the initial portion of the ground slide. Attempt to maintain the centerline while rudder control is available.

Overspeed

VMO/MMO is the airplane maximum certified operating speed and should not be intentionally exceeded. However, crews occasionally can experience inadvertent overspeeds. Airplanes have been flight tested beyond VMO/MMO to ensure smooth pilot inputs will return the airplane safely to the normal flight envelope.

During cruise, the typical causes of overspeed events are windshear encounters or high altitude wave activity. Although autothrottle logic provides for more aggressive control of speed as the airplane approaches VMO or MMO, there are some windshears and wave activity speed changes that are beyond the capability of the autothrottle system to prevent short term overspeeds.

When correcting an overspeed during cruise at high altitude, avoid reducing thrust to idle which results in slow engine acceleration back to cruise thrust and may result in overcontrolling the airspeed or a loss of altitude. If autothrottle corrections are not satisfactory, temporarily deploying partial speedbrakes can assist in reducing speed and avoiding the need for idle thrust.

During descents at or near VMO/MMO, most overspeeds are encountered after the autopilot initiates capture of the VNAV path from above or during a level-off when the speedbrakes were required to maintain the path. In these cases, if the speedbrakes are retracted during the level-off, the airplane can momentarily overspeed. During descents using speedbrakes near VMO/MMO, delay retraction of the speedbrakes until after VNAV path or altitude capture is complete. Crews routinely climbing or descending in windshear conditions may wish to consider a 5 to 10 knot reduction in climb or descent speeds to reduce overspeed occurrences. This will have a minimal effect on fuel consumption and total trip time.

When encountering an inadvertent overspeed condition, crews should leave the autopilot engaged unless it is apparent that the autopilot is not correcting the overspeed. However, if manual inputs are required, disconnect the autopilot. Be aware that disconnecting the autopilot to avoid or reduce the severity of an inadvertent overspeed may result in an abrupt pitch change.

During climb or descent, if VNAV or LVL CHG pitch control is not correcting the overspeed satisfactorily, switching to the V/S mode temporarily may be helpful in controlling speed. In the V/S mode, the selected vertical speed can be adjusted slightly to increase the pitch attitude to help correct the overspeed. As soon as the speed is below VMO/MMO, VNAV or LVL CHG may be re-selected.

Note: Anytime VMO/MMO is exceeded, the maximum airspeed should be noted in the flight log.

Tail Strike

Tail strike occurs when the lower aft fuselage or tail skid (as installed) contacts the runway during takeoff or landing. A significant factor that appears to be common is the lack of flight crew experience in the model being flown. Understanding the factors that contribute to a tail strike can reduce the possibility of a tail strike occurrence.

Note: Anytime fuselage contact is suspected or known to have occurred, accomplish the appropriate NNC.

Takeoff Risk Factors

Any one of the following takeoff risk factors may precede a tail strike:

737 NG Flight Crew Training Manual

Mistrimmed Stabilizer

This usually results from using erroneous takeoff data, e.g., the wrong weights, or an incorrect center of gravity (CG). In addition, sometimes accurate information is entered incorrectly either in the flight management system (FMS) or set incorrectly on the stabilizer. The flight crew can prevent this type of error and correct the condition by challenging the reasonableness of the load sheet numbers. Comparing the load sheet numbers against past experience in the airplane can assist in approximating numbers that are reasonable.

Rotation at Improper Speed

This situation can result in a tail strike and is usually caused by early rotation due to some unusual situation, or rotation at too low an airspeed for the weight and/or flap setting.

Trimming during Rotation

Trimming the stabilizer during rotation may contribute to a tail strike. The pilot flying may easily lose the feel of the elevator while the trim is running which may result in an excessive rotation rate.

Excessive Rotation Rate

Flight crews operating an airplane model new to them, especially when transitioning from an airplane with unpowered flight controls to one with hydraulic assistance, are most vulnerable to using excessive rotation rate. The amount of control input required to achieve the proper rotation rate varies from one model to another. When transitioning to a new model, flight crews may not realize that it does not respond to pitch input in exactly the same way as their previous model.

Improper Use of the Flight Director

The flight director provides accurate pitch guidance only after the airplane is airborne. With the proper rotation rate, the airplane reaches 35 feet with the desired pitch attitude of about 15 degrees. However, an aggressive rotation into the pitch bar at takeoff is not appropriate and can cause a tail strike.

Landing Risk Factors

A tail strike on landing tends to cause more serious damage than the same event during takeoff and is usually more expensive and time consuming to repair. In the worst case, the tail can strike the runway before the landing gear, thus absorbing large amounts of energy for which it is not designed. The aft pressure bulkhead is often damaged as a result.

Any one of the following landing risk factors may precede a tail strike:

Unstabilized Approach

An unstabilized approach is the biggest single cause of tail strike. Flight crews should stabilize all approach variables - on centerline, on approach path, on speed, and in the final landing configuration - by the time the airplane descends through 1,000 feet above ground level (AGL). This is not always possible. Under normal conditions, if the airplane descends through 1,000 feet AGL (IMC), or 500 feet AGL (VMC), with these approach variables not stabilized, a go-around should be considered.

Flight recorder data show that flight crews who continue with an unstabilized condition below 500 feet seldom stabilize the approach. When the airplane arrives in the flare, it often has either excessive or insufficient airspeed. The result is a tendency toward large power and pitch corrections in the flare, often culminating in a vigorous pitch change at touchdown resulting in tail strike shortly thereafter. If the pitch is increased rapidly when touchdown occurs as ground spoilers deploy, the spoilers add additional nose up pitch force, reducing pitch authority, which increases the possibility of tail strike. Conversely, if the airplane is slow, increasing the pitch attitude in the flare does not effectively reduce the sink rate; and in some cases, may increase it.

A firm touchdown on the main gear is often preferable to a soft touchdown with the nose rising rapidly. In this case, the momentary addition of power may aid in preventing the tail strike. In addition, unstabilized approaches can result in landing long or a runway over run.

Holding Off in the Flare

The second most common cause of a landing tail strike is an extended flare, with a loss in airspeed that results in a rapid loss of altitude, (a dropped-in touchdown). This condition is often precipitated by a desire to achieve an extremely smooth/soft landing. A very smooth/soft touchdown is not essential, nor even desired, particularly if the runway is wet.

Trimming in the Flare

Trimming the stabilizer in the flare may contribute to a tail strike. The pilot flying may easily lose the feel of the elevator while the trim is running. Too much trim can raise the nose, even when this reaction is not desired. The pitch up can cause a balloon, followed either by dropping in or pitching over and landing in a three-point attitude. Flight crews should trim the airplane during the approach, but not in the flare.

Mishandling of Crosswinds

When the airplane is placed in a forward slip attitude to compensate for the wind effects, this cross-control maneuver reduces lift, increases drag, and may increase the rate of descent. If the airplane then descends into a turbulent surface layer, particularly if the wind is shifting toward the tail, the stage is set for tail strike.

The combined effects of high closure rate, shifting winds with the potential for a quartering tail wind, can result in a sudden drop in wind velocity commonly found below 100 feet. Combining this with turbulence can make the timing of the flare very difficult. The pilot flying can best handle the situation by using additional thrust, if required, and by using an appropriate pitch change to keep the descent rate stable until initiation of the flare. Flight crews should clearly understand the criteria for initiating a go-around and plan to use this time-honored avoidance maneuver when needed.

Over-Rotation during Go-Around

Go-arounds initiated very late in the approach, such as during the landing flare or after touching down, are a common cause of tail strikes. When the go-around mode is initiated, the flight director immediately commands a go-around pitch attitude. If the pilot flying abruptly rotates up to the pitch command bar, a tail strike can occur before the airplane responds and begins climbing. During a go-around, an increase in thrust as well as a positive pitch attitude is needed. If the thrust increase is not adequate for the increased pitch attitude, the resulting speed decay will likely result in a tail strike. Another contributing factor in tail strikes may be a strong desire by the flight crew to avoid landing gear contact after initiating a late go-around when the airplane is still over the runway. In general, this concern is not warranted because a brief landing gear touchdown during a late go-around is acceptable. This had been demonstrated during autoland and go-around certification programs.

Wheel Well Fire

Prompt execution of the Wheel Well Fire NNC following a wheel well fire warning is important for timely gear extension. Landing gear speed limitations should be observed during this procedure.

If airspeed is above 270 knots/.82 Mach, the airspeed must be reduced before extending the landing gear. A rapid way to reduce airspeed during climb or descent is to select LVL CHG to open the MCP command speed window and then set approximately 250 knots. An alternate way to reduce airspeed during a climb or descent is to select altitude hold and select a lower speed. With the autothrottle in a speed mode, thrust levers may be reduced to idle and/or speedbrakes may be used to expedite deceleration.

Note: To avoid unintended deceleration below the new target airspeed, the autothrottle should remain engaged.

Windows

Window Damage

If both forward windows delaminate or forward vision is unsatisfactory, accomplish an autoland, if the ILS facility is satisfactory.

Flight with the Side Window(s) Open

The inadvertent opening of an unlatched flight deck window by air loads during the takeoff roll is not considered an event that warrants a high speed RTO. Although the resulting noise levels may interfere with crew communications, the crew should consider continuing the takeoff and close the window after becoming airborne and the flight path is under control.

If required, the windows may be opened in-flight, at or below holding speeds, after depressurizing the airplane. It is recommended that the airplane be slowed since the noise levels increase at higher airspeed. Intentions should be briefed and ATC notified prior to opening the window as the noise level is high, even at slow speeds. Because of airplane design, there is an area of relatively calm air over the open window. Forward visibility can be maintained by looking out of the open window using care to stay clear of the airstream.

Situations Beyond the Scope of Non-Normal Checklists

It is rare to encounter in-flight events which are beyond the scope of the Boeing recommended NNCs. These events can arise as a result of unusual occurrences such as a midair collision, bomb explosion or other major malfunction. In these situations the flight crew may be required to accomplish multiple NNCs, selected elements of several different NNCs applied as necessary to fit the situation, or be faced with little or no specific guidance except their own judgement and experience. Because of the highly infrequent nature of these occurrences, it is not practical or possible to create definitive flight crew NNCs to cover all events.

737 NG Flight Crew Training Manual

The following guidelines may aid the flight crew in determining the proper course of action should an in-flight event of this type be encountered. Although these guidelines represent what might be called “conventional wisdom”, circumstances determine the course of action which the crew perceives will conclude the flight in the safest manner.

Basic Aerodynamics and Systems Knowledge

Knowledge of basic aerodynamic principles and airplane handling characteristics and a comprehensive understanding of airplane systems can be key factors in situations of this type.

Basic aerodynamic principles are known and understood by all pilots. Although not a complete and comprehensive list, following are a brief review of some basic aerodynamic principles and airplane systems information relevant to such situations:

- if aileron control is affected, rudder inputs can assist in countering unwanted roll tendencies. The reverse is also true if rudder control is affected
- if both aileron and rudder control are affected, the use of asymmetrical engine thrust may aid roll and directional control
- if elevator control is affected, stabilizer trim, bank angle and thrust can be used to control pitch attitude. To do this effectively, engine thrust and airspeed must be coordinated with stabilizer trim inputs. The airplane continues to pitch up if thrust is increased and positive corrective action is not taken by re-trimming the stabilizer. Flight crews should be aware of the airplane’s natural tendency to oscillate in the pitch axis if the stable pitch attitude is upset. These oscillations are normally self damping in Boeing airplanes, but to ensure proper control, it may be desirable to use thrust and/or stabilizer trim to hasten damping and return to a stable condition. The airplane exhibits a pitch up when thrust is increased and a pitch down when thrust is decreased. Use caution when attempting to dampen pitch oscillations by use of engine thrust so that applications of thrust are timed correctly, and diverging pitch oscillations do not develop
- a flight control break-out feature is designed into all Boeing airplanes. If a jammed flight control exists, both pilots can apply force to either clear the jam or activate the break-out feature. There should be no concern about damaging the mechanism by applying too much force. In certain cases, clearing the jam may permit one of the control columns to operate the flight controls with portions of a control axis jammed. It may be necessary to apply break-out forces for the remainder of the flight on the affected control axis

- stall margin decreases with angle of bank and increasing load factors. Therefore, it is prudent to limit bank angle to 15 degrees in the event maneuvering capability is in question. Increasing the normal flap/speed maneuvering schedule while staying within flap placard limits provides extra stall margin where greater bank angles are necessary
- all Boeing airplanes have the capability to land using any flap position, including flaps up. Use proper maneuvering and final approach speeds and ensure adequate runway is available to stop the airplane after landing.

Flight Path Control

When encountering an event of the type described above, the flight crew's first consideration should be to maintain or regain full control of the airplane and establish an acceptable flight path. This may require use of unusual techniques such as the application of full aileron or rudder or in an asymmetrical thrust situation, reduction of power on the operating engine(s) to regain lateral control. This may also require trading altitude for airspeed or vice versa. The objective is to take whatever action is necessary to control the airplane and maintain a safe flight path. Even in a worst case condition where it is not possible to keep the airplane flying and ground contact is imminent, a "controlled crash" is a far better alternative than uncontrolled flight into terrain.

If the operation of flaps is in doubt, leading and trailing edge flap position should not be changed unless it appears that airplane performance immediately requires such action. Consideration should be given to the possible effects of an asymmetrical flap condition on airplane control, if flap position is changed. If no flap damage exists, wing flaps should be operated as directed in the associated NNC. Anytime an increasing rolling moment is experienced during flap transition, (indicating a failure to automatically shutdown an asymmetric flap situation) return the flap handle to the previous position.

Unusual events adversely affecting airplane handling characteristics while airborne may continue to adversely affect airplane handling characteristics during landing ground roll. Aggressive differential braking and/or use of asymmetrical reverse thrust, in addition to other control inputs, may be required to maintain directional control.

Recall Checklists

After flight path control has been established, accomplish the recall steps of appropriate NNCs. The emphasis at this point should be on containment of the problem. Execution of NNC actions commences when the airplane flight path and configuration are properly established.

737 NG Flight Crew Training Manual

Accomplish all applicable NNCs prior to commencing final approach. Exercise common sense and caution when accomplishing multiple NNCs with differing direction. The intended course of action should be consistent with the damage assessment and handling evaluation.

Communications

Establish flight deck communications as soon as possible. This may require use of the flight deck interphone system or, in extreme cases of high noise levels, hand signals and gestures in order to communicate effectively.

Declare an emergency with Air Traffic Control (ATC) to assure priority handling and emergency services upon landing. Formulate an initial plan of action and inform ATC. If possible, request a discrete radio frequency to minimize distractions and frequency changes. If unable to establish radio communication with ATC, squawk 7700 and proceed as circumstances dictate.

Communications with the cabin crew and with company ground stations are important, but should be accomplished as time permits. If an immediate landing is required, inform the cabin crew as soon as possible.

Damage Assessment and Airplane Handling Evaluation

Unless circumstances such as imminent airplane breakup or loss of control dictate otherwise, the crew should take time to assess the effects of the damage and/or conditions before attempting to land. Use caution when reducing airspeed to lower flaps. Make configuration and airspeed changes slowly until a damage and controllability assessment has been accomplished and it is certain that lower airspeeds can be safely used. In addition, limit bank angle to 15 degrees and avoid large or rapid changes in engine thrust and/or airspeed. If possible, conduct this assessment and handling evaluation at an altitude that provides a safe margin for recovery should flight path control be inadvertently compromised. It is necessary for the flight crew to use good judgement in consideration of the existing conditions and circumstances to determine an appropriate altitude for this evaluation.

The assessment should start with an examination of flight deck indications to assess damage. Consideration should be given to the potential cumulative effect of the damage. A thorough understanding of airplane systems operation can greatly facilitate this task.

If structural damage is suspected, attempt to assess the magnitude of the damage by direct visual observation from the flight deck and/or passenger cabin. While only a small portion of the airplane is visible to the flight crew from the flight deck, any visual observation data could be used to gain maximum knowledge of airplane configuration and status and could be valuable in determining subsequent actions.

The flight crew should consider contacting the company to both inform them of the situation and as a potential source of useful information. In addition to current and forecast weather, and airfield conditions, it may be possible to obtain technical information and recommendations from expert sources. These expert sources are available from within the company as well as from Boeing.

If controllability is in question, consider performing a check of the airplane handling characteristics. The purpose of this check is to determine minimum safe speeds and appropriate configuration for landing. Limit bank to 15 degrees and avoid rapid thrust and airspeed changes which might adversely affect controllability. If flap damage has occurred, prior to accomplishing this check, consider the possible effects on airplane control should an asymmetrical condition occur if flap position is changed. Accomplish this check by slowly and methodically reducing speed and lowering the flaps; lower the gear only if available thrust permits.

As a starting point, use the flap/speed schedule as directed in the appropriate NNC. If stick shaker or initial stall buffet are encountered at or before reaching the associated flap speed, or if a rapid increase in wheel deflection and full rudder deflection are necessary to maintain wings level, increase speed to a safe level and consider this speed to be the minimum approach speed for the established configuration.

If airplane performance is a concern, use of the alternate flap or gear extension systems may dictate that the configuration portion of this check be accomplished in conjunction with the actual approach. Configuration changes made by the alternate systems may not be reversible. The crew must exercise extreme caution on final approach with special emphasis on minimum safe speeds and proper airplane configuration. If asymmetrical thrust is being used for roll control or pitch authority is limited, plan to leave thrust on until touchdown.

After the damage assessment and handling characteristics are evaluated, the crew should formulate a sequential plan for the completion of the flight.

Landing Airport

The following items should be considered when selecting an airport for landing:

- weather conditions (VMC preferred)
- enroute time
- length of runway available (longest possible runway preferred, wind permitting)
- emergency services available
- flight crew familiarity
- other factors dictated by the specific situation.



A

Acceleration Height - All Engines 1.14

Acceleration Height - Engine Out 1.14

Acceleration to and Deceleration from VMO 7.1

Adverse Runway Conditions - Takeoff 3.16

AFDS Autoland Capabilities 5.16

AFDS Faults 5.21

AFDS Guidelines 1.35

Airspeed Unreliable 8.17

Alert Height - AH 5.11

Antiskid Inoperative - Taxi 2.5

Approach Briefing 5.2

Approach Category 5.2

Approach Clearance 5.3

Approach to Stall Recovery 7.8

Assumed Temperature Method - Takeoff 3.14

Autopilot Engagement - After Takeoff 3.25

Autothrottle Use 1.35

B

Body Clearance at Touchdown 6.16

Bounced Landing Recovery 6.10

Bug Setting with FMC Inoperative 1.18

C

Cabin Altitude Warning 8.4

Callouts 1.19

CAT II Operations 5.19

CAT III Operations 5.20

Category II Approach Autopilot 5.19

Category II Approach Flight Director 5.20

Category II Operations 5.19

Category III Operations 5.20

Category IIIa 5.20



Center-Of-Gravity (C.G.) on Takeoff	3.11
Circling Approach	5.55
Circling Approach - One Engine Inoperative	5.57
Climb Constraints	4.1
Climb Performance Takeoff (Improved)	3.15
Cold Temperature Altitude Corrections	1.26
Command Speed	1.15
Command Speed - Non-Normal Conditions	1.16
Crew Resource Management (CRM)	1.2
Crosswind Landings	6.34
Crosswind Takeoff	3.12
Cruise Performance Economy	4.9

D

Decision Altitude/Height - DA(H)	5.11,15
Deicing/Anti-Icing Fluids - Effect on Takeoff	3.17
Delayed Flap Approach - ILS	5.15
Derate (Fixed) - Takeoff	3.15
Descent Constraints	4.16
Descent Path	4.16
Descent Planning	4.17
Descent Rates	4.17
Descent Speed Determination	4.16
Ditching	8.5
Dual Channel Approach and Go-Around Warnings - Fail Operational	5.24
Dual Channel Approach and Go-Around Warnings - Fail Passive	5.22

E

Economy Climb	4.3
Economy Climb Schedule - FMC Data Unavailable	4.4
Electrical System Malfunctions	8.6
Electronic Flight Bag (EFB)	1.24
Engine Failure Recognition - Takeoff	3.27
Engine Failure vs Engine Fire After Takeoff	8.6

737 NG Flight Crew Training Manual

Engine Icing during Climb	4.3
Engine Icing during Descent	4.19
Engine Inoperative Climb	4.4
Engine Inoperative Cruise/Driftdown	4.11
Engine Inoperative, Rudder Trim - All Instrument Approaches	5.27
Engine Out Familiarization	7.2
Engine Severe Damage Accompanied by High Vibration	8.8
ETOPS	4.12

F

Fixed Derate - Takeoff	3.33
Flap - Speed Schedule/Maneuvering Speeds	1.3
Flap Extension using the Alternate System	8.13
Flap Operation	1.14
Flap Retraction - One Engine Inoperative	3.32
Flap Retraction Schedule	3.25
Flap Usage	1.3
Flaps and Landing Gear	4.19
Flaps Up Landing	8.11
Flare and Touchdown	6.9
Flight Management Computer(s)/CDUs	1.30
Flight Path Vector (FPV)	1.25
FMC Route Verification Techniques	1.30
Fuel Balance	8.18
Fuel for Enroute Climb	4.8
Fuel Temperature	4.8

G

Go-Around after Touchdown	5.67
Go-Around and Missed Approach - All Engines Operating	5.66
Go-Around and Missed Approach - All Instrument Approaches	5.65
Go-Around and Missed Approach - Engine Failure During	5.68
Go-Around and Missed Approach - One Engine Inoperative	5.68
Go/Stop Decision near V1	3.20
GPS use in Non-WGS-84 Reference Datum Airspace	1.34

H	
Headphone and Flight Deck Speaker Use	1.3
High Altitude High Speed Flight	4.12
High Altitude Maneuvering, "G" Buffet	7.4
Holding	4.20
Holding Airspeeds (FAA)	4.21
Holding Airspeeds (ICAO)	4.21
HUDS - Cruise	4.8
HUDS - Descent Preparation	4.17
HUDS - Initiating Takeoff Roll	3.6
Hydraulic System Malfunctions	8.20

I	
Icing - Operation in Icing Conditions	1.27
Icing - Training Flights in Icing Conditions	1.27
ILS - One Engine Inoperative	5.26
ILS Approach	5.9
ILS Performance	5.17
Immediate Turn after Takeoff - All Engines	3.24
Immediate Turn after Takeoff - One Engine Inoperative	3.31
Initial Climb - All Engines	3.24
Initial Climb - One Engine Inoperative	3.31
Instrument Approach Using V/S	5.50
Instrument Approach Using VNAV	5.40
Instrument Approaches	5.1
Integrated Approach Navigation (IAN)	5.45

J	
Jammed or Restricted Flight Controls	8.13

L	
Landing at the Nearest Suitable Airport	8.3
Landing Configurations and Speeds	6.1
Landing Configurations and Speeds (Non-Normal)	6.1
Landing Distance (Factors Affecting)	6.23
Landing Distance (Non-Normal)	6.2
Landing Flare Profile	6.9

737 NG Flight Crew Training Manual

Landing Minima	5.6
Landing on a Flat Tire	8.22
Landing Roll	6.22
Leading Edge Flaps Transit - Landing	8.12
Liftoff - Effect of Rotation Speed and Pitch Rate	3.10
LNAV - Non-ILS Approaches	5.33
Loss of Engine Thrust Control	8.7
Loss of Thrust on Both Engines	8.8
Low Altitude Level Off - During Climb	4.2
Low Fuel Operations In-flight	8.20
Low Visibility Approaches	5.18
Low Visibility Takeoff	3.16

M

Maintenance Inspection (Events Requiring)	1.1
Maneuver Margin - Landing and Go-Around	6.1
Maneuver Margins to Stick Shaker	1.5
Manual Stabilizer Trim	8.16,17
Maximum Altitude - Cruise	4.5
Maximum Angle Climb	4.4
Maximum Rate Climb	4.4
Minimum Fuel Operation - Takeoff	3.24
Missed Approach (Mandatory Conditions)	5.5
Missed Approach - Non-ILS	5.54
Missed Approach Points (MAP)	5.6

N

Noise Abatement - One Engine Inoperative	3.32
Noise Abatement Takeoff	3.26
Non - ILS Instrument Approach - Vertical Path Construction	5.37
Non - ILS Instrument Approaches	5.29
Non-Normal Operations	5.25
Non-Normal Situation Guidelines	8.1
Nose Wheel/Rudder Pedal Steering	2.5

O

Operational Philosophy	1.1
------------------------	-----



737 NG Flight Crew Training Manual

Optimum Altitude - Cruise	4.6
Overspeed	8.25
Overweight Landing	6.36
P	
Partial or Gear Up Landing	8.23
Passenger Evacuation	8.9
Pilot Incapacitation	1.37
Pitch and Roll Limit Conditions	6.20
Polar Operations	4.14
Precision Approach Path Indicator (PAPI)	6.7
Procedure Holding	4.20
Procedure Turn	5.4
Procedure Turn and Initial Approach - ILS	5.12
Procedure Turn and Initial Approach - Non-ILS Approaches	5.37
Push Back	2.2
Q	
Qualification Requirements (Checkride)	1.2
R	
Radio Altimeter (RA)	5.6
Rapid Descent	7.5
Raw Data - (No Flight Director) - ILS	5.15
Raw Data Monitoring Requirements - Non-ILS Approaches	5.31,32
Recovery from a Fully Developed Stall	7.20
Reduced Thrust - One Engine Inoperative	3.32
Reduced Thrust Climb	4.1
Reduced Thrust Takeoff	3.14
Reference Bugs	1.17
Rejected Landing	6.11
Rejected Takeoff Decision	3.19
Rejected Takeoff Maneuver	3.20
Resolution Advisory (RA)	7.23
Reverse Thrust (Ground Operations)	2.2
Reverse Thrust Operation (Landing Roll)	6.30
RNP and RNAV Operations	1.31

737 NG Flight Crew Training Manual

Roll Modes - Takeoff	3.25
Rotation and Liftoff - All Engines	3.7
Rotation and Liftoff - One Engine Inoperative	3.27
RTO Execution Operational Margins	3.21
Runaway Stabilizer	8.16
Runway Markings (Typical)	6.8

S

Situations Beyond the Scope of Non-Normal Checklists	8.30
Speed Intervention	4.16
Speed Restrictions	4.19
Speedbrakes	4.18
Stabilized Approach Recommendations	5.4
Stabilizer Trim Inoperative	8.15
Stall Recovery	7.8
Steep Turns	7.21
Stick Shaker and Stall Speeds	7.11
Stop and Go Landings	5.63

T

Tail Strike	8.26
Takeoff	3.2
Takeoff - Engine Failure	3.27
Takeoff - Tail Clearance	3.8,29
Takeoff Briefing	2.1
Takeoff Crosswind Guidelines	3.12
Takeoff Field Length (FAR)	3.17
Takeoff Profile	3.2
Taxi	2.2
Taxi - Adverse Weather	2.11
Taxi - Minimum Radius Turns	2.7
Taxi - One Engine	2.13
Taxi Speed and Braking	2.4
Terrain Avoidance	7.22
Threshold Height	6.9
Thrust Management - Takeoff	3.3



Thrust Use - Taxi	2.4
Touch and Go Landings	5.62
Touchdown Body Attitudes	6.11
Traffic Advisory (TA)	7.23
Traffic Alert and Collision Avoidance System (TCAS)	7.22
Trailing Edge Flap Asymmetry - Landing	8.13
Training Objectives	1.2
Transition to Climb	4.2
Trim Technique - Rudder	1.28
Troubleshooting	8.2
Turbulent Air Penetration	1.38
U	
Upset Recovery	7.24
V	
Visual Aim Point	6.7
Visual Approach Slope Indicator (VASI/T-VASI)	6.3
Visual Descent Point	5.53
Visual Traffic Pattern	5.59
VNAV - Non-ILS Approaches	5.34
W	
Weather Radar and Terrain Display Policy	1.35
Wheel Well Fire	8.29
Window Damage	8.30
Window(s) Open	8.30
Windshear	7.28