

FINAL REPORT

**ACCIDENT
INVOLVING ATR 72 AIRCRAFT
REGISTRATION MARKS TS-LBB
ditching off the coast of Capo Gallo (Palermo - Sicily)
August 6th, 2005**

AGENZIA NAZIONALE
PER LA SICUREZZA DEL VOLO

www.ansv.it

e-mail: safety.info@ansv.it

LIST OF CONTENTS

LIST OF CONTENTS	I
GLOSSARY	VII
OBJECTIVE OF THE TECHNICAL INVESTIGATION	XIII
SYNOPSIS	XIV
CHAPTER I - FACTUAL INFORMATION	1
1.1. HISTORY OF THE FLIGHT	1
1.1.1. Flight activities and ground operations carried out on the previous day (August 5th, 2005)	1
1.1.2. Research and replacement of the FQI carried out by the maintenance personnel ..	4
1.1.3. Work planning activity for August 6 th , 2005, and planning of the TUI 1153 flight	6
1.1.4. Flight preparation	7
1.1.5. Takeoff from Tunis (flight TUI 152F)	9
1.1.6. Operations carried out at Bari and takeoff for Djerba (flight TUI 1153)	10
1.1.7. The cruise stage and the emergency declaration (MAYDAY)	12
1.1.8. Communications with Palermo approach (APP)	13
1.1.9. Operations inside the cockpit	14
1.1.10. Preparation for ditching	16
1.1.11. Operations inside the passenger cabin	16
1.1.12. The ditching	17
1.2. INJURIES TO PERSONS	18
1.3. DAMAGE TO THE AIRCRAFT	19
1.4. OTHER DAMAGE	20
1.5. FLIGHT CREW AND ATC PERSONNEL INFORMATION	20
1.5.1. Flight crew	20
1.5.1.1. Flight captain (CBD)	20
1.5.1.2. Co-pilot (OPL)	21
1.5.1.3. Flight experience	22
1.5.1.3.1. Flight captain	22
1.5.1.3.2. Co-pilot	22
1.5.1.4. Cabin crew	22
1.5.2. Air traffic controllers	23

1.5.2.1.	Rome area control centre - ACC.....	23
1.5.2.2.	Palermo approach - APP.....	23
1.5.3.	Passengers.....	24
1.5.3.1.	Passengers' evidence.....	24
1.5.4.	The Operator's maintenance personnel involved in the event.....	25
1.5.4.1.	Team leader.....	25
1.5.4.2.	Maintenance engineer who replaced the FQI on the TS-LBB.....	26
1.5.4.3.	Maintenance technician (engineer) on board the aircraft.....	26
1.6.	AIRCRAFT INFORMATION.....	27
1.6.1.	Aircraft technical-operational data.....	27
1.6.2.	General TS-LBB technical data.....	27
1.6.3.	Power plant information.....	28
1.6.4.	Engines and propellers installed on the TS-LBB.....	30
1.6.5.	ATR 72 fuel system.....	32
1.6.5.1.	Description and main characteristics.....	32
1.6.5.2.	The fuel indicator system.....	34
1.6.5.3.	Centralized refuelling mode.....	36
1.6.5.4.	Fuel consumption indicator.....	38
1.6.6.	Electrical system.....	39
1.6.7.	Centralized warning system.....	40
1.7.	METEOROLOGICAL INFORMATION.....	41
1.8.	AIDS TO NAVIGATION.....	42
1.9.	COMMUNICATIONS.....	44
1.10.	AERODROME INFORMATION.....	45
1.11.	FLIGHT RECORDERS.....	46
1.11.1.	Description of the recorders.....	46
1.11.2.	Condition of the recorders.....	48
1.11.3.	Data reading and decoding operations.....	50
1.11.4.	CVR, FDR and ATC data synchronization.....	51
1.11.5.	Significant elements emerged from the analysis of the CVR and FDR.....	53
1.12.	WRECKAGE AND IMPACT INFORMATION.....	56
1.12.1.	Geographical position of the wreckage.....	56
1.12.2.	Recovery of the wreckage.....	57
1.12.3.	Visual inspection on the wreckage.....	58

1.13.	MEDICAL AND PATHOLOGICAL INFORMATION	71
1.14.	FIRE	72
1.15.	SURVIVAL ASPECTS	72
1.15.1.	Search and recovery of the wreckage	72
1.15.1.1.	General considerations	72
1.15.1.2.	Operations carried out by the Italian Navy for the location of the wreckage	73
1.15.1.2.1.	Planning of the operations	74
1.15.1.2.2.	Instruments and techniques used	75
1.15.1.2.3.	Main results.	78
1.15.1.3.	Wreckage recovery operations	79
1.15.1.3.1.	General	79
1.15.1.3.2.	Timing of the operations.	87
1.15.2.	Search and rescue	98
1.15.2.1.	Introduction.	98
1.15.2.2.	Initial actions.	100
1.15.2.3.	Activities performed by the Capitaneria di Porto of Palermo	103
1.15.3.	Injuries suffered by the passengers and their positions on the aircraft	108
1.16.	TESTS AND RESEARCH	109
1.16.1.	Introduction.	109
1.16.2.	Technical analysis of the wreckage, components and systems.	109
1.16.2.1.	Engines assessment.	112
1.16.2.1.1.	Results of the engine inspections	113
1.16.3.	Ground refuelling tests	113
1.16.3.1.	Results of the refuelling tests	116
1.16.4.	Simulation of the search for a replacement FQI.	117
1.16.5.	Aircraft performance check tests	119
1.16.5.1.	ATR calculation programme.	120
1.16.5.2.	Flight simulator tests.	121
1.16.5.2.1.	Main findings	124
1.17.	ORGANIZATIONAL AND MANAGEMENT INFORMATION	127
1.18.	ADDITIONAL INFORMATION	130
1.18.1.	Coordination between the judicial Authority's investigation and the ANSV technical investigation.	130
1.18.2.	Company procedures for fuel management	132

1.18.3.	Ditching.....	132
1.18.4.	Pertinent ATR-72 Non-Standard (Procedures following failure) and Emergency Procedures.....	134
1.18.4.1.	Engine flame out and Single engine operation.....	135
1.18.4.2.	Both engines flame out.....	136
1.18.4.3.	Ditching procedure for the ATR 72.....	137
1.18.5.	Aeronautical technical personnel qualification.....	140
1.18.6.	Maintenance instructions for replacing the FQI.....	140
1.18.7.	Fuel quantity indicator Part Number identification.....	140
1.18.8.	Preventive measures.....	142
1.18.8.1.	ANSV.....	142
1.18.8.2.	EASA.....	144
1.18.8.3.	ATR.....	145
1.18.8.4.	ENAC.....	145
1.18.8.5.	Action taken by the Operator.....	146
1.18.8.6.	Conclusive action.....	147
1.19.	USEFUL OR EFFECTIVE INVESTIGATION TECHNIQUES.....	147
CHAPTER II - ANALYSIS.....		149
2.	GENERAL CONSIDERATIONS.....	149
2.1.	PREPARATIONS FOR THE FLIGHT.....	149
2.1.1.	Quantity of fuel on board the aircraft.....	149
2.1.2.	Considerations.....	152
2.2.	FLIGHT OPERATION AND FAILURE MANAGEMENT.....	153
2.2.1.	Flight TUI 152F (Tunis-Bari, ferry flight) and refuelling operations in Bari.....	153
2.2.2.	Flight TUI 1153 (Bari-Djerba) – Takeoff and cruise phase.....	155
2.2.3.	Cockpit operations analysis – Engines failed.....	157
2.2.4.	Considerations on crew action.....	162
2.3.	FINAL PHASE OF FLIGHT AND DITCHING DYNAMICS.....	167
2.4.	OPERATIONS IN PASSENGER CABIN.....	169
2.5.	CONSIDERATIONS CONCERNING ATR 72 DITCHING PROCEDURE.....	171
2.6.	FAILURE SIMULATION.....	171
2.6.1.	Preliminary remarks.....	171
2.6.2.	Considerations on simulation results.....	172

2.6.3.	Approximate estimation of the theoretical range	173
2.7.	RADIO COMMUNICATIONS	176
2.8.	SEARCH AND RESCUE.	177
2.9.	FUEL SYSTEM AND FQI.	178
2.9.1.	Effects of mounting an ATR 42 type FQI on an ATR 72 aircraft.	178
2.9.2.	Other cases of incorrect FQI replacement	179
2.9.3.	Considerations regarding FQI's identifying Part Number	181
2.10.	ENGINE INVESTIGATIONS	182
2.11.	OPERATOR'S MAINTENANCE PROCEDURES	182
2.12.	CONSIDERATIONS CONCERNING THE RELATION BETWEEN JUDICIAL AUTHORITY INQUIRY AND ANSV TECHNICAL INVESTIGATION	184
2.13.	ANALYSIS ACCORDING TO JAMES REASON'S ORGANIZATIONAL ACCIDENT MODEL	186
2.13.1.	Introduction.	186
2.13.2.	Accident origin and analysis.	187
	CHAPTER III - CONCLUSIONS.	193
3.	CONCLUSIONS.	193
3.1.	EVIDENCE.	193
3.2.	CAUSE AND CONTRIBUTING FACTORS.	198
	CHAPTER IV - SAFETY RECOMMENDATIONS	201
4.	RECOMMENDATIONS.	201
4.1.	INTRODUCTION.	201
4.2.	RECOMMENDATIONS ALREADY ISSUED	202
4.3.	FURTHER RECOMMENDATIONS	202
	LIST OF ATTACHMENTS	208

GLOSSARY

AC:	alternating current
ACC:	Area Control Centre
AFM:	Airplane Flight Manual
AGL:	Above Ground Level
AIP:	Aeronautical Information Publication
AMASIS:	Aircraft Maintenance and Spare Information System
AMI:	Aeronautica Militare Italiana, the Italian Air Force
AMSL:	Above Mean Sea Level
ANSV:	Agenzia Nazionale per la Sicurezza del Volo
AOA:	Angle Of Attack (angle formed by the chordline of the wings profile, with the direction of the air hitting it in flight)
AOC:	Air Operator Certificate
APP:	Approach control office or Approach control or Approach control service
ATC:	Air Traffic Control
ATPL:	Airline Transport Pilot Licence
ATR:	Avion de Transport Régional
ATS:	Air Traffic Services
CAM:	Cockpit Area Microphone
CAS:	Calibrated Air Speed
CAVOK:	ceiling (visibility), cloud and current weather better than prescribed values
CDB:	Commandant De Bord (<i>pilot-in-command</i>)
CC:	Chef de Cabine (<i>senior flight attendant</i>)
CG:	Center of Gravity
CHECK LIST:	list of checks to be performed

CHIME:	acoustic warning
CL:	condition levers
CM1/CM2:	Crew Member 1 (pilot-in-charge or left pilot seat, normally occupied by the pilot-in-command) / Crew Member 2 (first officer or co-pilot)
CMA:	Corda Media Aerodinamica (<i>mean aerodynamic chordline</i>)
CMM:	Component Maintenance Manual
CP:	Capitaneria di Porto, (<i>harbourmaster's office</i>), being part of the Italian coastguard organization
CPL:	Commercial Pilot Licence
CRM:	Compte-Rendu Matériel de l'exploitant
CSO:	Capo Sala Operativo (<i>operations room chief</i>)
CTR:	Control zone, on approach
CVR:	Cockpit Voice Recorder
DC:	Direct Current
DEW POINT:	the temperature at which cooling air condenses
DGAC:	Direzione generale dell'aviazione civile (<i>directorate general of civil aviation</i>)
DME:	Distance Measuring Equipment
EASA:	European Aviation Safety Agency
EGPWS:	Enhanced Ground Proximity Warning System
ELT:	Emergency Locator Transmitter
ENAC:	Ente nazionale per l'aviazione civile (<i>Italian Civil Aviation Authority</i>)
ENAV SpA:	Italian company for air navigation services
FAA:	Federal Aviation Administration (<i>United States of America Civil Aviation Authority</i>)
FCOM:	Flight Crew Operation Manual
FD:	Flight Dispatcher
FDAU:	Flight Data Acquisition Unit
FDR:	Flight Data Recorder

FF:	Fuel Flow
FOD:	Foreign Object Damage
FQI:	Fuel Quantity Indicator
FL:	Flight Level
ft:	feet
FTR:	Feather, (pitch position of propeller giving least drag to forward motion)
FU:	Fuel Used
G/A/G:	Ground/Air/Ground radio communications
GND:	Ground
GS:	Ground Speed
HDG:	Heading
hPa:	hectoPascal, unit of pressure measurement
HPC:	High Pressure Compressor
Hz:	Hertz (unit of frequency measurement)
IAS:	Indicated Air Speed
ICAO/OACI:	International Civil Aviation Organization
IDLE:	position of the engine power levers corresponding to minimum rate
IFR:	Instrument Flight Rules
ILS:	Instrument Landing System
IMC:	Instrument Meteorological Conditions
IMRCC:	Italian Maritime Rescue Coordination Center
IPC:	Illustrated Parts Catalogue
IR:	Instrument Rating
JAA:	Joint Aviation Authorities
JAR:	Joint Aviation Requirements, technical dispositions issued by JAA
kt/kts:	knot/knots, unit of measure being nautical miles per hour

JIC:	Job Instruction Card
lb:	pound (weight)
LH:	Left Hand
LPC:	Low Pressure Compressor
MAC:	Mean Aerodynamic Chord
ME:	Multi Engine
METAR:	Aviation routine weather report
MFCU:	Main Fuel Control Unit
MHz:	megahertz
MIC:	microphone
MMI:	Marina Militare Italiana, the Italian Navy
MRSC:	Marittime Rescue Sub Centre
MSL:	Mean Sea Level
MTOM:	Maximum Take Off Mass
NLG:	Nose Landing Gear
NM:	Nautical Miles
NOTAM:	Notices To Air Men
OPL:	Officier Pilote de Ligne (<i>first officer or co-pilot</i>)
PF:	Pilot Flying, pilot operating the controls
PIC:	Pilot-in-Command, pilot in charge of the aircraft
PL:	Power levers
P/N:	Part Number
PNF:	Pilot Not Flying, pilot assisting the PF
PRS:	radio identification of Palermo TVOR
QNH:	altimeter adjustment for reading the altitude of the airport
QRH:	Quick Reference Handbook
RH:	Right Hand

ROV:	Remotely Operated Vehicle
RWY:	Runway
SIGMET:	aeronautical term defining information regarding weather phenomena along the flight path that could influence flight safety
SO:	Shut-Off
S/N:	Serial Number
T/B/T:	terra-bordo-terra, Italian term for ground-to-air and air-to-ground radio communications
TAS:	True Air Speed
TD:	Technical Department
TRANSPONDER:	aircraft transceiver device allowing linking of the aircraft's radar track to a precise assigned code
TUI:	ICAO code identifying the TS-LBB operator
TVOR/DME:	Terminal VHF Omnidirectional radio Range with DME
TWR:	Aerodrome Control Tower
UG:	IATA code identifying the TS-LBB operator
ULB:	Underwater Locator Beacon
UTC:	Coordinated Universal Time
VFR:	Visual Flight Rules
VHF:	Very High Frequency (from 30 to 300 MHz)
VOR:	VHF Omnidirectional radio Range
VVF:	Vigili del Fuoco, the Italian fire service

OBJECTIVE OF THE TECHNICAL INVESTIGATION

The technical investigation relative to the event concerned, as provided for by Art. 827 of the navigation code, was conducted in conformity with that covered by Annex 13 of the Convention on International Civil Aviation, signed in Chicago on December 7th, 1944, approved and implemented in Italy by legislative decree dated March 6th, 1948, no. 616, ratified by legal Act April 17th, 1956, no. 561 (known also as Annex 13 ICAO).

The Agenzia Nazionale per la Sicurezza del Volo (ANSV), within its field of responsibility, in completion of the technical investigation in question attempted to guarantee observance of those regulatory provisions contained in Annex 13 ICAO that recognize precise rights to certain States. Part of these rights, however, was found to be limited in the light of that envisaged by the criminal procedures system in force, on the occasion of the simultaneous inquiry by the judicial authority.

The Agenzia Nazionale per la Sicurezza del Volo conducts technical investigations within its jurisdiction with ***“the sole objective of preventing accidents and incidents, excluding all evaluation of blame and responsibility”*** (Art. 3, paragraph 1, legislative decree of February 25th, 1999, no. 66).

For every investigation into an accident the Agenzia Nazionale per la Sicurezza del Volo compiles an accident report while, for every investigation into an incident, it compiles an incident report. The accident and incident reports may contain safety recommendations, aimed at the prevention of accidents and incidents (Art. 12, paragraphs 1 and 2, legislative decree of February 25th, 1999, no. 66).

With accident reports the right to confidentiality of those involved in the event is safeguarded as well as of those who provide information in the course of the investigation; in incident reports in addition the anonymity of those involved in the event is safeguarded (Art. 12, paragraph 3, legislative decree February 25th, 1999, no. 66).

“The accident and incident investigation reports and safety recommendations in any cases do not concern the determination of blame and responsibility” (Art. 12, paragraph 4, legislative decree of February 25th, 1999, no. 66).

This report is released in accordance with and under the provisions of legislative decree February 25th, 1999, no. 66, institutive of ANSV.

Copying, distribution or use of this report (totally or partially) for commercial purposes is forbidden.

This report has been translated and published by Agenzia Nazionale per la Sicurezza del Volo for the English-speaking concerned public. The intent was not to produce a factual translation and as accurate as the translation may be, the original text in Italian is the work of reference.

SYNOPSIS

The accident occurred on August 6th, 2005, at 13.39 UTC (15.39 local time) and involved an ATR 72-202 aircraft, registration marks TS-LBB, operating the flight TUI 1153 from Bari to Djerba (Tunisia).

The aircraft had ditched into the sea off the coast of Capo Gallo (Palermo) following the failure of both engines. The aircraft had taken off from Bari at 12.32 UTC with 39 people on board (4 crew members and 35 passengers, among which 1 airline engineer). While cruising, approximately 50 minutes after takeoff, at flight level 230 (FL 230, 23.000 feet), the right engine shut down (no. 2) and after approximately 100 seconds also the left engine shut down (no. 1). The flight crew decided to divert to the airport at Palermo, Punta Raisi, to make a precautionary landing. The crew referred to having tried to restart both engines, but without success. After gliding for approximately 16 minutes, the aircraft ditched approximately 23 nautical miles northeast from Palermo's airport, Punta Raisi, within Italian territorial waters. On impact with the surface of the sea, the aircraft broke into three pieces; 14 passengers, the airline engineer and a member of the crew (senior flight attendant) reported fatal injuries. The other occupants suffered serious to minor injuries.

ANSV was promptly informed of the event by ENAV SpA and ENAC, permitting the investigators to speedily coordinate the initial operations necessary to conduct the technical investigation.

The Agenzia Nazionale per la Sicurezza del Volo, under the terms of governmental decree 66/1999, conducted the technical investigation in conformity with Annex 13 of the Convention on International Civil Aviation (Chicago, 1944). ANSV, within its field of responsibility, in completion of the technical investigation in question attempted to guarantee observance of those regulatory provisions contained in Annex 13 ICAO that recognize precise rights to certain States. Part of these rights, however, was found to be limited in the light of that envisaged by the criminal procedures code in force, on the occasion of the simultaneous inquiry by the judicial authority.

In accordance with the provisions of this Annex 13, the ANSV notified the event to the following foreign institutions responsible, in their respective States, for carrying out the technical investigation:

- Bureau d'Enquêtes et d'Analyses pour la sécurité de l'aviation civile (BEA) – France, as the country where the aircraft was manufactured;

- Tunisian civil aviation authority (DGAC Tunisia), as the country where the aircraft was registered and operated;
- Transportation Safety Board (TSB) - Canada, as the country where the engines were manufactured;
- National Transportation Safety Board (NTSB) – United States of America, as the country where the propellers were manufactured.

These organizations accredited one of their own representatives to assist the Investigator-In-Charge during the course of the investigation, within the limits and in the way set down in the same Annex 13. The Tunisian DGAC, the BEA and TSB, as provided for by Annex 13 ICAO, after having received the draft final investigation report (date sent October 8th, 2007), sent comments for the same final report. No comments were forthcoming from NTSB.

These comments, covering the entire report and the proposed safety recommendations, were closely examined during three meetings held in the ANSV offices on October 24th, 2007, November 25th and 26th, 2007, and December 4th, 2007. These meetings were attended by representatives of the Tunisian DGAC, BEA, ATR (in the role of technical consultants to BEA), the aircraft operator (in the role of the Tunisian DGAC's technical consultant) and other consultants of the same Tunisian DGAC, among them one in the role of their legal expert.

During these meetings ANSV extensively explained to the participants the evidence available to support the analyses made and conclusions drawn. On request, copies of the material available to support the analyses made were provided, in addition to the copies of the material already provided earlier.

As a result of that presented by ANSV, the final comments were formulated for the draft investigation report, and these, as provided for by Annex 13 ICAO, were included as an Appendix to this report.

As soon as it had been notified about the accident, ANSV, as provided in legislative decree 66 of February 25th, 1999 and in Annex 13 ICAO, arranged the requisite coordination with the appropriate judicial and maritime authorities to ensure the proper, prompt recovery of all the evidences required to ascertain the causes of the occurrence.

The event was analyzed not only as a human error by the mechanics/engineers who had researched and replaced the FQI and by the flight crew who, despite having the possibility to be aware of the erroneous replacement, had not undertaken any corrective action, but also as a sum of organizational errors.

All of those involved in the event in various ways were not sufficiently supported by the system in which they worked to prevent the so-called “fatal error”.

Among the factors that contributed to the event we highlight the inaccuracy of the data entered in the spare parts management system (with particular regard to the interchangeability of parts) and the absence of an effective check of that system. The same maintenance and organizational standards of the Operator at the time of the event are not considered satisfactory for an adequate management of their aircraft.

During the investigation three safety recommendations were issued, while another fifteen were issued at the conclusion.

CHAPTER I

FACTUAL INFORMATION

1.1. HISTORY OF THE FLIGHT

1.1.1. Flight activities and ground operations carried out on the previous day (August 5th, 2005)¹

The day prior to the event, the TS-LBB aircraft was used for 5 flight routes (Djerba-Tunis, Tunis-Catania-Tunis, during the morning, and Tunis-Catania-Tunis, during the early afternoon). More specifically, the same flight captain later on involved in the accident had also completed the last four flight routes. These were properly recorded in the aircraft's log book (Performance Record: section on completed routes and quantity of fuel tanked and consumed; see figures 1 and 2). On the other hand, the co-pilot involved in the event had completed the last two routes. The aircraft was refuelled twice in Tunis during the same morning, with 1560 kg (flight TUI 172) and 1600 kg (flight TUI 1140) respectively; these operations have been duly recorded in the Performance Record (figure 2). The fuel remaining after the first route, Djerba-Tunis, was 770 kg, as shown in the "REMAINING F" box (figure 2).

R E W		CAPT STAFF NBR & SIGN		PERFORMANCE RECORD ALL AIRCRAFT				LOG NBR № 075635			
		A/C TYPE ATR72		A/C REG TS-LBB		D D M M Y Y DATE 05 08 05					
LEG	FLT NBR	DEP	ARR	OUT UTC	OFF UTC	ON UTC	IN UTC				
1	172	TUN	CTA	07 05	07 10	08 05	08 10				
2	173	CTA	TUN	09 15	09 20	10 35	10 40				
3	1140	TUN	CTA	11 15	11 20	12 20	12 25				
4	1141	CTA	TUN	13 55	14 00	15 10	15 15				
5											
6											

Figure 1: Flights completed on August 5th, 2005 by the TS-LBB aircraft with the same flight captain flying the TUI 1153.

¹ Unless otherwise indicated, the times stated in the report are in UTC, corresponding to the local time less two hours.

	TOTAL FUEL	FUEL USED 1	FUEL USED 2	FUEL USED 3	FUEL USED 4	TOTAL USED	REMAINING F	ADDED FUEL
1	2290	321	330			650	770	1560
2	1630	410	420			830	770	1600
3	2260	322	338			660	1670	✓
4	1670	404	410			814	790	
5								
6								

Figure 2: Section of the Performance Record's page showing refuelling operations and fuel quantities.

During the first route, Tunis-Catania, the flight captain had become aware of the inefficiency of the fuel quantity indicator (FQI); in particular, the value shown by the FQI for the right-hand tank was not normal: some LEDs of the display were not working, which meant that the fuel quantity was not correctly displayed. In photo 1 it's in fact possible to see the lights of the right display that were not working correctly: the one for the thousands, and the one for the units. The FQI provides the crew with the value of the fuel quantity, in kg or in pounds, depending on the aircraft model, inside the wing fuel tanks. Further details on how this instrument works are outlined in the following paragraph 1.6.5.2.



Photo 1: The FQI installed on TS-LBB before replacement.

At the end of the fourth route, flight TUI 1141 from Catania to Tunis, the captain recorded the inefficiency of the right wing fuel tank fuel indicator in the section for recording faults of the aircraft's log book (figure 3), as required by the airline's procedure.

FLT NBR	STA	A/C TYPE	A/C REG	D	D	M	M	Y	Y	SEQ	S/N OFF	P/N OFF
1141	DN	ATR72	ISLUBB	05	05	08	08	01	01	4	179	748681-2
SUBJECT: INSTRUMENT No 068297											ACTION TAKEN: Replace fuel qty	
COMPLAINTS: FUEL QTY INDICATOR R.I.K. ERROR											Indicator error ok	
CREW IDENT											OIL REFILLING US QUAR	
ATA NBR											HINES RELEASE	
FIRM CODE											SIGN	

Figure 3: Part of the aircraft's log book page showing the recording of the faults.

The same evening the FQI was replaced. In particular, the faulty FQI, P/N 748681-2, S/N 179 was removed and replaced with FQI P/N 749-158, S/N 238, which is however an FQI intended for an ATR 42 type aircraft, and with a mode of operation and characteristics different from the model for the ATR 72 aircraft, although the installation procedure is the same.

The following paragraph 1.1.2 shows in detail the operations completed by the technicians involved in the replacement of the part.

The FQI is an instrument processing the signal from the capacitive sensors installed in the wing fuel tanks, based on an algorithm, which is specific to each type of aircraft, depending on the shape of the tanks, their sizes and the number of probes. The wing fuel tanks of ATR 42 and ATR 72 aircraft are different in terms of maximum capacity, shape, number and positioning of the capacitive probes. Therefore, ATR 42 and ATR 72 type FQIs use different algorithms and cannot be interchanged. As we will ascertain later on, the fuel quantity indications provided by an ATR 42 type FQI, mounted on an ATR 72 aircraft, are higher than the actual quantity of fuel contained in the wing fuel tanks.

In accordance with the removal and installation procedure (Job Instruction Card Removal And Installation, JIC-RAI) applicable at the time, the replacement procedure did not require any manual checks, using the so-called dripsticks, of the actual quantity of fuel present in each tank, or the subsequent comparison with the value shown by the FQI.

After the maintenance interventions were completed, the aircraft was therefore again efficient, and the quantity of fuel on board as shown on the Performance Record, was 790 kg. But, with the replacement of the FQI with an ATR 42 type, the indication was, indeed, equal to 3050 to 3100 kg (the sum of the quantity shown for the two wing fuel tanks).

1.1.2. Research and replacement of the FQI carried out by the maintenance personnel

As highlighted in the previous paragraph, during the first route Tunis-Catania, the crew had become aware of the inefficiency of the lights of the right display of the FQI. After arriving in Tunis, the flight engineer on board the plane during the first two routes, Tunis-Catania-Tunis, carried out a research for a replacement FQI, so that this could be replaced when the aircraft would return from the last flight of the day.

He therefore checked using a video terminal the electronic Illustrated Parts Catalogue (IPC - which is the only reference document for the operators), supplied by the aircraft manufacturer, and identified three Part Numbers (P/N) corresponding to the FQI to be replaced, all suitable to be fitted on ATR 72 aircraft:

- 748-681-2;
- 749-160;
- 749-759.

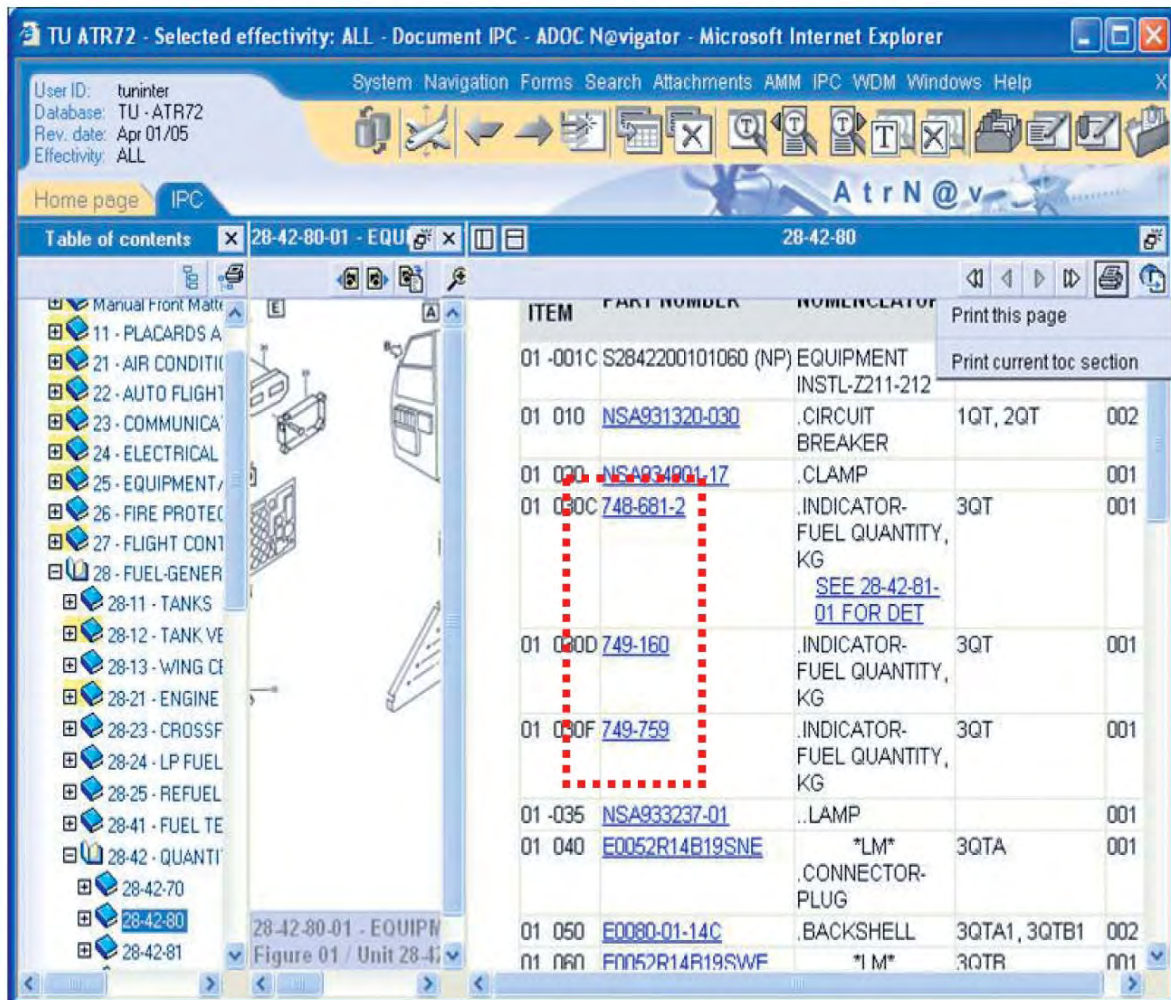

Figure 4: IPC video screen.

The technician checked the situation for the FQIs marked with one of the three P/Ns applicable to the ATR 72 aircraft, either available in stock or installed on one of the Operator’s aircraft, by searching through the spare parts management system (®AMASIS) used by the airline, using a different dedicated video terminal.

The research gave negative results as none of the FQIs identified with either of the three applicable P/Ns was recognised by the spare parts management system. As it will be possible to see later on, those parts were not unavailable, but rather, the FQIs covered by those P/Ns had not been entered in the database used by the spare management system.

As this result was rather strange, considering that at least the FQIs already installed on the aircraft of the carrier should have shown on the information system, the technician tried to look for FQIs recorded with a P/N different from the one listed in the IPC; the technician started a new database search entering only the first three digits of the P/N, followed by a dash (“748-”), then scrolling through the list looking for any FQI suitable for installation on ATR 72 aircraft. With this method and following the search procedure of the ®AMASIS system, the technician was able to find the part called “IND QTE CARB”, identified with P/N 748-465-5AB, which the system showed as suitable to both ATR 42 and ATR 72 aircraft, and also interchangeable with FQI P/N 749-158.

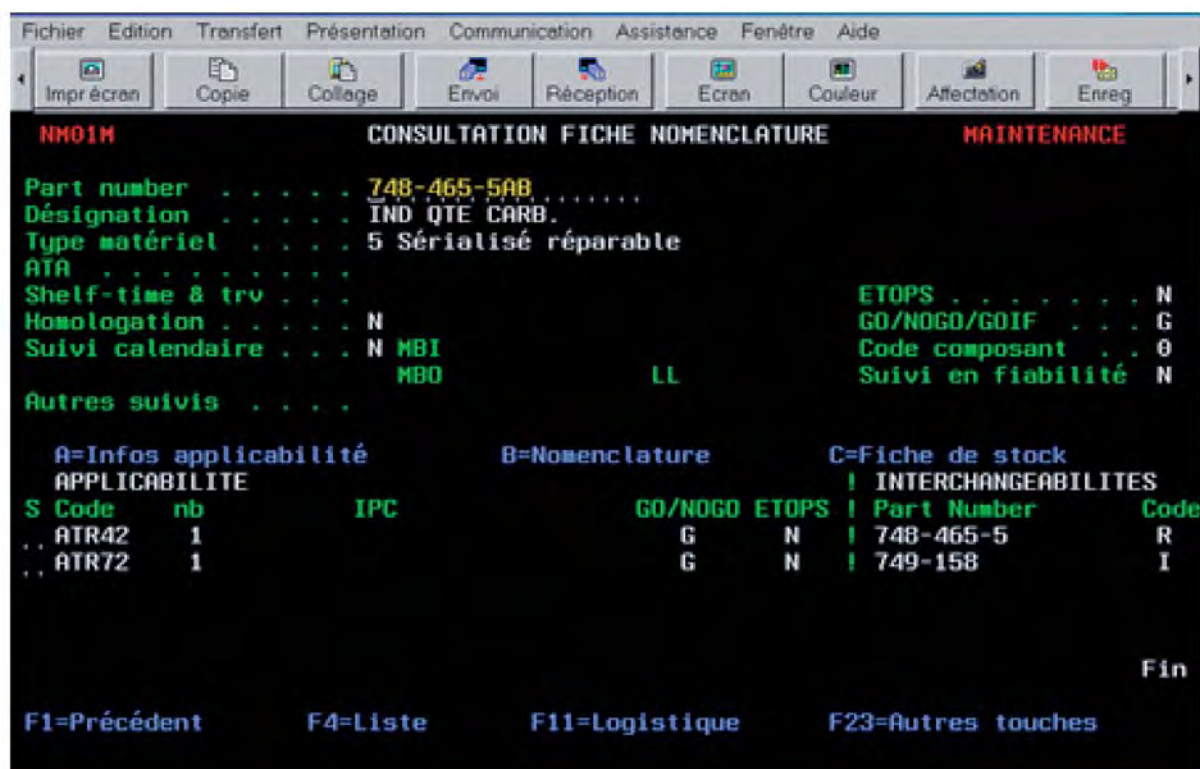

Figure 5: Screen information provided by ®AMASIS.

In the section “APPLICABILITÉ” (bottom left of figure 5), the “Code” field indicates in fact the type or the family of aircraft on which the part can be installed, the “nb” field shows the quantity needed on each aircraft and the IPC code in the ®AMASIS video should give the chapter, page, section and figure of the IPC where the part is listed. In the section “INTERCHANGEABILITÉS”, at the bottom right of figure 5 are listed the P/N of other interchangeable parts, while the field “Code” shows any restrictions (“I” means full interchangeability, “R” means interchangeable but with restrictions imposed by the manufacturer).

The information relating to the applicability was wrong as P/N 748-465-5AB identifies an FQI only applicable to ATR 42 aircraft, and not also to model ATR 72.

The technician continued his search, checking the availability of an FQI identified by one of the three P/Ns (748-465-5AB or 748-465-5 or 749-158).

He was able to find that an FQI P/N 749-158, S/N 238 in good working order was available from the store in Tunis. The technician therefore filled out the collection note for the part, which he then collected from the store. Having finished his shift, he left the part, ready to be installed, to his colleague taking over after him.

The technician, responsible for replacing the part, removed the faulty FQI P/N 748681-2, S/N 179 from TS-LBB and replaced it with the P/N 749-158, S/N 238 indicator, following the detailed instructions of the Job Instruction Card JIC 28-42-81 RAI 10000 (procedure set by the ATR manufacturer for the replacement of the part, see Attachment “C”), which did not require any checking on the correctness of the information provided by the device, but only the testing of the lights of the display after fitting.

The technician replacing the part did not complete, however, an IPC check for the applicability of part P/N 749-158 to the ATR 72 aircraft, neither before nor after the replacement.

1.1.3. Work planning activity for August 6th, 2005, and planning of the TUI 1153 flight

The Bari-Djerba flight (TUI 1153) of August 6th, 2005, was part of a set of four charter flights requested on August 1st, 2005, by a tour operator to the operator of the TS-LBB. The following day the carrier confirmed their availability to complete the flights, and included both the ferry flight from Tunis to Bari and the flight from Bari to Djerba in the work activity plan of August 6th, 2005. Specifically, the flight plans for the TS-LBB aircraft for August 6th, 2005, included the following routes:

- Tunis–Djerba, at 06.30 UTC, flight UG 002, with 70 passengers expected on board;
- Djerba–Tunis, at 08.30 UTC, with 60 passengers expected;

- Tunis–Bari at 10.00 UTC, ferry flight TUI 152F (UG152F), which would have a maintenance engineer on board, as per the operator’s instructions in case of operations at airports without ground technical assistance;
- Bari-Djerba, at 12.30 UTC, flight TUI 1153, with 46 passengers expected;
- Djerba–Cagliari, at 15.30 UTC;
- Cagliari–Djerba, at 17.45 UTC;
- Djerba–Tunis, at 19.45 UTC.

1.1.4. Flight preparation

The first two flights planned for August 6th, 2005, for TS-LBB were not completed using this aircraft due to the reasons outlined below.

During the planning stage, the crew for the first flight (UG 002 TUN-DJB Tunis-Djerba), communicated the quantity of fuel needed to complete the route to the Flight Dispatcher (FD) in charge for preparing the loading sheet, as equal to 1400 kg of Block Fuel (fuel which must be on board of the aircraft before start up and subsequent taxiing). The Flight Dispatcher then proceeded to coordinate the request for the tanker to refuel the aircraft.

According to the procedures of the operator, refuelling of aircraft is always carried out in the presence of an airline engineer assisting the refuelling company operator in completing the routine operations. The engineer will specifically open the refuelling door in the fuselage, pre-set the total quantity that must be on board (the Block Fuel value received by the FD), ensure that the static pressure ports are connected to the ground and witness the refuelling operations themselves, ensuring that they are carried out in safe conditions. At the end of refuelling the refuelling slip is issued. This is countersigned by the engineer. The engineer is in charge of handing the slip to the crew, who will enter it in the official flight documentation (in this specific case a blue folder containing all technical-operating information of the flight).

In this particular case, refuelling did not take place because the Block Fuel request (1400 kg) was lower than what was actually indicated by the flight instruments (by the FQI and by the repeater placed on the refuelling panel). In fact, the quantity indicated was approximately 3100 kg. A refuelling slip was therefore filled out, stating that the refuelling operation had not been completed because the quantity of fuel present in the aircraft was higher than required. This was done to justify moving the tanker from the fuel yard area. This solution complied with the current procedures being implemented.

The engineer then told the FD that the quantity of fuel shown was approximately 3100 kg. The

FD therefore informed the crew of the TUN-DJB route that approximately 3100 kg of fuel were in the aircraft and defueling was therefore necessary. As the specific defueling tanker would only be available in approximately two hours, in order to avoid any delays to the flight, the FD suggested to the crew that another ATR 72 aircraft be used for this route, TS-LBC coming from Djerba, which had just landed. During normal activities, it would be the ground operations manager that decides/suggests any aircraft changes, but as he was not in the airport at the time, the FD was able to propose such a change of aircraft.

In order to avoid any delays, the crew agreed to complete the TUN-DJB flight with TS-LBC.

In the meantime, the crew for the UG 1148 flight from Tunis to Palermo, which should have been completed using TS-LBC, was informed of an aircraft change, which meant that TS-LBB would be used instead. While waiting for the arrival of the flight captain, the co-pilot of the UG 1148 flight ascertained, both through the refuelling panel and the FQI installed on board, that the quantity of fuel communicated by the FD was not exactly 3100 kg, but rather 3150 kg. After about 10 minutes the flight captain arrived and, after checking the maintenance section of the aircraft technical documentation, refused to use this aircraft (TS-LBB). He took this decision because during previous flights using the same aircraft, a malfunctioning of the Nose Wheel Steering (NWS, a system that enables controlling the steering of the aircraft when on the ground) had repeatedly been notified. It was his opinion that this fault had not been correctly handled and resolved. The NWS was not inefficient, but in the past had shown functionality problems when at maximum travel (excess vibrations on the control, together with a loud and irritating noise). Such notifications had been made by the same flight captain. In accordance with company procedures, he recorded the reasons for the refusal of the aircraft on the aircraft technical documentation. In turn, the ground engineer wrote on the maintenance logbook that the NWS problem would be resolved the following week, with the intervention of a specialist engineer from the company Hydrep, the NWS manufacturer. It must be pointed out that the flight captain confirmed that he only checked the aircraft's technical efficiency status and also that he did not check the fuel documentation.

The FD therefore proposed to the flight captain that the Tunis-Palermo (TUN-PMO) route be completed with a replacement aircraft, an ATR 42 (TS-LBA). After checking the load sheet and the number of expected passengers (18), the flight captain agreed to this proposal. The first two flights planned for TS-LBB (Tunis-Djerba-Tunis) were therefore not completed using this aircraft.

1.1.5. Takeoff from Tunis (flight TUI 152F)

The TS-LBB aircraft was still stationed on the apron and was available for the following ferry flight to Bari (TUI 152F), scheduled for 12.00 local time. The flight captain in charge was the same who had completed the last four routes the previous day, using the same aircraft.

At 10.00 local time the FD contacted the flight captain by phone to ask if the quantity of fuel of 3100 kg indicated would be enough to complete the expected route or if refuelling would be necessary. The flight captain answered that he would only take the final decision once at the airport, after checking in detail the operation documents.

At approximately 11.00 local time the co-pilot arrived at the airport and started to prepare the operation documents needed for the flight. The flight captain, already at the airport, informed him that on board were approximately 3100 kg of fuel, as per the telephone communication received from the FD. On the basis of the operational information, the co-pilot pre-calculated that in order to complete the ferry flight to Bari and the following flight to Djerba without refuelling at Bari, the quantity of fuel needed would be 4200 kg. He passed on this information to the flight captain during the pre-flight briefing. The flight captain, responsible for the final decision, decided to request a Block Fuel value of 3800 kg. During the interviews carried out, the flight captain justified this decision with possible route shortenings, which are often allowed due to low volumes of traffic. It was his intention, in accordance with the company procedures, not to refuel the aircraft once it reached Bari to complete the subsequent route Bari-Djerba (flight TUI 1153). The estimated quantity of fuel for the Tunis-Bari route was in fact 1100 kg and therefore the aircraft would have left Bari with 3800 minus 1100 kg = 2700 kg indicated.

The definitive fuel quantity was therefore communicated by the co-pilot to the FD for the preparation of the load sheet and the coordination of refuelling. The instructions were to refuel up to 3800 kg². While on the ramp, the FD therefore asked the operator to carry out the refuelling operation, which was completed at 11.30 local time. The airline engineer assisting the operator in charge of refuelling set the quantity of 3800 kg on the panel and 465 kg, equal to 600 litres were pumped into the aircraft. These values were duly recorded, as per the procedure, in the refuelling slip. A copy of the refuelling slip was given to the engineer, to be handed over to the flight captain.

Once the total fuel quantity which must be present in the aircraft has been entered using the relevant selector on the panel, refuelling is automatically stopped by the aircraft system by means of the refuelling valves. This means that once the FQI establishes that the quantity of fuel in the aircraft is equal to the quantity selected, refuelling will automatically stop.

² As expected, it was not requested that 700 kg be refuelled into the aircraft (difference between the Block Fuel of 3800 kg and 3100 kg, the quantity already indicated by the FQI), but only that the Block Fuel should be 3800 kg.

Neither the refuelling operator, nor the engineer realised that instead of the 700 kg (approximately 900 litres) that should have been pumped into the aircraft (from 3100 to 3800 kg), only 465 kg (600 litres) were in fact pumped.

Once refuelling was complete, the co-pilot completed the pre-flight operations and the flight captain checked the aircraft flight documentation assisted by the FD. In checking the previous refuelling operations carried out on the aircraft, the flight captain realised that the fuel slip for the refuelling of the aircraft from the quantity of 790 kg (the total fuel remaining after the last flight of the aircraft and recorded by himself the previous day in the Performance Record) to 3100 kg, the value indicated by the FQI before refuelling up to 3800 kg, was missing.

The FD asked his colleague in the office if he had a copy of this slip. The answer was negative. The supervisor of the ramp engineering services was also contacted by phone by the FD, and he indicated that he was not aware of such an operation. The FD therefore informed the flight captain that at the moment he was not certain where the fuel slip (from 790 kg to 3100 kg) was, but that it was highly likely that one of the crews planning to complete the previous routes, subsequently cancelled, might have mistakenly kept the copy of this refuelling slip. The FD therefore reported to the flight captain that he would take charge of obtaining the missing fuel slip, which he would have handed to him upon return from the flight.

The flight captain decided to complete the flight with the documentation for the refuelling he had requested, but without the one confirming the previous refuelling operation from 790 kg to 3100 kg, on the basis of the information received by the FD.

In situations of unclear or missing documentation occur, the flight captain should inform the Flight Operations Director. In this case it was not done. The co-pilot stated that the flight captain had not involved him in this problem.

The ferry flight to Bari (TUI 152F), with two pilots, the two flight attendants³ and the maintenance engineer⁴, was completed uneventfully. The aircraft took-off at 12.05 local time (10.05 UTC) and landed at Bari at approximately 13.46 local time (11.46 UTC). The duration of the flight was therefore 101 minutes, in agreement with the distance flown.

1.1.6. Operations carried out at Bari and takeoff for Djerba (flight TUI 1153)

According to the information received by the crew, upon arriving at Bari, the quantity of fuel indicated on the aircraft was approximately 2300 kg. The total quantity planned before leaving

³ In detail, there was a male attendant covering the role of senior flight attendant, assisted by a female flight attendant. To simplify the report, in the following sections they will be identified respectively with the following terms: senior flight attendant and flight attendant.

⁴ According to that stated by the operator, the presence of an engineer on the aircraft is requested when no ground technical assistance from airline personnel will be available at a destination, as was the case for Bari Airport.

for the following route Bari-Djerba was 2700 kg, as indicated by the load and balance sheet of the flight in question (Attachment “F”). The flight captain therefore decided to refuel the aircraft up to 2700 kg. At approximately 13.55 local time the aircraft was refuelled with 265 kg, equal to approximately 340 litres, using the centralized refuelling panel, which was programmed by the aircraft engineer for a total quantity of 2700 kg. As already indicated, the logic of the centralized refuelling system is such that when the fuel indicator (FDI) detects the total quantity previously entered in the panel, the refuelling valves automatically close so that only the programmed quantity is in the wing fuel tanks. Although the quantity pumped into the aircraft was only 265 kg, the total value indicated was still 2700 kg, equal to 400 kg more than that shown by the FQI after landing (2300 kg).

The fact that instead of the 400 kg planned, only 265 kg were actually refuelled in the aircraft (value indicated in the refuelling slip), was not picked up by the flight crew or the engineer.

The difference between the quantity of fuel actually refilled (265 kg) and the quantity resulting from reading the FQI [400 kg, equal to the difference between 2700 kg (the value indicated after refuelling, and 2300 kg, the value before refuelling)] was due to the fact that the installed FQI was an ATR 42 type FQI, which would indicate in fact levels higher than the actual quantity of fuel present, as will be outlined in the following paragraph 1.16.3.1.

Once the refuelling operations were completed, passenger boarding (34) took place, they arrived at the aircraft’s apron area with a vehicle of the Aerodrome Management Company. Once the boarding operations were completed, at 12.19 UTC (14.19 local time), permission to start the engines was requested to Bari air traffic control. Three minutes later permission for taxiing was requested.

The TS-LBB had previously received the information concerning the runway to use and the significant meteorological conditions (runway to be used 07, wind from 360° with intensity 16 knots, outside temperature 25°C, dew point temperature 12°C and QNH 1010 hPa).

At 12.25, from its waiting position for runway 07, TS-LBB, radio (call sign) TUI 1153, received the necessary authorization for completing the flight (destination DTTJ⁵ via TOPNO 6C, [omissis], authorised for initial flight level (FL) of 120⁶, transponder code 3730).

⁵ ICAO code to identify the Djerba Airport.

⁶ FL 120 is equivalent to an altitude of 12.000 ft with QNH 1013 hPa.

At 12.30.31, TS-LBB received the authorization for takeoff, which then took place at approximately 12.32. The flight captain took the role of Pilot Flying (PF)⁷, assisted by the co-pilot, who took the role of Pilot Not Flying (PNF)⁸.

1.1.7. The cruise stage and the emergency declaration (MAYDAY)

The takeoff operation and the subsequent climb to cruising altitude were completed properly.

At 12.34.55 TUI 1153, reaching approximately 7000 ft, contacted the Brindisi Area Control Centre (ACC) to request authorization to climb to flight level (FL) 190. This was granted. At 12.49.40 TUI 1153 requested to increase its altitude up to FL 210 and Brindisi ACC responded with an instruction to changing radio frequency and to contact Rome ACC. At 12.50.20, at FL 190, TUI 1153 contacted Rome ACC requesting FL 210. This was granted.

Subsequently, at 13.01.46, TUI 1153 requested FL 230, the final cruise flight level. This was also granted.

At 13.17.03 TUI 1153 received authorization to proceed directly to waypoint TUPAL, maintaining FL 230, as per the request previously made.

At 13.21.36 (approximately four minutes since the previous radio communication), TUI 1153 requested permission to descend to FL 170 due to technical problem (the PNF did not specify to air traffic control the type of problem occurring).

From the analysis of the data recorded by the FDR, it appears that in fact the right engine had shut down by itself (uncommanded shut down).

Due to other traffic presence, Rome ACC did not authorise the aircraft to descend directly to the requested flight level (FL 170), but gave initial authorization to descend to FL 190. At 13.23.00, after approximately two minutes, TUI 1153 communicated that they wanted to land at Palermo. By now also the left engine had shut down, approximately 100 seconds after the first one (data taken from FDR).

In giving authorization to descend to FL 170, Rome ACC asked if special assistance was needed. This communication overlapped with the previous one of TUI 1153 and was not understood by the crew. TUI 1153 transmitted the MAYDAY declaration (emergency condition declaration), confirming the need to proceed for Palermo.

The controller in contact repeated the authorization to descend to FL 170, confirming receipt of the emergency message, and at the same time coordinating the management of other traffic, to

⁷ Pilot Flying – PF: this is the handling pilot who, irrespective of hierarchical position on the aircraft, has the duty of flying the aircraft, both manually and using the autopilot.

⁸ Pilot Not Flying – PNF: this is the other handling pilot, who assists the PF by controlling the progress of the flight and immediately announcing any anomalies detected. He collaborates with the PF during all stages of the flight, carrying out any operations that are complementary to the flight, such as radio communication with the air traffic control units.

enable the TUI 1153 to proceed directly for Palermo.

At 13.24.19, TUI 1153 transmitted once more the MAYDAY declaration, asking to be vectored (to receive radar guidance) for Palermo and confirming they had lost both engines (“*We lose both engines*”).

The Rome ACC controller did not provide the information requested to TUI 1153 regarding the vectoring for Palermo, but instructed instead that Palermo be contacted on frequency 120.2 MHz, so that they could receive the instructions for landing. In fact, due to the characteristics of the radar position, he would not have been able to provide suitable support for the final stage of the landing at the Palermo airport.

While in radio contact with the aircraft, Rome ACC had also repeatedly contacted Palermo approach (Palermo APP), to inform that the ATR 72, flight TUI 1153 had declared an emergency condition and it was therefore necessary to coordinate the management of other traffic present.

On the basis of the phone transcript, it appears that Rome ACC had informed Palermo that the ATR 72 had declared an emergency due to technical conditions, without specifying that both the engines of the aircraft had failed. It was the same TUI 1153 when contacting Palermo APP, to inform that they were in an emergency condition and that both engines had been lost.

1.1.8. Communications with Palermo approach (APP)

At 13.25, TUI 1153 contacted Palermo APP for the first time and received information on the meteorological conditions at the Palermo airport. They were also requested for confirmation of the emergency condition. In confirming this emergency, TUI 1153 repeatedly asked, three times (the controller had not perfectly understood the question, made in English), the distance to the airport.

The controller finally replied that the current distance from the TVOR-DME of Palermo “PRS” (located on the airport) was 48 nautical miles (NM).

The aircraft, with two engines shut down, was at an altitude of approximately 15.000 ft.

In view of the distance from Palermo in relation to the altitude, the crew of the TUI 1153 asked if there was any other terrain closer than Palermo on which they could land (“*Is there any terrain nearest than Palermo Sir, please? We lose both engines and we are only 15.000 ft*”), pointing out that they had lost both engines and were only at 15.000 ft of altitude. The same request was repeated once more (“*Any nearest airport where we can land?*”) because the controller could not understand its content. At this point, another aircraft intervened via radio, clearly listening on the same frequency (120.2 MHz), repeating (through a so called “bridge” transmission) the

same request made earlier by the TUI 1153 regarding the presence of another airport nearer than Palermo. Palermo APP understood then the request and confirmed that Palermo was in fact the airport closest to their current position.

A series of communications then took place, during which TUI 1153 requested the distance to Palermo and radar vectoring, for an attempt to land on runway 20 of the same airport.

At 13.31.52 Palermo APP requested information on the number of passengers on the aircraft, the fuel load and the presence of any dangerous goods.

TUI 1153 confirmed that there were 35 passengers, the fuel quantity was equal to “1800” (this quantity is to be understood as in kg, as it was the information shown by the FQI, 900 kg for the left tank and 900 kg for the right tank), and that there were no dangerous goods on board.

At 13.33.53 Palermo APP informed that the distance was 20 NM and 15 seconds later TUI 1153 declared that they would not be able to reach mainland and that their current altitude was 4000 ft. They also requested that emergency services be dispatched (“ [omissis] *Can you send us helicopters or something like that?*”). From the FDR data it was estimated that the aircraft was at an altitude of 4000 to 4500 ft.

Palermo APP informed the aircraft that the emergency services had been alerted and gave the radial value and the TVOR/DME distance from Palermo (“*Radial 036°, 22 miles*”). After approximately 90 seconds the TUI 1153 informed to have seen two boats (“*there are two boats*”) and that they had decided to turn left onto heading 180°, in order to ditch as close as possible to them. He also confirmed that their altitude was 2200 ft.

A minute later TUI 1153 confirmed again that they were unable to reach the runway and that they wanted to ditch near the two big boats (“*we have two boats on the left-hand, big boats*”) that they could see on their left. TUI 1153 also asked Palermo APP to inform the two boats of the situation.

Palermo APP answered that the emergency services were alerted (“*We advice military*”).

The communication with Palermo APP ended at approximately 13.37.

1.1.9. Operations inside the cockpit

This paragraph describes the operations carried out inside the cockpit from the moment the first failed occurred until ditching, on the basis of the information gathered from the aircraft recorders FDR/CVR and from the declarations of the pilots.

From taking-off from Bari until the shut down of the first engine (right-hand engine) approximately 49,50 minutes passed, and both the operations inside the cockpit and the communications with the involved air traffic control units (Bari TWR, Brindisi ACC and Rome

ACC) were carried out normally, without any communications of faults.

After the right-hand engine shut down, while at flight level FL 230 (23.000 ft), TUI 1153 requested to descend to FL 170. In the meantime the crew was trying to understand, based on the visual and acoustic warnings inside the cockpit, why the right-hand engine had suddenly shut down. In fact, the “FEED LO PR” light had come on (fuel feed low pressure), together with a decrease of the engine torque, the flowmeter and the “ITT” temperature, all indicating an uncontrolled shut down of the right-hand engine. After coordinating the descent to FL 170 with Rome ACC, the co-pilot started reading out loud the check list (*Procedures following failures* – page 2.13 of the QRH) for the procedure to follow for the type of failure detected (FEED LO PR). During the reading of the relevant check list, approximately 100 seconds after the right-hand engine shut down, the flight captain requested that the co-pilot stop reading, because also the other engine (left) had shut down. He then ordered the co-pilot to inform air traffic control of the decision to divert the aircraft to Palermo, Punta Raisi, and declare the emergency (MAYDAY). For about a minute the pilots tried to interpret the indications of the cockpit instruments warnings and identify the reasons for the failure of both engines, but unsuccessfully. The flight captain communicated again the MAYDAY to Rome ACC, informing them at the same time that both engines had failed (“[omissis], *we lose both engines*”). The aircraft was at an altitude of approximately 17.000 ft.

The flight captain asked the senior flight attendant to call the airline engineer to the cockpit. A minute later the engineer, who had been sitting in the rearmost passenger row, entered the cockpit and took up position between the two pilots, attempting to assist in restarting the two engines.

Some attempts to restart the engines were made, but unsuccessfully. In consideration of the distance from Palermo airport, given several times via radio by Palermo APP, the flight captain, upon comparing this distance with the altitude, called the senior flight attendant and asked him to prepare the passengers for a possible ditching. Five minutes and thirty seconds had passed from the moment the second engine had shut down, and the aircraft was now at an altitude of 12.000 ft and at a distance slightly less than 40 NM from Palermo airport. Both the flight crew and the engineer were unable to understand what type of fault had occurred to the two engines. The distance from Palermo was repeatedly requested and after a last attempt, unsuccessful, to restart the right-hand engine, with the aircraft at an altitude of 4000 ft and at a distance of 20 NM from Palermo airport, the flight captain informed the ATC controller that they were unable to reach the runway and requested that the emergency services be dispatched. Twelve minutes had passed from the time both engines had shut down.

1.1.10. Preparation for ditching

A few seconds after informing Palermo APP that the aircraft was unable to reach the runway, the flight captain asked the co-pilot to read the ditching procedure check list. The flight captain continued to carry out his role of PF, while the co-pilot read the ditching check list. In the meantime, the flight captain informed ATC that he was unable to reach the airport and wanted to go left onto heading 180°, as he could see two boats (“*there are two boats, I am going to join them left side, heading 180*”), and asked if it would be possible to inform the boats of the situation. The co-pilot continued to complete the checks listed in the ditching check list, including those for the landing gear and confirming its retracted position (“*Landing Gear: UP*”). The flight captain, in view of the imminence of the ditching, asked the co-pilot to assist him in the steering of the aircraft and to get ready for the impact. The ditching check list was not completed. A little before the impact, the captain also recommended the engineer, who had remained in the cockpit, to also get ready. After 22 seconds the aircraft impacted on the sea surface.

Nearly 17 minutes had passed from the moment the first engine had shut down, to the ditching. The last valid data recorded by the flight data recorder (FDR) was at 13.37.08⁹. The last recordings of the noises and sounds inside the cockpit (CVR) were at 13.38.05, approximately one minute after, and coinciding with the effective time of ditching. In the following paragraph 1.11.4. the times of some significant events will be specified in detail.

1.1.11. Operations inside the passenger cabin

From taking off at Bari and until the flight captain had requested the senior flight attendant to get ready for ditching, all operations in the passenger cabin had been carried out normally. Fifty-five (55) minutes had passed since the aircraft had taken off, and with both engines failed, it was descending at an altitude of 12.000 to 12.500 ft, at a distance of slightly less than 40 NM from Palermo airport. The senior flight attendant asked the passengers to wear their life jackets, with the flight attendant assisting some of them, according to what she said herself, to put them on. Before the ditching all passengers, including the flight attendants, were sitting with their seatbelts fastened and ready for collision although, in effect, there had previously been some moments of agitation, due to the fact that some passengers were unable to fasten their life jackets, while others, as also shown in the paragraph 1.5.3.1., had actually inflated them already, while inside the aircraft.

⁹ The time can be referred to the UTC time of the G/A/G communications of Palermo APP.

1.1.12. The ditching

As already stated in the previous paragraph 1.1.10., the CVR continued to record until the impact with the water which indicates that the main battery was still working. The FDR, which is powered by the same main battery of the CVR stopped the recording approximately one minute before the ditching. This could indicate that this equipment was less tolerant to the decrease of current tension due to main battery about to be exhausted.

The attempts to restart the engines may have partially exhausted the main battery. However the CVR continued to work¹⁰.

The latest values of the significant parameters recorded by the FDR (time: 14988 seconds) were the following:

- Altitude: 728 ft.
- Speed: 125 kts (calibrated speed).
- Pitch attitude: 4,2°. This is the angle between the longitudinal axis of the aircraft and the horizon.
- Angle of attack: 10,2°.
- Roll angle: - 2.1° (slight inclination to the left).
- Heading: 111°.
- Vertical acceleration: 0.96.

Just before the aircraft impacted with the sea surface, the CVR recorded an intermittent sound, typical of the acoustic stall warning for an aircraft stall condition approaching.

From the interview with the surviving occupants and from that reported by the rescue personnel, the following was also established:

- Although broken in three main parts, the aircraft remained floating on the water's surface for about 20 to 30 minutes after ditching; after this time the front and rear sections sank, while the central section of the fuselage, with the LH and RH wings and the two engines, remained floating.
- Immediately after the first collision, the rear fuselage section became partially detached from the rest of the structure and was partially submerged by the water. Almost all passengers seating in the corresponding seats survived.

The geographical co-ordinates of the presumed position of the floating wreckage were as follows:

- Latitude 38° 24'29" N.
- Longitude 013°30'31" E.

¹⁰ The FDR and CVR are fed by the same ESS bus bar (i.e. main battery). The FDR may have not put up with/handled the voltage decrease.

These correspond to the co-ordinates communicated by radio from the control tower to an airliner that took-off from Palermo airport (20 minutes after the ditching itself), with the aim of carrying out a first visual reconnaissance, before this airport was completely closed to air traffic. The above reported coordinates are, indeed, those determined by the ATC control using a related function on the radar screen, just before the aircraft disappeared from the screen itself. All airport operations had already been interrupted at 13.24 UTC, the time the TUI 1153 had confirmed emergency conditions. This issue will be dealt with in detail later on in paragraph 1.15.2.

1.2. INJURIES TO PERSONS

<i>Injuries</i>	<i>Crew</i>	<i>Passengers</i>	<i>Others</i>
fatal	1	15	-
serious	3	13	-
minor	-	7	-

Table 1: Personal injuries suffered.

Three of the four members of the crew (flight captain, co-pilot and flight attendant) suffered serious injuries and were rescued by the rescue services, while the senior flight attendant suffered fatal injuries; as far as the passengers were concerned, 15 suffered fatal injuries and only 12 of these were found by the rescue services on the same day. Three passengers, among which the airline engineer on the flight, were declared missing and their bodies were found on the seabed during the operations for the recovery of the wreckage, described in detail in paragraph 1.15.1.

As far as the definition of serious injuries is concerned, reference has been made to art. 2, paragraph 1, letter b), of legislative decree no. 66¹¹ dated February 25th, 1999.

¹¹ b) "serious injury": an injury which is sustained by a person in an accident and which:

- 1) Requires hospitalization for more than 48 hours, commencing within seven days from the date the injury was received or,
- 2) Results in a fracture of any bone (except simple fractures of fingers, toes or nose); or,
- 3) Involves lacerations which cause severe haemorrhage, nerve, muscle or tendon damage; or,
- 4) Involves injury to any internal organ; or,
- 5) Involves second or third degree burns, or any burns affecting more than 5 percent of the body surface; or,
- 6) Involves verified exposure to infectious substances or injurious radiation.

1.3. DAMAGE TO THE AIRCRAFT

Following impact with the sea surface, the aircraft broke into three main sections:

- LH and RH wings with nacelles and engines and part of the central fuselage;
- The rear, including the vertical and horizontal stabilizers and part of the fuselage;
- Front and central section of the fuselage, also including the cockpit.

The illustration in figure 6 shows the three parts of the aircraft discussed above, with indication of the parts which were recovered later on, as they had sunk shortly after the ditching. Such reconstruction of the wreckage was made immediately after the event, on the basis of the available information, and proved useful for carrying out the subsequent wreckage recovery operations.



Figure 6: Illustration showing the three sections the aircraft broke into, following impact with the sea surface (ANSV reconstruction). The indication “to be recovered” refers to the date of August 6th, 2005. These parts were later recovered.

As far as the front section is concerned (cockpit and the front fuselage), this was completely crushed, as can be seen in photo 2, which relates to the recovery of the wreckage, carried out during the last week of August 2005.



Photo 2: Cockpit soon after recovery from the seabed.

The following paragraph 1.12. includes a more in depth examination of the aircraft wreckage.

1.4. OTHER DAMAGE

No damage to third parties occurred.

1.5. FLIGHT CREW AND ATC PERSONNEL INFORMATION

1.5.1. Flight crew

1.5.1.1. Flight captain (CBD)

Personal details:	Male, Tunisian nationality, age 45.
Aeronautical certifications:	Airline transport pilot licence, issued by the Tunisian Ministry of Transport, valid.
Qualifications:	ATR 42/72 obtained in 1997; B737-200 obtained in 1999.
Medical check:	Valid.
Last Recurrent Training (RT):	June 2 nd , 2005.
Last Crew Resources Management:	October 13 th , 2004.
Last Safety and Rescue Training Course:	January 12 th , 2005.

Last Line Check: April 20th, 2005.
Time of service on previous day: 09h 10'.
Time of rest before the flight: 17h 45'.

He obtained the qualification for multi engine aircraft in 1995 and was given the position of flight captain in the year 2000. From 1979 to 1981 he attended the Tunisian Military Academy with the role of student pilot, obtaining the military pilot licence in 1982. In 1994 he obtained the airline transport pilot licence. He also obtained the helicopter professional pilot licence and the qualification as instructor.

Total flight activity 7182 hours, of which 5582 were on ATR 42/72. He had never previously been involved in aircraft accidents.

1.5.1.2. Co-pilot (OPL)

Personal details: Male, Tunisian nationality, age 28.
Aeronautical certifications: Aircraft professional pilot licence (*Licence Pilote Professionnel avion*), issued by the Tunisian Ministry of transports, valid.
Qualifications: ATR 42/72 obtained in 2002.
Medical check: Valid.
Last Recurrent Training (RT): May 26th, 2005.
Last Crew Resources Management: October 20th, 2004.
Last Safety and Rescue Training Course: January 14th, 2005.
Last Line Check: April 20th, 2005.
Time of service on previous day: 05h 00'.
Time of rest before the flight: 17h 45'.

He obtained the multi engine qualification in 2001 and the licence of commercial pilot with IR and ME qualification in the United States in the year 2000. He was working for the airline involved since 2001. He was qualified to fly on ATR 42/72 aircraft since August 29th, 2002. Total flight activity 2431 hours, of which 2130 were on ATR 42/72 aircraft. He had never previously been involved in aircraft accidents.

1.5.1.3. Flight experience

1.5.1.3.1. Flight captain

Total flying hours:	7182.
Total flying hours on this type of aircraft:	5582.
Flying hours in the last 90 days:	254,15.
Flying hours in the last 30 days:	92,15.
Flying hours in the last week:	14,40.
Flying hours in the last 24 hours:	5,00.

1.5.1.3.2. Co-pilot

Total flying hours:	2431.
Total flying hours on this type of aircraft:	2130.
Flying hours in the last 90 days:	198,15.
Flying hours in the last 30 days:	64,59.
Flying hours in the last week:	16,55.
Flying hours in the last 24 hours:	5,00.

1.5.1.4. Cabin crew

The passenger cabin crew comprised a senior flight attendant (steward - *Chef de Cabine*), assisted by a flight attendant (stewardess) Below is some information of interest.

- *Senior flight attendant*: male, Tunisian nationality, age 38.

He was qualified to carry out the foreseen duties and had a valid licence. He had been employed by the operator in 1991 and was qualified to work on the following types of aircraft: ATR 42/72, B737-200/300 and A320. In addition to the Arabic language, he also spoke fluent French, English and Italian.

In over 13 years of activity, his total hours of flight were 6189. He had become senior flight attendant in 1993.

His hours of flight in the last 90 days, 30 days and week were respectively 97,25, approximately 33 and 4,05.

- *Flight attendant*: female, Tunisian nationality, age 25.

She was qualified to carry out the foreseen duties and had a valid licence. She had been employed by the operator in 2004 and was qualified to work on the following types of air-

craft: ATR 42/72 e A320. The languages spoken, besides the Arabic, were French, English and German. She had worked as a flight attendant for another airline for approximately 14 months. The total hours of flight with the involved Tunisian operator were 368.

Her hours of flight in the last 90 days, 30 days and week were respectively 109, approximately 53 and 15,45.

1.5.2. Air traffic controllers

1.5.2.1. Rome area control centre - ACC

Personal details: Male, Italian nationality, age 54.

Aeronautical certifications and professional qualifications: qualified as aerodrome controller (TWR) since 1975, approach control (APP) since 1977, qualification as Flight Information Centre (FIC) controller 1st class since 1977 and 2nd class since 1978, qualification as “Region” controller since 1986 and as “Radar Region” controller since 1988, the latter obtained at the then Centro Regionale di Assistenza al Volo in Rome.

Medical check: Valid.

Rest period before duty: 14h ca.

Time start duty: 12.55 local time.

English language proficiency: not applicable at the date of event.

Training undergone: that necessary to attain the indicated professional qualifications and titles.

He has always worked as a radar controller at the current radar control centre in Rome.

1.5.2.2. Palermo approach - APP

Personal details: Male, Italian nationality, age 59.

Aeronautical certifications and professional qualifications: aerodrome qualifying licence since 1973, for procedural approach since 1987 and approach radar since 1993.

Medical check: Valid.

Rest period before duty: 48h.

Time start duty: 15.00 local time.

English language proficiency: not applicable at the date of event.

Training undergone: three theoretical-practical traineeships to obtain the qualification as aerodrome controller (duration approximately 12 months), the qualification as procedural approach controller (duration approximately 4 months) and the approach radar qualification (duration two months).

He has always worked as an air traffic controller at Palermo's Punta Raisi airport and, in an operational support capacity, at Pantelleria airport.

1.5.3. Passengers

All passengers on the aircraft (35), with the exception of the operator's airline engineer, whose ground duty was to assist the flight crew in the preparation of the aircraft, were of Italian nationality. Figure 7, with the aircraft floor plan, shows the positions of the passengers before ditching. The positions of the flight crew, the two flight attendants and the engineer, whose intervention inside the cockpit was requested by the flight captain, are also shown.

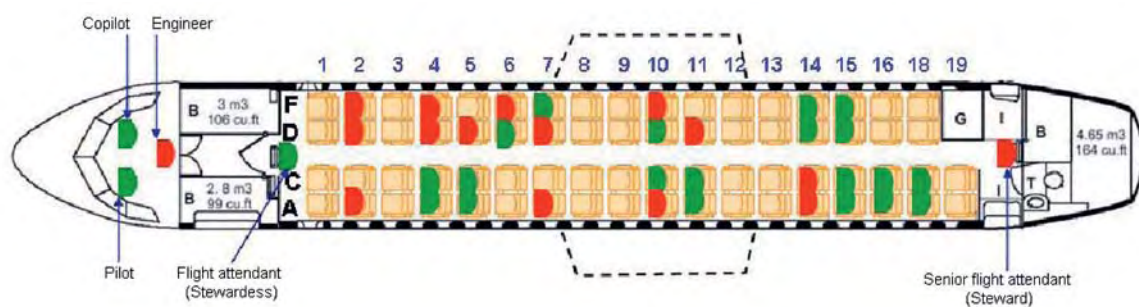

Figure 7: ATR 72, TS-LBB seat occupation on the aircraft before ditching.

With reference to Figure 7, the red boxes indicate the occupants who suffered fatal injuries, while the green boxes indicate the position of the survivors on the aircraft. The following paragraph 1.15.3. provides a description of the type of injuries suffered by the passengers, linking their position on the aircraft to the deformations which occurred to the aircraft following ditching.

1.5.3.1. Passengers' evidence

The evidence given by the passengers revolved mainly around their actions and the instructions received by the flight attendants during the whole duration of the flight.

All evidence was consistent in describing the actions of the flight attendants from the beginning of the emergency situation to the final moments, before and after the impact of the aircraft on the sea surface. Below are some points, which are considered of importance.

- Before leaving Bari, the safety briefing was given in Italian.
- The senior flight attendant was able to speak and understand Italian, however the other flight attendant (stewardess) knew only a few words.

- During the final emergency stage, and specifically from the moment the passengers were informed of an unexpected stop in Palermo, the flight attendant (stewardess) became clearly agitated. Some passengers asked her a few times, without any answer, the reasons for her behaviour.
- Some passengers indicated that they saw a passenger entering the cockpit (this was the engineer called by the flight captain). This caused them further worry.
- Some passengers indicated that they only wore the life jacket after seeing the flight attendant (stewardess) doing the same.
- Some passengers inflated their life jackets before ditching, against the precise instruction given by the senior flight attendant using a portable megaphone¹², stating that they should only be inflated after the ditching and immediately before leaving the aircraft.
- Many passengers, particularly those who had inflated the life jacket inside the aircraft, said they lost it following impact with the sea surface.
- Almost all passengers remember that they found themselves outside the aircraft after the impact, or that they immediately exited the aircraft from the openings in the fuselage caused by the impact.
- At the moment of ditching, all passengers were sitting with their seatbelts on.
- The passengers sitting from row 14 onwards remember an impact characterised by a loud boom, after which they found themselves immediately submerged by the water and resurfaced through a break between the central part of the cabin and the tail.
- None of the passengers indicated they could smell fuel after the ditching, once they were in the water.

1.5.4. The Operator's maintenance personnel involved in the event

1.5.4.1. Team leader

Male, 43 years old, Tunisian nationality. Valid A category aircraft avionics maintenance licence. After obtaining a diploma in electrotechnic, from 1980 to 1982 he attended the *École Aéronautique Civile et de Météorologie* (EACM), obtaining the diploma of aircraft technician specialised in aircraft equipment.

In 1983 he started working for the operator involved in the event.

He attended several training courses on B737, B727, A320 and ATR 42/72 aircraft equipment (maintenance course, electrical systems and avionic equipment, EGPWS SPZ-6600).

¹² The only system that can be used which is compatible with the type of emergency occurring.

On August 5th, 2005, he was due to complete a normal airport shift as team leader, with working hours from 07.00 to 15.00 local time. Arriving at work as usual, he then flew on aircraft TS-LBB, routes Tunis-Catania and Catania-Tunis, fulfilling the role of flight engineer, replacing a colleague who was late. Upon his return to Tunis, at 11.00 UTC, he went to search the system for a working FQI, so that the one currently on the TS-LBB could be replaced, once the aircraft returned from its flight late that afternoon. He carried out the search using a video terminal (VDU - Visual Display Unit) search and filled out the form for the collection of the part from the store, because only the team leader is authorised to sign such a document. He then left work a few minutes earlier than the end of his shift. August 6th, 2005, was his day off. During the previous days he had worked normally, without exceeding standard working hours.

1.5.4.2. Maintenance engineer who replaced the FQI on the TS-LBB

Male, 33 years old, Tunisian nationality. Valid A category aircraft avionics maintenance licence. He attended the Tunisian *École Militaire*, leaving the Armed Forces in 1997.

He started working for the operator of the TS-LBB in the year 2000, with whom, during the same year he attended a MAS (acronym of *Moteur, Système*) training course, on ATR 42/72 aircraft.

On August 5th, 2005, he worked the afternoon shift. During the previous days he had worked normally, without exceeding standard working hours.

1.5.4.3. Maintenance technician (engineer) on board the aircraft

Male, 40 years old, Tunisian nationality. Valid category A aircraft avionics maintenance licence. He was employed by the operator involved in the event since 1997, and attended a MAS training course on ATR 42/72 aircraft.

During the flight to Bari he did not carry out any maintenance interventions; he only assisted the refuelling operator during refuelling before departure.

He was on the ferry flight from Tunis to Bari (flight UG 152F) because the airline procedures called for an engineer to be on the flight for carrying out ground maintenance operations, should no technical personnel of the airline be stationed at the airport, which was the case for Bari Airport. When assessing the number of people on the flight, he is counted as a passenger. During the aircraft refuelling operations, both in Tunis and Bari, he assisted the refuelling operator, signed the fuel slip and handed the copy over to the flight captain.

1.6. AIRCRAFT INFORMATION

1.6.1. Aircraft technical-operational data

Type of aircraft:	ATR 72.
Model:	ATR 72-202.
Manufacturing number:	258.
Year of manufacture:	1992.
Service entry date:	March 25 th , 1992.
Registration marks:	TS-LBB.
Certificate of airworthiness:	valid until December 27 th , 2005.
Date of last major inspection (C type):	March 6 th , 2004.
Hours of flight after the last C type inspection:	2572.
Cycles completed after the last C type inspection:	3269.
Date of last minor inspection (A type):	May 25 th , 2005.
Hours of flight after the last A type inspection:	413,5.
Cycles completed after the last A type inspection:	512.
Owner:	Tuninter - 10 Rue de l'Artisanat - Z.I. La Charguia II 2035 Tunis – Carthage.
Operator:	Tuninter.

1.6.2. General TS-LBB technical data

Configuration:	70 seats.
Minimum number of flight crew:	2 (flight captain and co-pilot).
Maximum takeoff mass (MTOM):	21.500 kg.
Mass without fuel (Zero fuel mass):	16.700 kg approximately.
Fuel inside the plane before leaving Bari:	570 kg approximately.
Actual mass during Bari takeoff:	17.250 kg approximately.
“Fictitious” mass during Bari takeoff:	19.400 kg approximately.

Note: for the purpose of simplicity, during the course of the report the mass indicated as “fictitious” is the mass of the aircraft estimated by the crew, on the basis of the indication of fuel on the aircraft as being 2700 kg. In actual terms, the quantity of fuel in the aircraft after refuelling at Bari was approximately 570 kg.

Wing span:	27,05 m.
Length:	27,17 m.
Height:	7,65 m.

Total aircraft operating hours: 29.893,50.

Total cycles: 35.259.

The position of the centre of gravity was within acceptable limits. The passenger cabin had a configuration with 17 rows with 4 seats each, and the last row, no. 19, with two seats on the left-hand of the corridor. The seats allocated to the flight attendants, for takeoff, landing and emergency situations, were one at the back and the other at the front of the aircraft. In this particular case, the flight attendant (stewardess) was positioned in the front jump-seat with her back facing the cockpit, and the senior flight attendant was on the seat at the back of the aircraft, with his back facing the tail of the aircraft.

A jump-seat was also in the cockpit, normally used by authorised personnel.

1.6.3. Power plant information

The ATR 72 aircraft is fitted with two Pratt & Whitney Canada (PWC) turbine engines, model PW124B. Each one of the engines uses a reduction box to drive a model 14SF-11 Hamilton Sundstrand (HS) four-blade propeller.

The engine is made of three rotating assemblies:

- Low pressure compressor (LPC), connected to the low pressure turbine (LPT) with a shaft.
- High pressure compressor (HPC), connected to the high pressure turbine (HPT) with a shaft which is coaxial to the previous one;
- Two-stage power turbine, connected to the propeller through the reduction box.

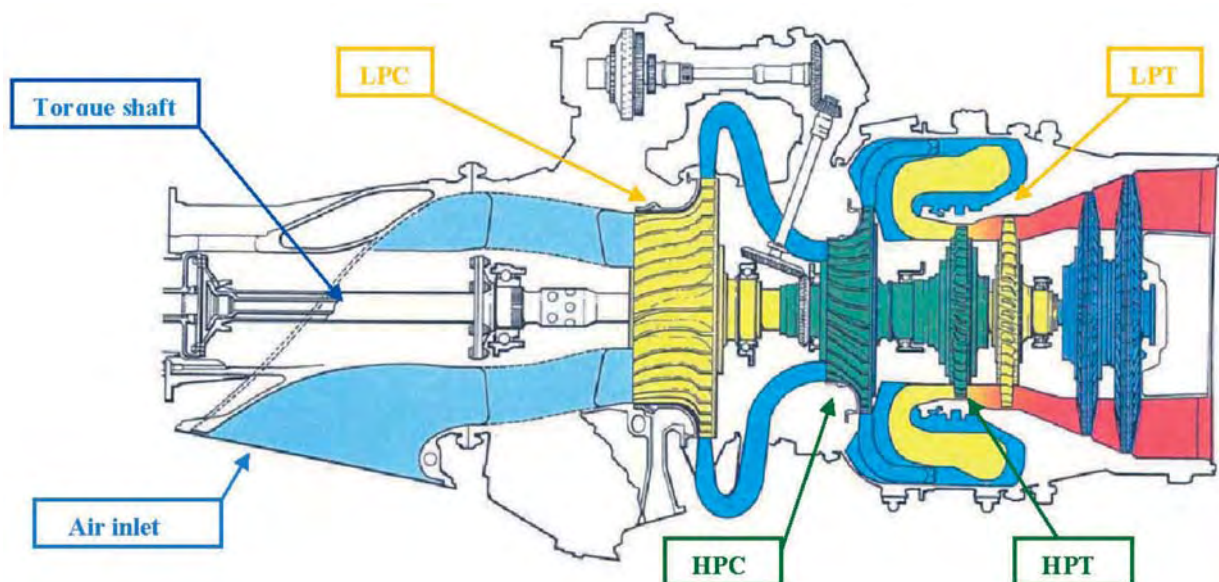

Figure 8: PW100 series engine structural drawing.

The three coaxial shafts are independent from each other and rotate in opposite directions and at different speeds.

The air, sucked from the atmosphere through the air inlet, passes through the compressors and enters the combustion chambers. The hot gases generated by fuel combustion passes through the low and high pressure turbines, which turn part of the gas energy into mechanical energy for driving the compressors. The two power turbines then transform the gas residual energy into mechanical energy, which powers the propeller.

This type of engine design is called free turbine design and is characterised by the fact that the speed of the propeller (measured by the NP parameter) is independent from the speed of the gas compressor-turbine generator assembly (the rotating speed of the low and high pressure compressors are measured using the NL and NH parameters respectively).

The speeds of the three shafts are expressed, for simplification purposes, as percentages of a pre-determined value (100% NL = 28.800 rpm, 100% NH = 34.200 rpm and 100% NP = 20.000 rpm; with a reduction gearbox ratio of 16,67:1, a propeller speed of 1.200 rpm is achieved).

Starting of the engine

The engine is started by activating the electric starter which, mounted on the gear box, orders the rotation of the high pressure turbine and compressor; when the number of NH revolutions reaches a high enough level (equal to 30%), feeding of the fuel into the combustion chamber starts. Setting ENG START to the relevant position, will power two small igniters that trigger fuel combustion. Further details on the engine starting procedure are outlined in the following paragraph 1.18.4.2.

Relevant features and controls

The normal takeoff power is 2150 hp, with the possibility of delivering a maximum power of 2400 hp in standard condition, should a failure occur on one of the engines. The propeller pitch is adjusted by a control unit (*Propeller Control Unit*). This can change the pitch from -10° (reverse thrust) to 86.5° (full feather, position of minimum drag to forward motion).

The power controls are located on the centre pedestal, on which it is possible to distinguish:

- Power Levers (PL) which control the power delivered by the engines (FDR's PLA parameter)
- Condition Levers (CL) which control the propeller's revolutions (FDR's NP parameter) and the position of the engine high pressure fuel delivery valve (Fuel Shut Off).

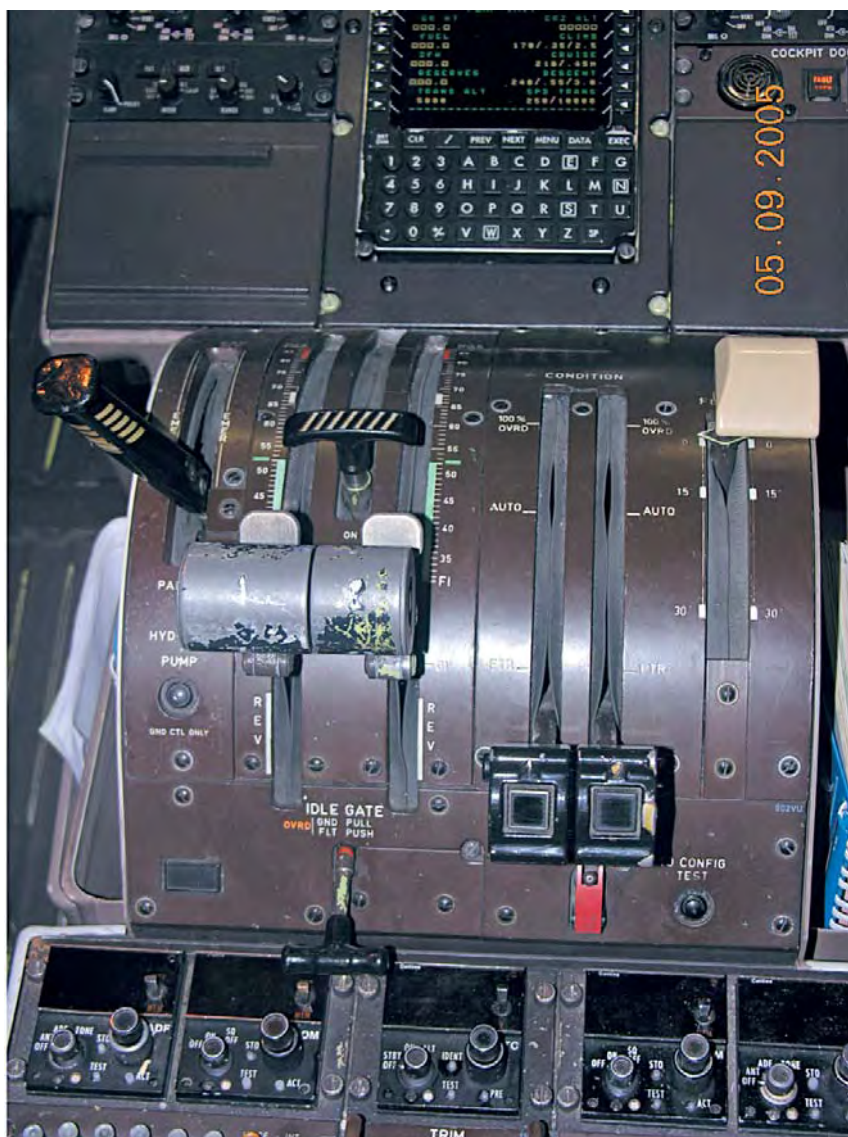

Photo 3: Controls for the adjustment of engine power (PL on the left) and propeller revolutions (CL on the right).

During the various stages of the flight, the two controls are however, strictly connected. In particular, with the propeller turning at a constant number of revolutions, moving the PL will change the propeller pitch, and at constant power, moving the CL will change the propeller pitch and therefore also the number of revolutions.

When on the ground, the propeller can be blocked with a hydraulic brake, using the engine to provide electric power and air conditioning to the cabin (*Hotel Mode*).

1.6.4. Engines and propellers installed on the TS-LBB

The two tables that follow list the significant data of the engines and the propellers installed on the TS-LBB aircraft at the time of the accident. The hours of operation for the last five flights

completed before taking off from Bari are an estimate and the actual data could differ by a few tens of minutes.

Position:	#1 (Left or LH)	#2 (Right or RH)
Manufacturer and model:	PWC – PW 124B	PWC – PW 124B
S/N:	124638	124557
Date of construction:	March 1993	March 1992
Total hours and cycles:	18.159h – 21.435	21.513h - 25.510
Last servicing:	July 21 st , 2004, at 16.766h	December 9 th , 2003, at 19.260h
Hours and cycles after last servicing:	1393h – 1768	2253h – 2863
Installed on TS-LBB on:	March 29 th , 2005, at 17.421h	May 4 th , 2004, at 19.260h
Hours and cycles after installation:	738h – 942	2253h – 2863

Table 2: data of the engines installed on the TS-LBB aircraft.

Position:	#1 (Left or LH)	#2 (Right or RH)
Manufacturer and model:	HS - 14SF-11	HS - 14SF-11
S/N:	911028	910107
Date of construction:	November 5 th , 1991	January 29 th , 1991
Total hours and cycles:	23.419h – 27.341	20.626h – 24.420 cycles
Last servicing:	January 19 th , 2001, at 17.547h	August 16 th , 2002, at 17.655h
Hours and cycles after last servicing:	5872h – 7084	2971h - 3796
Installed on TS-LBB on:	May 11 th , 2005, at 22.941h	November 19 th , 2003, at 17.655h
Hours and cycles after installation:	478h - n.a.	2971h - 3796

Table 3: data for the propellers installed on the TS-LLB aircraft.

Left-hand engine S/N 124638

Following the last servicing operation, carried out at an approved maintenance company, on September 19th, 2004, the engine was installed on the TS-LBC aircraft, in the right position.

On January 12, 2005, after only 655 hours of service, it became necessary to remove the engine and send it for repair due to an FOD (Foreign Object Damage). After the repair, on March 29th, 2005, the engine was installed on the TS-LBB aircraft, in the left position. The examination of the logbook, did not reveal any significant inefficiencies that could be connected with the event, which may have occurred during the days immediately before the event.

Right-hand engine S/N 124557

Following the last servicing operation, carried out at an approved maintenance company, on May 4th, 2004, the engine was installed on the TS-LBB aircraft, in the right position. All inspections, to be carried out in accordance with the approved maintenance program, have been regularly recorded. The examination of the aircraft's logbook for the days immediately before the event did not reveal any significant inefficiencies of the engines that could be connected in any way to the event.

Left-hand S/N 911028 and right-hand S/N 910107 propellers

The examination of the available technical documentation has shown that all expected maintenance inspections have been regularly carried out, within the due dates, by approved maintenance organization. No significant issues, which could be linked to the accident, emerged from the examination of the aircraft's logbook for the days immediately before the event.

1.6.5. ATR 72 fuel system

Attachment "E" gives a complete description of the fuel system of the ATR 72, as found in the FCOM (Flight Crew Operation Manual). Below are some of the main characteristics of the system.

1.6.5.1. Description and main characteristics

The main components of the fuel system are:

- Two wing fuel tanks (each of them supplying the corresponding engine), each fitted with an electric pump and a jet pump;
- The ventilation system;
- The fuel indicator system;
- The refuel/defuel system with the associated control and indication accessories.

The wing fuel tanks are an essential part of the wing structure. They have a capacity of 3185 litres (2500 kg with a fuel density equal to 785 kg/m³) each. Table 4 summarizes the above description.

	Per tank	Total
Volume	3185 litres (840 US gal)	6370 litres (1680 US gal)
Mass	2500 kg (5512 lbs)	5000 kg (11.025 lbs)

Table 4: volume and mass fuel capacity of the wing fuel tanks.

Each tank is fitted with a gravity refuelling point. This is located at the top of the relevant wing (*overwing refueling cap*). In the Wing Centre Box are all fuel pipes for single point refuelling and for the crossfeed of the two tanks.

During normal conditions, each engine is fed by the corresponding tank through a feeder. The feeder is always kept full, to ensure that the fuel supply is not interrupted during abnormal conditions, such as negative accelerations and unusual attitudes. Upon starting the engines, fuel supply is ensured by an electric pump. After the engines have been started the jet pump provides the fuel supply to the engines. If the supply pressure falls below 5 psi (equal to approximately 350 mbar), the electric pump will automatically activate to ensure correct supply.

Each wing also contains two magnetic level indicators (dripstick – photo 4), for on ground assessment of the quantity of fuel inside the tank by means of a graduated rod and a conversion table, which takes into consideration the density of the fuel and the aircraft attitude.



Photo 4: Graduated rod (*dripstick*) for checking the quantity of fuel in the wing fuel tanks.

1.6.5.2. The fuel indicator system

The system provides the flight crew with the information of the quantity of fuel inside the wing fuel tanks, in kg or in pounds, depending on the aircraft model. The information is displayed on the Fuel Quantity Indicator (FQI) inside the aircraft, in the upper center instrument panel 4VU.



Photo 5: ATR 72 - Center instrument panel – (FQI is indicated by the arrow).



Photo 6: Fuel Quantity Indicator.

The same indication is also repeated on the centralized refuelling panel on the right-hand of the aircraft (see photo 10).

The quantity of fuel is measured by six capacitive probes, which are installed on each wing fuel tank. They are mounted on the upper surface of the tank, and can be removed from the outside without emptying the corresponding tank. Any variations in the quantity of fuel inside the tank causes a variation of the wet portion of the probe, and therefore of the capacitance. Such capacitance value is sent to the FQI, which, depending on the calibration (different on ATR 42 and ATR 72 models), processes the signal and displays the quantity of fuel in each tank, either in kg or in pounds. In simple terms, the FQI is an instrument processing the signal from the capacitive sensors installed inside the wing fuel tanks, based on an algorithm, which is specific to each type of aircraft, depending on the shape of the tanks, their sizes and the number of probes.

The ATR 42 and ATR 72 type FQIs are identical in their dimension and installation procedure. Therefore an ATR 42 type FQI could be installed by mistake on an ATR 72 aircraft and vice versa. The only difference between the two FQIs, when installed on the aircraft, is white lettering indicating the maximum fuel quantity for each wing fuel tank. This can be found on the front of the instrument and is “2500” for the ATR 72 type FQI and “2250” for the ATR 42 type.



Photo 7: FQI ATR 42.



Photo 8: FQI ATR 72.

Difference between FQIs, when not installed on the aircraft, is also determined the P/N on data plate on top of it which is different between ATR 72 and ATR 42 type FQIs .

Low level indications (LO LVL)

Two LEDs with the indication “LO LVL” can be found on the front panel of the FQI. These LEDs warn the crew when the level of fuel inside the right and left tanks is low. The illumination of the LED, amber in colour, is accompanied by a single acoustic beep (*single chime*) and by the illumination of the Master Caution (MC). In case of low fuel level, below to 160 kg x 2:

- The amber LED on the FQI comes on;
- The amber “*fuel*” LED on the CAP (*Centralized Alarm Panel*) illuminates.
- Master Caution + acoustic warning activate.

In line with the system logic, the coming on of the LO LVL LED occurs when the fuel quantity is lower than 160 kg on the associated wing tank. This information is provided by the FQI instrument itself, which calculates the quantity of fuel present on the basis of the signals coming from the capacitive sensors installed inside the wing fuel tanks.

The fuel system of the TS-LBB aircraft (type ATR 72-202) was fitted with a low fuel level warning system totally depending on the indication system because the activation of low level warnings was ordered by the FQI instrument. In other words, the low level signal is dependent on the quantity processed by the FQI on the basis of the signals coming from the capacitive sensors of the wing fuel tanks.

The current certification specifications - “EASA *Certification Specification 25 - Large Aeroplanes*” (which replaces the previous JAR-25), applicable to ATR 42 and ATR 72 type aircraft -, does not specifically require that the fuel system is fitted with a low level warning system independent from the fuel quantity indicator system.

Attachment “C” includes copies of the documentation concerning the construction and installation details of the FQI.

1.6.5.3. Centralized refuelling mode

The aircraft can be pressure refuelled by using only one centralized refuelling point (see photo 9) located on the lower fairing of the right-hand landing gear. As explained below in detail, refuelling can be either automatic or manual. It is also possible to separately refuel the two wing fuel tanks by gravity, using the two filler caps.

The pipe for the centralized refuelling point is connected to the valves of each tank (right and

left). They are controlled by their respective FQI (the FQI is divided in two sections, each indicating the quantity of fuel present in the relevant tank), so that the total fuel quantity can be balanced between the two.



Photo 9: Centralized refuelling point.

Automatic mode (standard)

In the automatic mode the procedure call for selecting the desired quantity with the selector at the bottom left of the panel (photo 10). The selected quantity is the total fuel mass to be inside the tank and not the quantity of fuel to add.

Move then the fuel selector to the “REFUEL” position to start refuelling.

Two indicators at the bottom right of the panel repeat the indications of the fuel quantity actually inside the aircraft, as appearing on the FQI inside the cockpit.

At the end of the procedure, the two wing fuel tanks will contain the same amount of fuel.

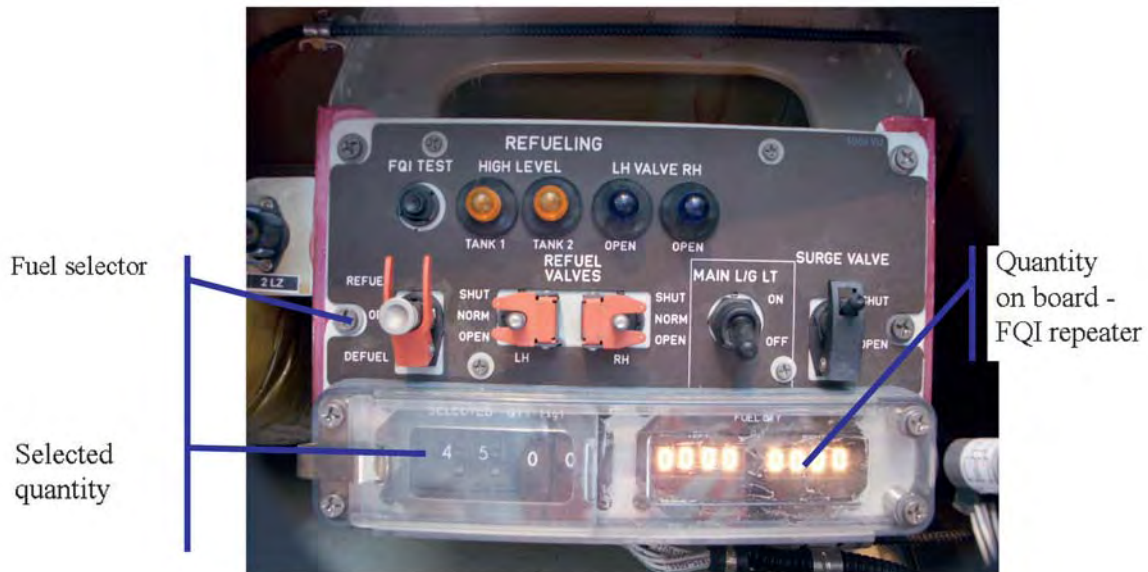

Photo 10: External centralized refuelling panel.

Automatic refuelling is therefore completed by pre-selecting the mass of fuel requested as Block Fuel (the quantity of fuel before starting the engine) on the external refuelling panel. When the FQI shows that the selected quantity has been reached, the valves close and the fuel flow is interrupted.

Manual mode

In the manual mode either valve can be forced open or forced closed to allow the tanker to refuel each tank separately.

The quantity of fuel must be monitored using the FQI digital indicator on the centralized refuelling panel (photo 10).

1.6.5.4. Fuel consumption indicator

In addition to the FQI, the flight crew can also check and determine the quantity of fuel used during the flight using the integrated instrument *Fuel Flow/Fuel Used* (FF/FU indicator, at the bottom right of photo 11). The aircraft is fitted with a separate FF/FU indicator for each engine. The consumed fuel quantity value is digitally displayed on the display. This is obtained by integrating the values of the fuel flow parameter of the related engine. Since the fuel flow indicators allow throughout the flight the computation of fuel consumed directly from the engine, the FF/FU value is totally independently from the FQI indication.



Photo 11: Section of the instrument panel.
The Fuel Flow (FF) and Fuel Used (FU) can be seen on the bottom right.

1.6.6. Electrical system

Two direct current (DC) generators, directly driven by the respective engines, provide the 28 V power supply to the electrical equipment inside the aircraft. Alternating current (AC at 115 V and 400 Hz) is provided by two statue inverters and for any equipment not requiring a stable frequency, by two AC generators driven by the propellers.

Distribution is through a bus bar system, to which the various devices are connected.

In case of electrical failure of the two generators, as in case of engine shutdown, the electrical supply is ensured, for the essential users only, by two batteries (main battery at 43 Ah and the emergency battery at 15 Ah).

The main battery is used for powering a series of devices, including the engine start and the propeller's pitch. Should a double engine failure occur, it would therefore be possible to restart the engines and fully feather the propeller to minimise drag to forward motion.

Should the main battery, become exhausted, for example following repeated attempts to restart the engines, the emergency battery will provide power to primary equipment.

The QRH, on page 2.17, shows a summary table of the available users depending on the type of failure occurring to the electrical system, with reference to the availability of the various electrical distribution bus bars (Attachment "B").

1.6.7. Centralized warning system

The acoustic and visual warning system (Centralized Crew Alerting System, CCAS) sends warning signals to the flight crew in case of malfunction or abnormal configuration of the aircraft, also indicating, when applicable, any corrective action.

Visual warnings

- Master Warning (MW) and Master Caution (MC): these are flashing warnings informing the flight crew that a failure has occurred to one of the aircraft's systems. Depending on the seriousness of the failure, either the MW or the MC will flash (with the MC having a lower critical level than the MW).
- Crew Alerting Panel (CAP): this is a light panel aimed at immediately providing the crew with indication of the system experiencing malfunction or the abnormal aircraft configuration.

In addition, LEDs placed by the control panels of the aircraft's systems give indications on the faulty system and on the corrective actions for their recovery (*local alert*).

Acoustic warnings

- Continuous Repetitive Chime (CRC), associated with the illumination of the Master Warning and a red light on the Crew Alerting Panel.
- Single Chime (SC), associated with the activation of the MC and an amber light on the CAP. For example, the illumination of the "FEED LO PR" LED on the fuel system indication panel will trigger a single acoustic warning (SC), the MC and FUEL light on the CAP will also activate.

During particular flight conditions and/or aircraft system operations, there are other types of acoustic warning, particularly when a stall is imminent (*cricket*, an intermittent sound), and when the autopilot becomes disconnected (*calvary charge*) etc.

Warning levels

Warnings can be classed according to 4 levels, briefly described below.

- Level 3 (*Warnings*): it indicates an emergency situation requiring the immediate intervention of the crew. In this case both the MW and the relevant red light on the CAP will illuminate together with an acoustic warning (CRC).

- Level 2 (*Cautions*): indicates an abnormal condition not requiring the immediate intervention of the crew. In this case both the MC and the relevant amber light on the CAP will illuminate together with a single acoustic warning (SC).
- Level 1 (*Advisories*): indicates a situation only requiring careful monitoring by the crew. This condition is identified by the illumination of an amber light, without any acoustic warnings.
- Level 0 (*Information*): indicates a change of state of the system or, in any case, an abnormal condition. This type of indication is associated with the illumination of the white, blue and green lights.

1.7. METEOROLOGICAL INFORMATION

The METAR bulletins regarding Palermo's Punta Raisi airport for the times of 13.20 and 13.50 UTC on August 6th, 2005, contained the following information:

- 13.20: wind from 330°, 7 knots, visibility over 10 km, little cloud (FEW) at 2500 ft, temperature 29 °C, dew point 16 °C, QNH 1013 hPa;
- 13.50: wind from 320°, 8 knots, visibility over 10 km, little cloud (FEW) at 2500 ft, temperature 28°C, dew point 16°C, QNH 1013 hPa.

According to the documentation supplied by the Port Authority of Palermo (Capitaneria di Porto), the sea conditions at the moment of ditching off the coast of Palermo were characterised by a moderate breeze from northwest (NW), force 4, state of the sea NW 3 to 4 (Douglas scale index), with the direction of the waves being southeast. Visibility was good and the sky was clear.

According to the Douglas scale, sea surface conditions corresponded to a slight (index 3) to moderate (index 4) sea, with average wave height between 0.50 and 1.25 metres (index 3) and 1.25 to 2.50 m (index 4). According to the Beaufort scale, the wind conditions corresponded to moderate, with an average speed of 11 to 16 knots. Its effect on offshore waters is of small waves that have a tendency to become long, with a probable maximum height of 1,5 m and an average height of 1,0 m¹³.

In order to assess any influence of the wind, at an altitude starting from flight level 230 from the ground, the Italian Air Force was requested to provide the significant meteorological information for the period between 12.00 and 15.00 UTC of the day the event took place, for the area

¹³ The probable height of the waves indicates conditions which are typical of the open sea at a significant distance from the coast.

included between the geographical coordinates listed below:

A: 40° 00' 00" N 12° 00' 00" E.

B: 40° 00' 00" N 14° 00' 00" E.

C: 38° 00' 00" N 14° 00' 00" E.

D: 38° 00' 00" N 12° 00' 00" E.

In particular, the following meteorological documentation has been supplied for August 6th, 2005:

- SIGMET and AIRMET messages;
- volcanic ash warnings;
- ground level analysis, 850 hPa and 500 hPa of 12.00 hours UTC;
- IR and VIS satellite images from 12:00 to 15:00 hours UTC;
- wind analysis at 1000 hPa, 925 hPa, 850 hPa, 700 hPa, 500 hPa and 400 hPa, of 12.00 UTC, for the above specified area.

The wind condition values can be referred to the quadrant relating to the zone where the aircraft experienced the engines failures; the time of reference is however 12.00 hours UTC, approximately 90 minutes before the event. The data for 13.00 and 14.00 hours UTC are not available. The analysis documentation has in fact been taken from the archives of the European centre, where they are produced on European rather than on Italian scale and at 6 hourly intervals (e.g. 12.00 and 18.00 UTC).

From the analysis of the above documents it has been assumed that the meteorological conditions along the course followed by the aircraft from taking off from Bari to the point of ditching were characterised by a cloudless sky with visibility of over 10 km. In addition, there were no warnings of volcanic ash for the zones crossed by the aircraft.

1.8. AIDS TO NAVIGATION

There were no failures to the ground navigation systems and radar support did not highlight any kind of problems. Figure 9 shows in blue the route followed by the aircraft, with the planned route from the flight plan being shown in red (only the section of interest up to the east coast of Tunisia is highlighted).



Figure 9: Chart showing the planned route from the flight plan (red line) and the route actually followed by TS-LBB (blue line).

Based on existing traffic conditions, air traffic control had authorised TUI 1153 to directly proceed to the compulsory reporting points (waypoints) of LUNAR, AMANO and TUPAL (this last one between Sicily and the east coast of Tunisia), without flying over Sorrento, Palermo and Trapani radio beacon as originally indicated in the flight plan.

There was no implementation of any NOTAM concerning failures/inefficiencies of the radio beacons along the route or any other ground support services.



Figure 10: Chart showing the route of the TS-LBB as obtained from FDR data

1.9. COMMUNICATIONS

No technical problems were recorded during the radio communications between the aircraft and the air traffic control units involved in the event. This was also the case after both engines had failed, when TUI 1153 only had one VHF/COM device available, powered by the emergency battery.

During communication with Rome area control centre (Rome ACC), TUI 1153 declared the emergency condition (MAYDAY) twice. Having already expressed their intention to divert to Palermo airport, the crew was then instructed to contact Palermo approach control (Palermo APP). While issuing the second emergency declaration, TUI 1153 stated that both engines had failed (“*we lose both engines*”) and requested radar guidance to help them to reach Palermo. As a consequence, the controller at Rome ACC asked them to change frequency and contact Palermo APP directly for landing instructions. He had not understood, during the radio communication with the aircraft, that both engines had in fact failed, and considering that he would not have been able to assist TUI 1153 up to the completion of the landing procedure in Palermo, because of the characteristics of the area radar, he decided that the best solution would be to transfer TUI 1153 to Palermo APP for the continuation of the flight.

The ATC general operating procedures applicable when handling emergency situations can be found in chapter 15 of the Doc 4444 ATM/501 (Air Traffic Management) of ICAO. The same document also indicates that emergency situations are normally characterised by a series of

circumstances and conditions that will vary depending on the actual type of emergency. This makes it therefore difficult to established detailed operating procedures to follow. Nevertheless, the procedure which should normally be followed is to ask the aircraft declaring the emergency situation what kind of failure is being experienced, so that any needed rescue activities can be coordinated. The above mentioned Doc 4444 also states that any changes in frequency should, if possible, only take place if a better service to the aircraft involved can be ensured.

1.10. AERODROME INFORMATION

The aircraft had left Bari with destination Djerba, Tunisia. Palermo airport was the closest to the aircraft at the time the failure to the two engines occurred and the crew asked, and was granted, authorization for an emergency landing.

The aircraft had established radio contact with Palermo Approach Control. This had been maintained at all times.

Palermo airport (ICAO code LICJ) is positioned on the geographical coordinates 38° 10' 55" North and 13° 05' 58" East, at an altitude above sea level of 19 metres. The airport has two runways, the 02/20 (length 2074 metres, width 45 metres) and the 07/25 (length 3326 metres, width 60 metres). The following table is a summary of its characteristics of main interest.

ICAO Code	LICJ.
IATA Code	PMO.
Altitude from sea level:	19 m.
Position:	35 kilometres from Palermo.
Geographical coordinates:	38° 10' 55" North. 13° 05' 58" East.
Orientation of runways (QFU)	02/20. 07/25.
Lighting systems:	02: high intensity runway edge lights, high intensity approach lighting system, optical path indicator system (slope 3,0°); 20: high intensity runway edge lights, runway identification lights, high intensity approach lighting system, optical path indicator system (slope 3,0°), runway visual range; 07: high intensity runway edge lights, high intensity approach lighting system, optical path indicator (slope 3,0°); 25: high intensity runway edge lights, high intensity approach lighting system, optical path indicator (slope 3,0°).
Navigation aids:	instrument landing system, precision approach radar, 1 st category distance measuring equipment (20 and 25 runway thresholds), omnidirectional radio range (TVOR "PRS"), precision approach radar, distance measuring equipment (DME), directional localizer or radiobeacon, direction finder.
Radio frequencies:	Approach (APP): 120.2 and 118.65 MHz; Control tower (TWR): 119.05 MHz.

Table 5: Characteristics of main interest of Palermo's Punta Raisi airport.

As soon as the aircraft confirmed the emergency condition and the possible need to land in Palermo, the airport was closed to traffic. This was done to enable the rescue services to position themselves at the sides of the runway to be used for any possible landing. Only a commercial flight, using a B737 (as detailed in the following paragraph 1.15.2.) was allowed to take off at approximately 14.00 UTC (20 minutes after ditching), with the aim of precisely locating the wreckage and thus facilitating the rescue operations. In particular, the B737 flight captain informed Palermo TWR of sighting the wreckage in a location, as referred to the TVOR/DME “PRS”, on radial 053°, distance 22 NM. The TVOR/DME “PRS” radio navigation aid is at Palermo airport premises.

1.11. FLIGHT RECORDERS

1.11.1. Description of the recorders

When the accident occurred the following flight recorders (FDR and CVR) and Flight Data Acquisition Unit (FDAU) were installed on the aircraft:

Recorder/FDAU	Manufacturer and Model	P/N	S/N
Cockpit Voice Recorder	Fairchild (now L3-Com) A100A	93-A100-83	62067
Flight Data Recorder	Fairchild (now L3-COM) F800	17M800-261	4612
Flight Data Acquisition Unit	SFIM	360A45182A13	539

Table 6: Flight recorders and data acquisition unit.

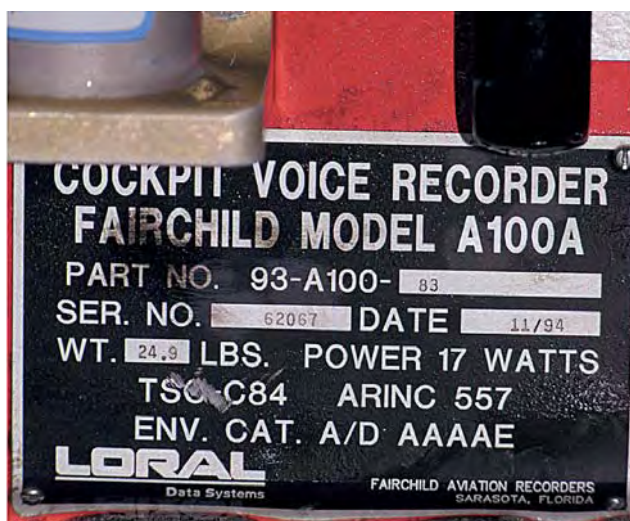

Photo 12: CVR identification plate.



Photo 13: FDR identification plate.

The CVR Fairchild A100A installed at the back of the fuselage on the left-hand, uses a 1/4" 308 ft long magnetic tape ensuring recording time of 30 minutes. The tape unwinds and rewinds on a single reel. The recorded tape winds on the outside of the reel, while the less recent part is extracted from the inside, cancelled and re-recorded (see photos 14 and 15).

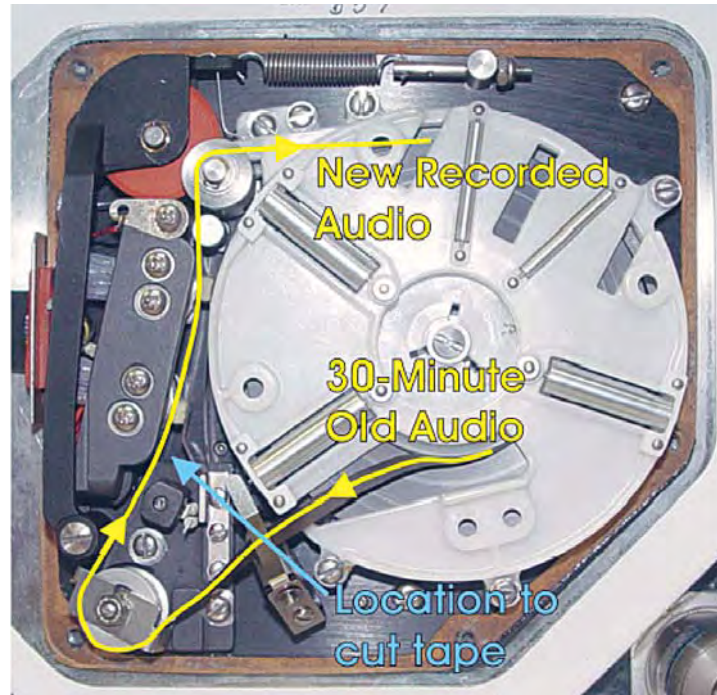

Photo 14: A100A model CVR, tape and heads.

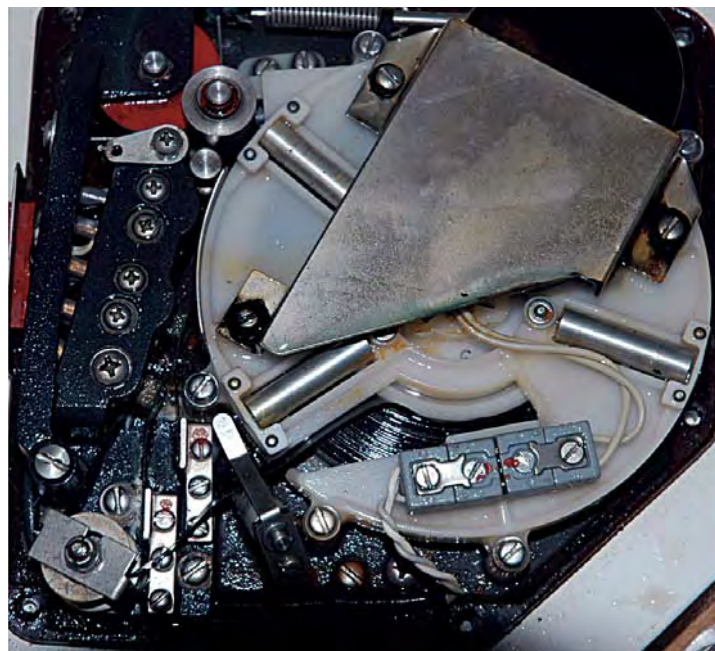

Photo 15: TS-LBB CVR (internal components).

The CVR simultaneously records 4 audio tracks. These correspond to the signals coming from the following channels:

- Communications to passengers / third officer (called *Spare*);
- *Hot Mic* of the co-pilot (called *Co-pilot*);
- *Hot Mic* of the flight captain (called *Pilot*);
- Cockpit area microphone (called CAM).

On the front of the CVR, as well as the FDR, is a battery powered device called Underwater Locator Beacon (ULB). The immersion of the ULB causes the closing of a water sensitive switch that will activate a pulsating sound signal (37,5 KHz, 100 ms) for approximately 30 days, to facilitate underwater search and recovery.

Also the Fairchild F800 FDR uses a 1/4" magnetic tape, which also unwinds and rewinds on a single reel, as a support for the recording of flight information (flight path, speed, attitude, power delivered by the engines, configuration etc.). Data acquired by the FDAU, suitably formatted, is recorded in sequence on six tracks, arranged in parallel along the length of the tape. In the specific case of the TS-LBB aircraft, this enables to store information on over 40 parameters for 25 hours of flight, with a variable sampling sequence between 0.25 and 8 times per second, depending on the parameter.

1.11.2. Condition of the recorders

The CVR was removed from its housing, at the back of the fuselage on the right-hand, immediately after recovery of the wreckage, on August 28th, 2005.

However, the FDR was located on the bed of the sea, away from the fuselage, and was recovered on August 30th, 2005.



Photo 16: The recovered FDR (foreground) and CVR.

The two recorders were washed immediately using fresh water and then placed in distilled water, where they were kept until opened, on September 10th, 2005, at the ANSV laboratories.



Photo 17: Preservation of the FDR and CVR in distilled water.

Both units were in reasonable general condition, without evidence of impact or fire damage.



Photo 18: CVR, external condition. ULB in foreground.

In particular, the tapes were properly positioned in their housings. Both were showing traces of contamination from sea water, mud and oily substances. However, during the disassembly and the removal of the tapes, a strong adhesion to the recording heads was noted. Extreme care was therefore necessary to detach them.

The examination of the CVR tape showed the presence of two joins, in addition to the one that would normally be expected. One of them had been wrongly positioned on the recording side. In view of its length (approximately 1.2 cm) and the speed of the tape (equal to 4.8 cm per second), this seam has caused the loss of approximately 1/4 of a second of recording time.

A research has been carried out to assess the origin and the maintenance history of the A100A S/N 62067 CVR. It was found that the CVR entered the TS-LBB operator-managed parts logistic system at the end of 2001, upon termination of a leasing agreement with a British company involving one of their ATR 42s. In February 2003 the CVR was sent for servicing to an approved company and subsequently installed on the TS-LBB aircraft on February 23rd, 2005.

1.11.3. Data reading and decoding operations

After cleaning and drying the two tapes, the CVR tape was played back and the four audio tracks were acquired. A *.wav format file of good quality was obtained.

The FDR tape was also played back. The waveform was converted into a binary code and the data was acquired. This process resulted in 6 files, one for each track, of so-called raw data. The raw data were then processed and converted into engineering units (kt, ft, degrees, etc.) associated to the single parameters, on the basis of the document configuration (data frame layout) supplied by the user and by the manufacturer. The data relating to the flight that ended with the accident were then identified; they were recorded on track 1 and contained data corresponding to about 4580 seconds (from power up to impact). In such interval there were 37 missing subframes (each subframe is equal to 1 second of data). The resulting synchronization rate was 99.2%.

It was then necessary to process the data further, to correct some mistakes caused by the low quality recording of this type of FDR; the quality of the recording is in fact influenced by factors such as tape advancement speed changes, vibrations and increase in the distance between the recording heads and the tape.

The validity of the acquired data was then assessed. The last data considered valid were recorded at 13.35.39 UTC (FDR time), approximately one minute before the impact of the aircraft with the water surface.

Attachment “H” shows some graphs of the most significant parameters of interest.

1.11.4. CVR, FDR and ATC data synchronization

The sequence of event has been reconstructed based on information obtained from several sources (recording of the Palermo APP G/A/G communications, FDR and CVR data, radar data supplied by Brindisi ACC etc.), each using a different time reference.

It was therefore considered appropriate to use, as a common point of reference, the UTC time of the Palermo APP G/A/G (in Italian T/B/T) communications.

The synchronization between the FDR data and Palermo APP UTC time was obtained by correlating the activation of the MIC VHF button (parameter recorded by the FDR) and the corresponding G/A/G communications made by the crew and recorded by the ENAV SpA equipment. The two times are connected by the following relationship:

$$t_{(APP PA)} = t_{FDR} + 1'28''$$

The correlation between the ENAV SpA radar data, supplied by Brindisi ACC, and the FDR data has been obtained by comparing the altitude curves based on the time. The best overlapping of the two curves can be obtained with:

$$t_{(ACC BR)} = t_{FDR} + 1'42''$$

The following table gives a simple explanation of the time correlation of some significant events.

$t_{(APP PA)}$	t_{FDR}	$t_{(ACC BR)}$	G/A/G communication	Notes
13.24.50	13.23.22	13.25.04	<i>Raisi APP TUI 1153 with you.</i>	First contact with Palermo APP.
13.29.35	13.28.07	13.29.49	<i>Is there any other terrain please nearest than that?</i>	Request of an alternative airport closer than Palermo.
13.34.00	13.32.32	13.34.14	<i>I think are we are not able, we are not able to reach the terrain. We are 4.000 ft and we are not able..... we lose both engines. Can you send for us helicopters or something like that?</i>	The crew informs that they are unable to reach Palermo.
13.36.25	13.34.57	13.36.39	<i>Unable to reach the field, Tuninter 1153. Unable to reach... the field. We have two boats on the left side...big boats, we'll try to land...to ditch near them... if you can call them, please.</i>	Last MIC activation recorded by the FDR.
13.37.08	13.35.39	13.37.21		Last valid data recorded by the FDR.
13.38.05	13.36.36	13.38.18		End of CVR recording.

Table 7: Time correlation of some events.

The synchronisation between the audio tracks of the CVR, the FDR data and the G/A/G communications required further processing of the audio files, necessary to correct the time distortion of the duration of the recording caused by the deviation of the CVR power supply frequency compared with the nominal value (400 Hz, 115 VAC).

1.11.5. Significant elements emerged from the analysis of the CVR and FDR

The evidence emerged from the CVR in relation to the conversations and sounds recorded inside the cockpit, have been useful in reconstructing the facts, as outlined in paragraph 1.1. All times have been based on Palermo APP times.

The FDR starts showing data recording anomalies at 13.34.54 UTC (approximate aircraft altitude 3,000 ft).

The last data considered reliable were recorded at 13.37.08 UTC (altitude: 728 ft). Starting from that point until the moment of the impact, the only available data on the flight path of the aircraft were obtained from the radar data, with all the approximations that this type of information entails. It is believed that the interruption of the FDR recording was due to the depletion (voltage decrease) of the main battery, as seen previously.

However, recording by the CVR terminated at 13.38.05 UTC (ATC time). This is the moment it is believed that the impact with the sea surface occurred.

Animated reconstruction of the event

Thanks to software used by the ANSV laboratories, it was possible to produce an animation of the flight in question, starting from the moment it took off at Bari, to the moment of ditching. In particular, some of the instruments of the cockpit have been replicated, including the fuel quantity indicator. For the latter two images have been produced, with the wording “*Indicated*” and “*Actual*”, representing the quantity of fuel indicated by the FQI and the quantity actually present inside the wing fuel tanks respectively. FQI indications are computed and not recorded by the FDR. All displayed flight parameters are those recorded by the FDR. The video-stills shown below represent what has just been described.

Note: *The animation is based on FDR data and its intended purpose is to help understanding the event. Any conclusion based on this animation should be reviewed in light of the manner in which it was produced.*



Figure 11: Aircraft ready for takeoff on threshold of runway 07, Bari airport



Figure 12: Aircraft after takeoff.



Figure 13: Right engine shut down.



Figure 14: Aircraft during the descent with both engines shut down.

Some “.avi” files have also been created (Attachment “I”), which can be played back using commercial software, representing the various types of animated reconstructions, starting from takeoff from Bari until ditching of the aircraft.

1.12. WRECKAGE AND IMPACT INFORMATION

1.12.1. Geographical position of the wreckage

The central section of the aircraft (LH and RH wings, engines and part of the central fuselage), which remained floating on the sea surface, was recovered on the same day of the event, at the following geographical coordinates: Latitude: 38° 24'.16 N and Longitude: 013° 27'.30 E.

As already stated in the previous paragraph 1.3., following the impact with the sea surface, the aircraft split into three main sections (see Figure 6). From the statements collected from the passengers and the evidence given by the crew of the air rescue services, which arrived on location 25 to 30 minutes after ditching, it was established that although split into three parts, the whole wreckage was partially submerged (at a depth of approximately 2 to 3 metres), with the wings visible above the water level.

This was also confirmed by the B737 aircraft flight captain, who flew over the area where the event took place, giving Palermo control tower the position of the wreckage. Photo 19, taken by the first helicopter arriving on the scene, clearly shows the rear of the aircraft on the sea surface, together with the LH and RH wings. The nose of the wreckage is oriented at 040°/050°.



Photo 19: View of the wreckage upon arrival of the first rescue helicopter.

After 30 to 35 minutes, before the arrival of the sea rescue services, the front and rear sections sank, while the central part remained afloat. Some passengers climbed on top of the LH and RH wings, where they remained until the arrival of the rescue services. It should particularly be noted that the tail cone became detached due to the impact; it remained afloat and was subsequently recovered.

Table 8 shows in details the coordinates of the wreckage position, as formally reported in the documentation given to ANSV, together with the UTC time of reference and the FDR, during the various stages of interest.

Date	LATITUDE (N)	LONGITUDE (E)	TIME (UTC)	Notes
August 06 th , 2005	38° 24'.110	013° 29'.4	13.52	Coordinates communicated by TWR to 12°MRSC – Operations Room of the Capitaneria di Porto
August 06 th , 2005	38° 24' 29"	013° 30' 31"	13.57.45	Coordinates communicated from TWR to the B737 taking off from Palermo after the ditching of the TS-LBB
August 06 th , 2005	38° 23' 35"	013° 27' 01"	14.10	Coordinates established by helicopter "118", marks I-BRMA. First helicopter arriving on the scene of the event. The rear section and the front part of the fuselage were still floating.
August 06 th , 2005	38° 22' 51"	013° 28' 08"	15.26	Update of the coordinates provided by helicopter "118" The wreckage moves SE
August 28 th , 2005	38° 23.48	013° 27.60	-----	Position of the wreckage (rear fuselage and tail) at the bottom of the sea; approximate depth 1500 metres. In the nearby have been found various parts of the wreckage, including the cockpit. Data provided by Italian Navy.
August 29 th , 2005	38° 23.42	013° 27.15	-----	FDR position. Data provided by Italian Navy.

Table 8: Geographical coordinates of the wreckage and FDR.

The position of the wreckage call for a distance from the coast line within national waters, as determined by Italian Navy and Ministry of Transport – Capitaneria di Porto di Palermo.

1.12.2. Recovery of the wreckage

The central section, comprising the LH and RH wings, part of the fuselage and the engines, was recovered on the same day of the event by the port authorities, with the coordination of the Capitaneria di Porto. Following recovery, it was provisionally placed on a wharf of the port of Palermo (from photo 20 to 23), and later on moved to a hangar of the Palermo Bocca di Falco

military airport and held, together with the other parts of the wreckage recovered from the bottom of the sea. The wreckage was impounded by the competent judicial authority. All technical assessments carried out on its parts, including any components, were coordinated by technical consultants appointed by the same judicial authority. ANSV personnel were permitted to attend, as observers, most of the investigations subsequently carried out. The specific details of the coordination with the judicial authority are detailed in the following paragraph 1.18.1. of this report.

1.12.3. Visual inspection on the wreckage

The first visual inspection of the LH and RH wings and engines, with part of the central fuselage, was carried out at the port of Palermo immediately after recovery.

The remaining parts of the wreckage were also inspected immediately after recovery from the bottom of the sea: rear and front section of the fuselage, including the cockpit.

Further inspections were carried out after the wreckage was moved to a hangar of the Palermo Bocca di Falco military airport.

From the above inspections the following emerged.

Inspections carried out on the wharf of the port of Palermo, immediately after the recovery of the central section

LH and RH wings, engines and part of the central fuselage.

The bottom part of the wreckage had large rents. The main landing gear had come out of its housing and was showing several breaks caused by the impact.

The LH and RH wings appeared intact and no signs of impact with the sea surface and/or clear damage were found. The central section of the fuselage was severed along two break lines and did not show any traces of fatigue and/or corrosion.

Central section of the fuselage

- Main landing gear in the extended position
- Most of the hydraulic system components present.
- Both up-lock boxes (LH and RH) in the open position.

RH wing

- Spoiler in the extended position.
- Flaps retracted (0° position).
- Part of the flaps and the leading edge were damaged during the recovery operations, when the wreckage was moved from the point of recovery to the port of Palermo by towing through the water.

- Both the inner and outer dripsticks (magnetic graduated rod used to check the quantity of fuel inside the wing fuel tanks) appeared in good condition.
- Gravity refuelling point in good conditions: no corrosion and filter in good condition.
- Panel opening area for access to the Feeder Tank: no contamination detected, presence of water and fuel (or at least of two fluids with different densities) inside the tank. No visible damage to the internal pipes.
- Presence of water inside the wing fuel tank possibly penetrated from the NACA air vent (underside of the wing) during the period in the water after ditching.



Photo 20: Part of the central fuselage with LH and RH wings.

LH wing

- Spoiler in the extended position.
- Flaps retracted (0° position).
- 2/3 of the aileron tab damaged.
- Inner magnetic dripstick inaccessible due to the positioning of the wreckage on the ground. Outer magnetic dripstick broken, its reading regarded as inaccurate.
- Part of the flap and the leading edge were damaged during the recovery operations as for the right-hand wing.
- Gravity refuelling point in good condition: no corrosion and filter in good condition.
- Presence of water inside the wing fuel tank possibly penetrated from the NACA air vent (underside of the wing) during the period in the water after ditching.

Left engine (no. 1) – Right engine (no. 2)

- Considerable presence of corrosion on various components, caused by the action of the seawater they came into contact with. The engines were immediately treated with fresh water to limit any further corrosion to the components.
- Some of the propeller blades, resting on the ground, were clearly bent.
- MFCU Fuel Control in the shut-off position.
- No visible loss of fluids from components and accessories.
- No clear breaks in the fuel feed line.
- Low pressure filter removed to check its condition. No external contamination was detected.



Photo 21: Right engine – note the propellers in the fully feathered position (red line).

During the execution of the operations, samples of fluid from the wing fuel tanks and engine oil were also collected by the competent judicial authority, for subsequent laboratory testing purposes.

Both Electronic Engine Control (EEC) boxes were also removed for the decoding of the information contained, which may relate to a possible engine failure.



Photo 22: Part of the central fuselage with LH and RH wings at the Port of Palermo.



Photo 23: Part of the central fuselage with LH and RH wings at the Port of Palermo, the central section.

Inspection carried out after recovery of the rear and front sections of the wreckage

The wreckage recovery operations are described in detail in paragraph 1.15.1.3. On August 28th, 2005, at approximately 22.30 local time, most of the remains of the aircraft were recovered. These included:

- a) Tail section, approximate length 11 metres, including horizontal and vertical tail assemblies. A large gash in the bottom section was clearly visible from the outside. The end part of the tail cone was missing. It had in fact already been recovered by the rescue team from the sea surface on the same day of the event.



Photo 24: Positioning of the wreckage on the ship's deck



Photo 25: Remains of the wreckage on the ship's deck after recovery.

Considerable structural damage was found on the inside. The pressure bulkhead between the cabin pressurized zone and the tail had a large diagonal gash (see photo 34 and 61). The tail assemblies did not show any significant deformation. The CVR was removed from its housing. It was removed, immediately washed with fresh water and then placed in a container full of distilled water. The supports of the FDR housing appeared damaged and the device itself was missing (photo 61).



Photo 26: CVR in its housing inside the aircraft.



Photo 27: CVR in distilled water, after being recovered from the aircraft.

As described later, the FDR was located and recovered from the bottom of the sea. Also the FDR was washed and placed in distilled water immediately after being recovered, in order to prevent corrosion affecting the quality of the recorded data. Both recorders were then placed under sequestration by the competent judicial authority.

b) Cockpit and part of the front fuselage. The cockpit was extensively damaged, compressed and deformed, making access to the inside practically impossible. An initial inspection, carried out as soon as it became possible to enter the wreckage, provided the opportunity to assess the position of some controls and the indications of some of the most significant instruments.

In particular:

- ADI (horizon) stand-by: approximately $13/14^{\circ}$ UP and minimal inclination to the right (approximately $2/3^{\circ}$);
- Altimeters: 10 ft (flight captain left-hand), 6780 ft (co-pilot right-hand);
- Anemometers: 115 kts (flight captain left-hand), bottom scale of instrument (co-pilot right-hand);
- Stand-by altimeter: 3000 ft;
- Stand-by anemometer: 0 kts;
- Power Levers: $\sim 45\%$ left (LH), $\sim 50\%$ right (RH);
- Condition Levers: MIN RPM LH ; $\sim 50\%$ RH;
- Clock: left-hand 13.39'18"; right-hand 13.47'00";
- Flaps position indicator: $\sim 0^{\circ}$;
- Landing gear lever: UP (landing gear in the retracted position).

The control column was completely deformed and the seats in the cockpit were completely destroyed.

Photo 28, taken immediately after positioning the wreckage on the deck of the ship, shows in fact that the lever of the landing gear was in the UP position. It was also found after removal that the flaps position analogue indicator was showing 30° .



Photo 28: part of the TS-LBB instrument panel after recovery
(note the landing gear lever in the “UP” position at the centre of the photo).

The Fuel Quantity Indicator was still in its housing inside the cockpit. Photo 29 shows the front part of the instrument with the writing 2250 kg, which indicates the maximum fuel capacity of each wing fuel tank. In effect the indication of 2250 kg relates to indicators used by the ATR 42 models. Subsequent checks did in fact confirm that the FQI installed was a model intended for ATR 42 aircraft.



Photo 29: The FQI installed on the TS-LBB - video still taken immediately after recovery.

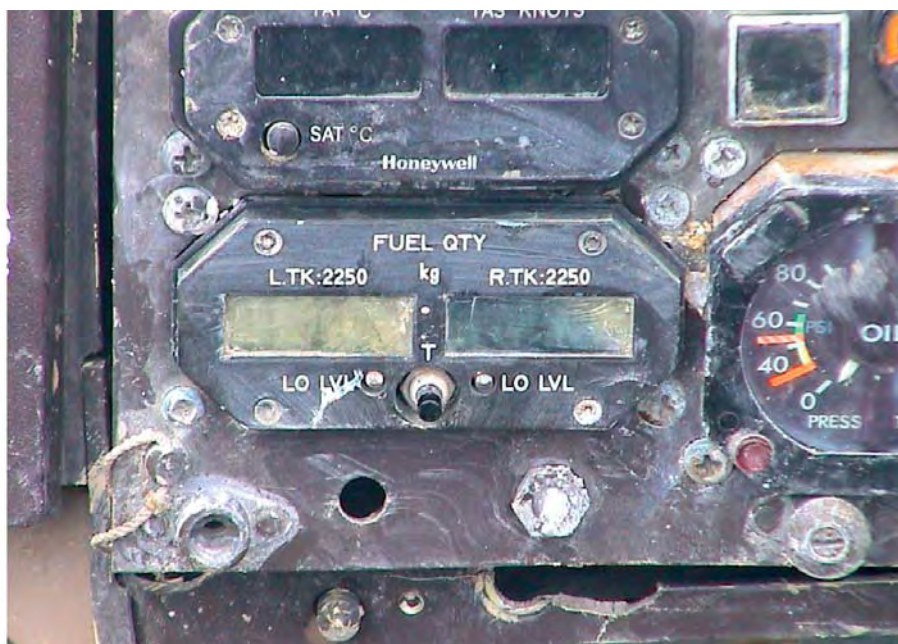

Photo 30: FQI front panel recovered from the wreckage. Note the inscription “2250” corresponding to an ATR 42 type FQI.

Examination of the wreckage after recovery and in storage at the Bocca di Falco military airport

Rear or tail section

No specific tests have been carried out on the structural parts of the wreckage. Most of the break points showed the typical overload stress characteristics. No evidence of fatigue and corrosion was detected. As already indicated, as far as the rear section is concerned, breaks are localized by the severed section, connected to the remaining part of the aircraft fuselage. No signs of damage were detected in the tail section.



Photo 31: Part of the wreckage inside a hangar at Bocca di Falco.



Photo 32: Rear section of the wreckage at Bocca di Falco airport – left-hand view.

The rear of this section showed a great amount of damage and deformation, resulting in the breaking of the pressure bulkhead between the pressurised and the non pressurised zone. This indicates that the impact of the aircraft against the sea surface was very strong. The rear had in fact completely collapsed, while the seating area was virtually intact.



Photo 33: Rear of the wreckage at Bocca di Falco airport, right-hand view.

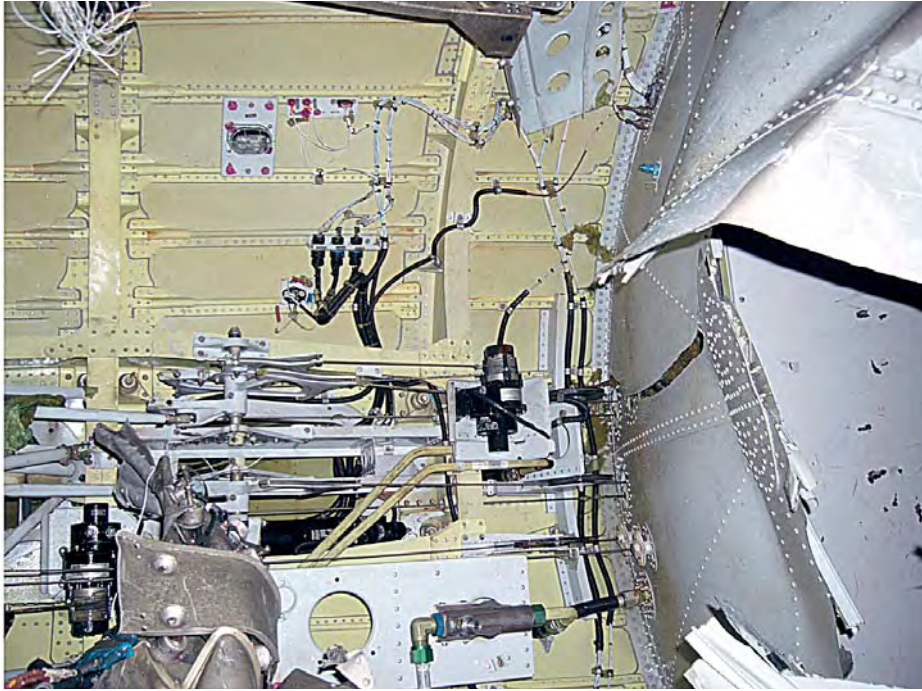

Photo 34: Rear of the aircraft, inside view. Note the deformation of the pressure bulkhead.



Photo 35: Interior of the passenger cabin.

Together with the evidence given by some passengers occupying the back rows, who remember hearing a loud impact and then being immediately surrounded by water, the scene encountered indicates that the rear of the aircraft might have been the first to impact against the water surface, separating from the rest of the structure due to the strong induced bending stress.

Central section

The central section, also including the engines, as previously stated, was recovered on the same day of the event by the Capitaneria di Porto and placed on a wharf of Palermo port for a few days, before being moved to a hangar of Palermo Bocca di Falco airport. No fire damage was detected. In this section were also the corresponding part of the fuselage and the main landing gear. An initial examination of the landing gear showed that this was in the extended and locked position. However, the type of damage found was not compatible with this position. It is very likely that the landing gear moved to the extended position following the strong impact and the detachment of the central part of the fuselage from the rest of the aircraft.

Also this section shows no evidence of breaks due to fatigue and/or any corrosion. All sections show breaks typical of overload.

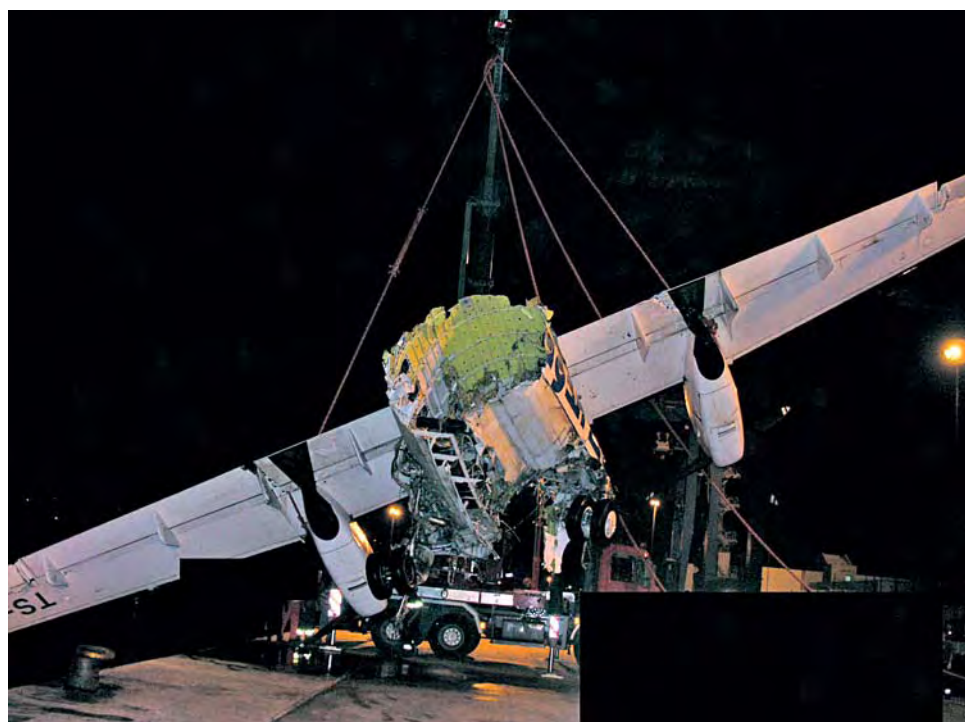

Photo 36: Central section of the wreckage, with LH and RH wings, during recovery.

The right-hand appeared more deformed than the left-hand, indicating that the right-hand of the aircraft had suffered a stronger impact. The seats on this side were in fact no longer attached. From the evidence, it appears that the central section strongly impacted against the sea surface. The strong bending stresses caused by such impact caused the structure to separate from the rest of the aircraft at the point of the main landing gear and the wing structure.

Front section

This section was divided into two parts. One part included the cockpit and the left-hand structure, while the other included the right-hand structure and the top part of the cabin. Also in this section no evidence of breaks due to fatigue and/or corrosion were found. All breakage points showed in fact a morphology typical of breaks caused by overload. No signs of fire were detected either. The section of the cockpit showed serious and extensive damage. It is very likely such damage was caused not only by the impact with the sea surface, but also by the subsequent impact with the seabed.



Photo 37: Part of the cockpit immediately after recovery.

Of the three occupants that were in the cockpit at the moment of ditching (the two pilots and the engineer), the pilots suffered injuries that were in fact not as serious as one would have expected considering the condition in which the cockpit was found, after being recovered from the sea bed (see photos 37 and 38). It is therefore highly possible that most of the deformation found on the front part of the aircraft might have been caused by the impact with the sea bed, as well as the subsequent impact of the tail section against the cockpit itself.

The internal structure of the right-hand of the aircraft showed an extensive amount of damage. The seats and the floor were no longer attached.



Photo 38: Part of the front section of the fuselage immediately after recovery.

Considerations

From the evidence, it appears that the central section strongly impacted against the sea surface. The strong bending stresses caused by such impact caused the structure to separate from the rest of the aircraft at the point of the main landing gear and the wing mounting. The violence of the impact was also confirmed by the evidence given by the two pilots. The flight captain remembers being immediately thrown out of the cabin as soon as the impact occurred, while the co-pilot remained in his seat, with the seat belt on and said that he found himself underwater. He was then able to free himself, with the cockpit partially submerged, and resurface.

1.13. MEDICAL AND PATHOLOGICAL INFORMATION

All flight and cabin crew members had undergone and passed their regular medical checkup. Below is a summarized description of the injuries suffered by the occupants of the aircraft (crew and passengers). Paragraph 1.15.3. gives a more detailed description of the injuries suffered by the passengers, correlated to their position in the aircraft before ditching.

Flight crew and airline engineer

The flight captain and the co-pilot suffered serious injuries, while the engineer, who was inside the cockpit at the moment of ditching, suffered fatal injuries. Although he was not part of the

flight crew, the engineer had been called to the cockpit by the flight captain after both engines had failed, hoping he would be able to provide some solution to the failure.

Flight attendants

At the moment of ditching, both flight attendants were in their seats. The senior flight attendant, seated at the rear of the aircraft, suffered fatal injuries, while the flight attendant, seated at the front of the aircraft with her shoulders facing the cockpit, suffered serious injuries.

Passengers

Of the 34 paid passengers on the aircraft, all of Italian nationality, 14 suffered fatal injuries, while the remaining 20 suffered from serious to minor injuries.

1.14. FIRE

No fire occurred to the aircraft or any of its parts or components, either before or after the impact with the sea surface.

1.15. SURVIVAL ASPECTS

1.15.1. Search and recovery of the wreckage

1.15.1.1. General considerations

As already indicated, the impact caused the aircraft to split into three sections. The front section (part of the fuselage and cockpit) and the rear section (part of the fuselage and tail section) sank to the bottom of the sea 45 to 50 minutes after ditching. The sea in the area is approximately 1500 metres deep. The aircraft recorders, installed in the tail section, were therefore inaccessible. ANSV, after establishing the necessary level of collaboration with the competent judicial authority, contacted the President of the Council of Ministers to request the financial resources and the technical means for the recovery of the missing people, the aircraft recorders and the wreckage. Direct interfacing was also ensured with the Italian Navy, still in coordination with the competent judicial authority, to ensure, as far as the identification and preservation of the findings were concerned, that the recovery operations received the necessary level of support.

1.15.1.2. Operations carried out by the Italian Navy for the location of the wreckage

The operations for locating the wreckage were supervised by the Italian Navy. By using the ocean research ship “Ammiraglio Magnaghi” (hereinafter called also Magnaghi) and the ship *Universitatis*¹⁴, the Navy was able to locate the main parts of the wreckage. The two aircraft recorders (FDR and CVR) were also located, thanks to the detection of the signals (37.5 KHz) emitted by their ULB (Underwater Locator Beacon).



Photo 39: The “Ammiraglio Magnaghi”.

The Magnaghi received the preparation order the day following the event, leaving the port of Taranto, where it was berthed, at 20.20 local time. The ship reached the area of the operations, approximately 12 nautical miles from Capo Gallo and 24 NM from Palermo Punta Raisi, on August 9th, 2005. The operations started at the point where the central part of the aircraft was recovered (LH and RH wings and nacelles), geographical coordinates 38° 24'.16 N and 013°27'.30 E. This position was compatible with the position given by the control tower of Palermo airport to the Capitaneria di Porto.

¹⁴ This ship was made available by the Consorzio Interuniversitario per le Scienze del Mare. It was purposely transferred to Palermo on August 14th 2005, with the coordination of the Italian Navy, to be used as the vector for the Side Scan Sonar.

The rescue operations were concentrated across a square surrounding the position where the LH and RH wings and nacelles were recovered. The Magnaghi was also made responsible for supporting the search and rescue activities coordinated by the Capitaneria di Porto of Palermo. The search and location operations for the wreckage were started on August 9th, at 05.30 local time and ended on August 12th, 2005 at 15.00 local time. For the duration of the operations meteorological conditions were good, which meant that the planned activities could be completed normally. Figure 15 shows the areas where the research operations took place.

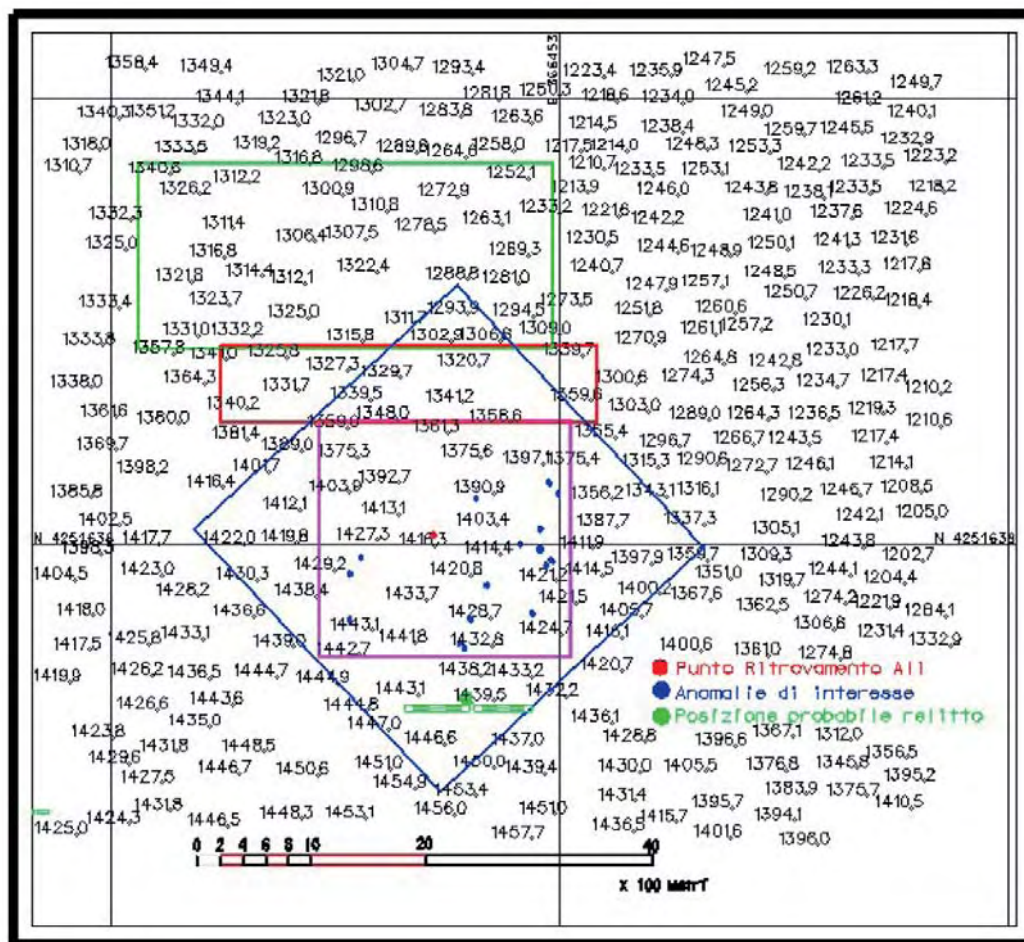

Figure 15: Areas covered by the search activities.

1.15.1.2.1. Planning of the operations

In planning the search operations, the following information and criteria were taken into account.

- Indication of position where the central part of aircraft was found;
- Direction followed by the aircraft just before ditching;

- Sea conditions and estimate of the currents in the area the moment the event took place, for the identification of the most probable area where the wreckage might have sunk.
- Characteristics of the instrumentation on board which could be used for conducting the search operations. These will be explained in details in the following paragraph.
- Characteristics of the signals coming from the ULBs fitted on the flight recorders (FDR and CVR) of the aircraft: frequency 37.5 KHz, range 2 NM, ping rate 1 Hz, maximum duration of battery 30 days, if in good condition;
- Dimensions of the various missing parts of the wreckage;
- Sea conditions inside the operations area;
- Bathymetry¹⁵ of the area.

1.15.1.2.2. Instruments and techniques used

In line with the operating capabilities of the Magnaghi, the primary duty assigned entailed the identification of any anomalies in the bathymetry that could be linked to the remains of the wreckage. First of all, a mapping of the sea bed was completed to define the planimetric and tridimensional level of the seabed. This would also be used for the subsequent stage, to be carried out using systems such as towed side scan sonar, and remotely operated underwater vehicles (Remotely Operated Vehicle - ROV) fitted with a video camera.

In order to make the most of the search capability of the on board hydrographical systems (single and multibeam acoustic sounders) and ensure at least the minimum of manoeuvrability conditions, the speed of the ship was kept between 3 and 6 knots.

Patrolling was also carried out in the area of the hydrographical activity, using small ship-borne craft to complement the operations for the search for missing persons and any floating wreckage.

In consideration of the bathymetry of the accident area, characterised by a depth of 1500 metres, the instrumentation used was limited to single and multibeam acoustic sounders. Although available on the ship, the Side Scan Sonar was not used due to its maximum operating depth being 600 metres.

It was decided that a full search of the seabed should be carried out using the multibeam acoustic sounder, with a 50% overlap area between the lines, to eliminate any spurious data collected by the lateral lobes of the multibeam system (figure 16).

¹⁵ Bathymetry is a branch of oceanography dealing with the measurement of the depth, the graphic representation and the study of the morphology of sea and lake beds.

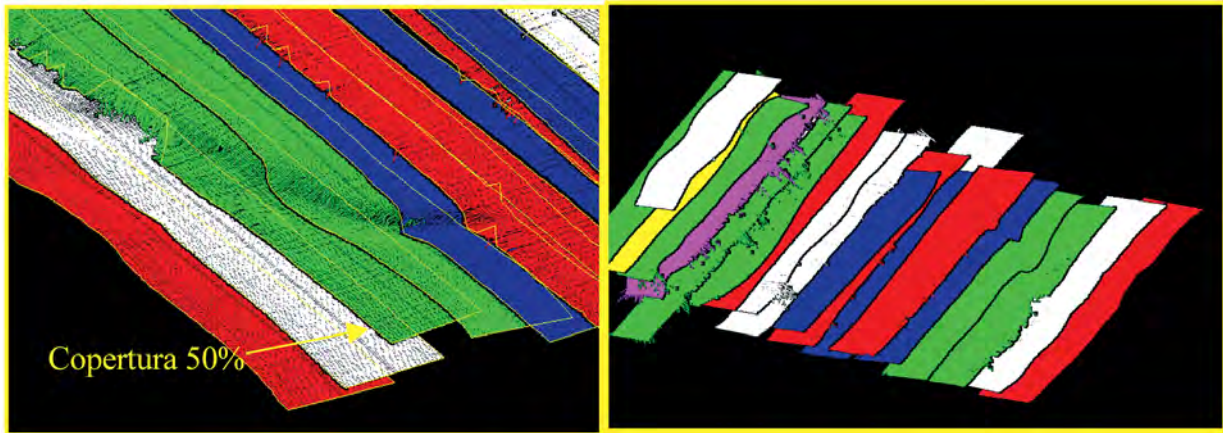

Figure 16: Bands covered by the multibeam acoustic sounder.

The acquiring of data using the multibeam acoustic sounder was aimed not only at the search activities, but, most of all, also to the operations for the definition of the bathymetry of the area. The area of the survey was enclosed inside a 10 NM square, with its centre being the point the central section of the airplane (LH and RH wings and engines) was recovered. Inside this area the search entailed moving the soundings across parallel lines 1000 metres apart following an east to west direction and *viceversa*.

In order to find any abnormalities in the bathymetry that could be connected with the aircraft, a single beam system was also used at the same time. The search operations using the single beam were concentrated on a 2.5 km square, with the centre also being the point some of the aircraft remains were found. In this case the search was carried out moving the soundings across parallel lines 100 metres apart following north to south and east to west directions, and vice-versa. In addition to looking for any abnormalities (presence of parts on the seabed), this square (2.5 km each side) was also scanned for emissions from the flight recorders. The emission frequency of the recorders is in fact similar to the working frequency of the single beam acoustic sounder (38 KHz).

As far as the technical characteristics of the instruments used for the search operations is concerned, the traditional scanning method using an acoustic sounder emitting a unidirectional beam (singlebeam) was integrated with the use of a sonar capable of emitting multiple unidirectional beams (multibeam).

- Acquiring of depth data:
 - ELAC BOTTOMCHART MKII (50 KHz) Multibeam acoustic sounder.
 - SIMRAD EA 600 (38 KHz) Singlebeam acoustic sounder.

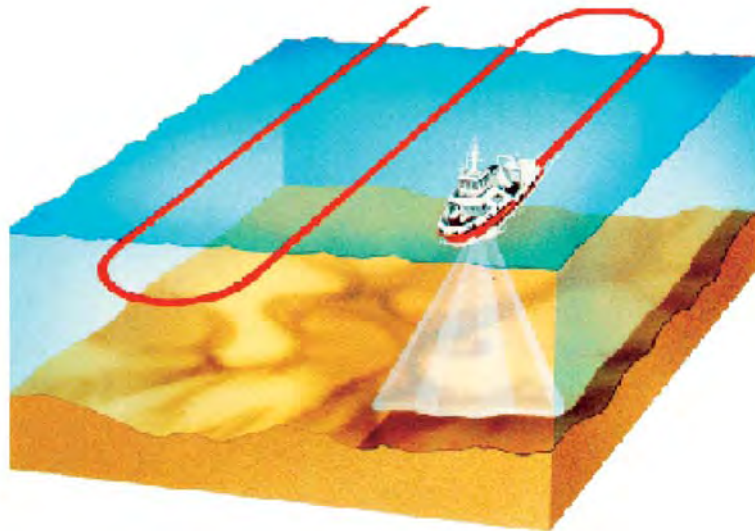

Figure 17: Path followed by the acoustic sounder.

- Positioning system:
 - Differential GPS CSI Max Wireless with Omnistar corrections enabled.

- Data acquiring and processing:
 - Hydrostar multibeam data acquisition system;
 - Pangea D4S hydrographic data acquisition system;
 - “*Pangea Verifica*” processing system for the analysis of singlebeam data;
 - “*Pangea Multibeam Manager*” processing system for the analysis of multibeam data.

- Systems for the calibration of the speed of the sound:
 - Idronaut Ocean Seven 316 bathyprobe and dedicated software;
 - XBT Sippican MK 12 system and dedicated software.

Smaller nautical craft, such as rubber dinghies and hydro boats, were also used for patrolling and for the recovery of any floating objects that could be connected with the ditched aircraft. This was done to support the operations for the search for missing persons and floating wreckage. In particular, on August 9th the MBN 1189 hydro boat was used for a period of 9 hours, for day-time patrolling of the area between parallels $38^{\circ} 24'.20 \text{ N}/38^{\circ}13'.80 \text{ N}$ and meridians $013^{\circ}27'.30 \text{ E}/013^{\circ}39'.20 \text{ E}$.

1.15.1.2.3. Main results

The hydrographical acquisition using the multibeam acoustic sounder, carried out in accordance with the procedure described above, together with the subsequent processing of the acquired data, including a 3-D model of the seabed, enabled full coverage of the seabed area involved. A full mapping was obtained of the seabed at the bottom of the 10 km square area centred on the point where the central part of the wreckage (LH and RH wings and engines) was found. Inside the restricted restricted area measuring 2,5 km each side, centred on the same point, a larger scale bathymetry was also completed with the aim of optimizing the use of submersibles.

The scanning operations enabled to identify some abnormalities, particularly the presence of parts which were not compatible with the type of seabed. These were the starting point for the subsequent search stage, carried out using side scan sonar. These needed to be placed underwater and towed using underwater ROVs.

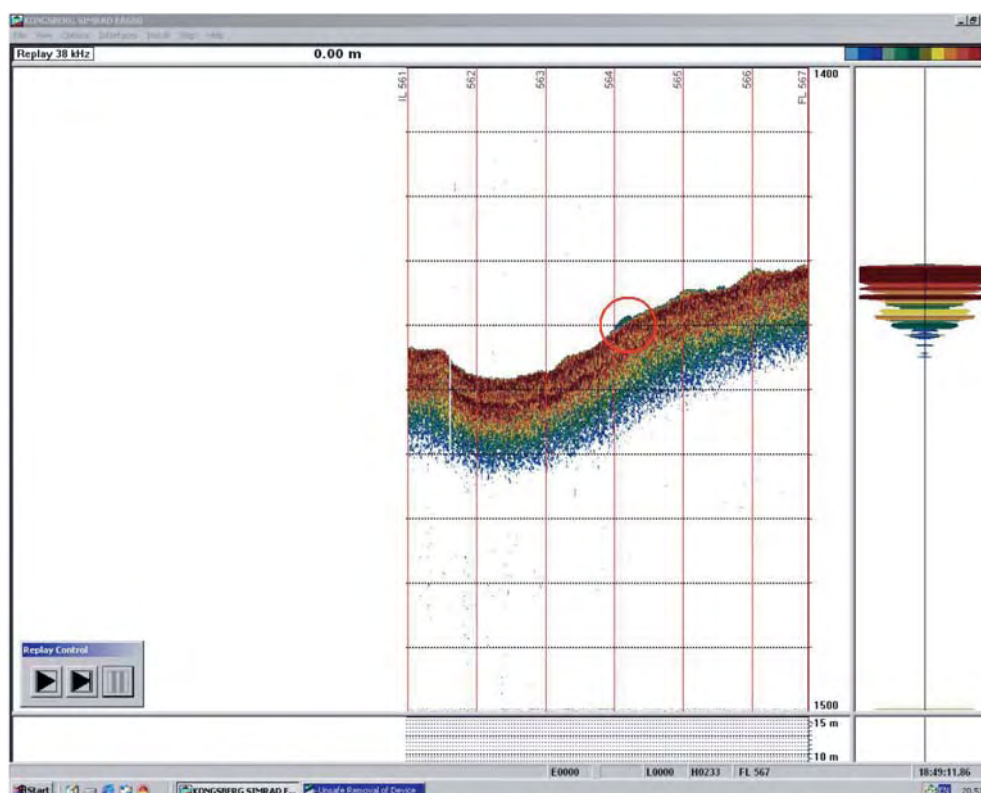

Figure 18: Abnormalities on the seabed.

During this first part of the operations for the search for the wreckage (August 9th to 12th, 2005), the frequency emissions from the flight recorders were not detected. The certainty about the possible presence of the wreckage in one of the anomalies detected was only confirmed after optical investigation carried out using video cameras mounted on ROV type submersibles (see following paragraph 1.15.1.3.).

The subsequent search stages were mainly concerned with finding the flight recorders and various parts of the wreckage (activity carried out in the period between the 16th and the 19th of August, 2005), with the support of the *Universitatis*, fitted with a KLEIN 3000 Side Scan Sonar, as well as a single beam acoustic sounder (38 KHz transducer, compatible with the signal emitted by the FDR and CVR beacons) and a multibeam acoustic sounder.

The data acquired using the singlebeam acoustic sounder, at full seabed coverage in the area 3x1.5 km north-west of the point the aircraft was believed to have ditched, gave the possibility to exclude the presence of any bathymetric anomalies, both morphological and acoustic, which could be associated with the wreckage. The search operations were then extended to the southeast area, using the 38 KHz acoustic scanner, with the aim of locating the flight recorders. A consistent sound activity could be detected in this area. This was cyclical and regular, and could be linked with a seabed anomaly the size of which was compatible with the missing parts of the wreckage: tail and front part of the fuselage.

In addition, the use of the Side Scan Sonar, mounted on the *Universitatis*, also confirmed the presence of a seabed anomaly which could be connected, for shape and size, with the remains of the aircraft.

In specific terms, the following 2 contacts were identified, positioned at a distance of 89 metres, with the following geographical coordinates:

- 38° 23' 26.40''N - 013° 27' 40.90'' E (object made of two parts, with lengths of 10 and 4 metres respectively, being the probable position of the tail section and front part of the fuselage with cockpit);
- 38° 23' 24.18'' N - 013° 27' 42.78'' E (object approximately 4 metres long, being the probable position of a fuselage panel).

1.15.1.3. Wreckage recovery operations

1.15.1.3.1. General

The recovery operations took place between August 26th, 2005 and September 2nd, 2005. They were completed by the company Phoenix, which had been appointed by the Italian Navy. The ship used for the support of instrumentation and equipment, was the EDT ARES, under the Cypriot flag and specialized in these kind of operations. The technical personnel involved were Phoenix staff. The ROV REMORA 6000 was used, capable of carrying out recovery operations down to a depth of 6000 metres.

The Remora 6000 is part of a class of submersibles of 25 hp, built for remote underwater operations in the search for objects and their location, identification and recovery down to a depth of 6000 metres.

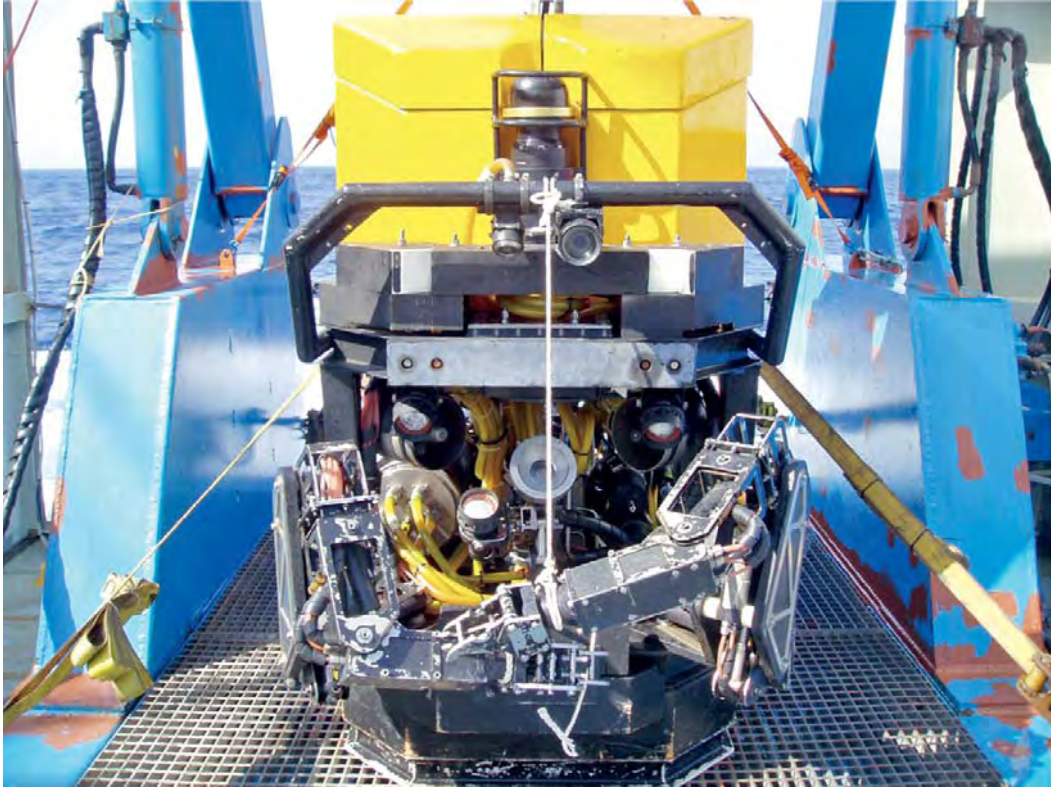

Photo 40: ROV Remora 6000, front view.

This submersible is small in size, can be easily manoeuvred and is easy to transport. It is fitted with a forward looking sonar, a light system, three video cameras and two mechanical handling arms (with six functions) that, thanks to a remote control system, enable the collection of seabed samples, recovery of objects and execution of a number of operations on the seabed.

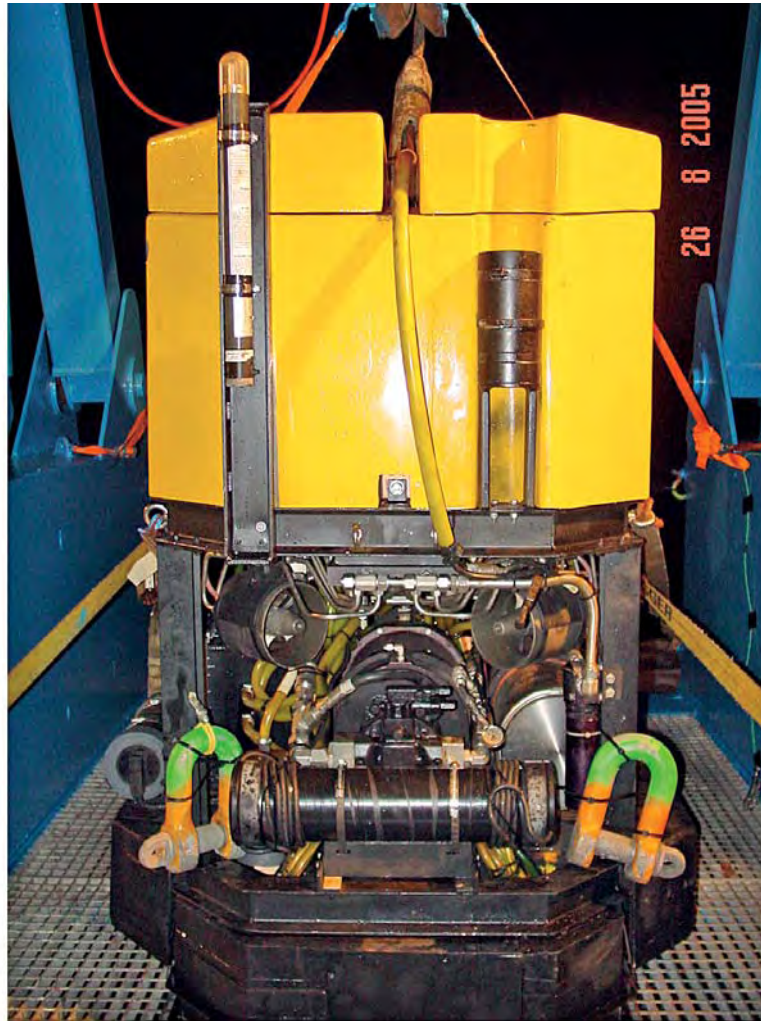

Photo 41: ROV Remora 6000, rear view.



Photo 42: ROV Remora 6000, side view.



Photo 43: ROV Remora 6000, launch/submersion phases.

The ship telemetry system is able to support a variety of video systems that reproduce the images shot by the three video cameras mounted on the ROV system (see photo 44).



Photo 44: Video system reproducing the images from the video cameras mounted on the ROV.

The “Ammiraglio Magnaghi”, always stationed at the site of the operations, was used both to provide support to the recovery operations carried out by the EDT ARES and for the patrolling of the sea area.



Photo 45: The “Ammiraglio Magnaghi” on the left and the EDT ARES on the right.

The EDT ARES arrived at the port of Palermo in the late afternoon of August 26th, 2005. During a preliminary meeting attended by its captain, the Phoenix engineer in charge and the representative of all authorities involved in the operation (Capitaneria di Porto di Palermo, Italian Navy, judicial authority, ANSV) the priorities, methods and procedures for the recovery were defined.

In specific terms, the following recovery priorities were agreed:

- Locating and recovery of any human remains from inside the wreckage and/or surrounding areas (three bodies were still missing);
- Recovery of the tail assembly, with the two flight recorders (FDR and CVR);
- Recovery of the other parts of the wreckage, including the front part of the fuselage and the cockpit.

In addition to the ship’s crew and the Phoenix personnel in charge of the recovery, the following personnel were also on board the EDT ARES:

- Three officers of the Italian Navy, coordinating all operations with the Magnaghi, which was stationed nearby to provide any technical or logistic support that may be needed;
- The Investigator-in-Charge (IIC) appointed by ANSV, who was joined in the following days

by other ANSV personnel, in charge of the technical coordination of operations and also of providing any technical help that Phoenix personnel might require in recognising the various parts of the wreckage;

- Personnel appointed by the judicial authority for the fulfilment of the operations within their area of competence.

All ROV launching, control and handling operations were performed by Phoenix specialised personnel, using special equipment located in a control room on the ship's deck.



Photo 46: Remora 6000 control room.

A survey room was also organized, fitted with suitable instrumentation, including three video displays, so that all activities and movements of the ROV could be followed through the images sent by the video cameras fitted on the ROV itself. A direct link was also established with the ROV control room for supplying any required information on the wreckage remains and on the correct identification of its parts.



Photo 47: The survey room.

The Launch And Recovery System was of the simple type (5x3 metres in size), made of an “A-frame”, powered by an HPU (Hydraulic Power Unit) and a pulley fitted with metre counter, for the umbilical cable the ROV was attached to.



Photo 48: The launching gear used for the Remora 6000.

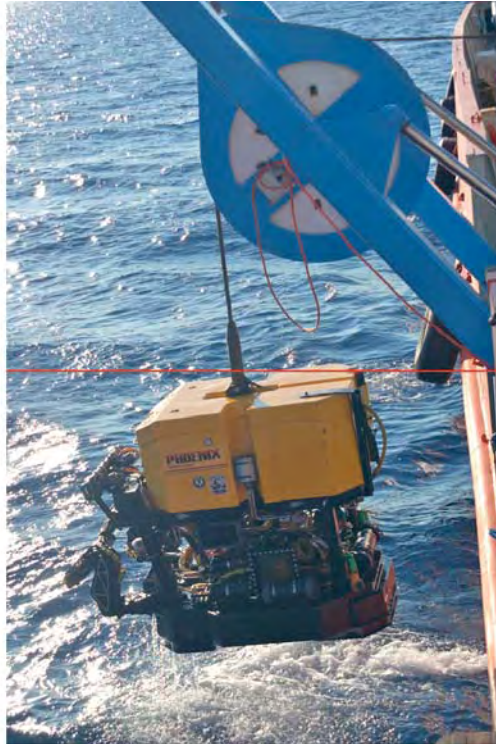

Photo 49: The launching gear with the Remora 6000 attached.

The system used for recovering the parts from the bottom of the sea was fitted with a Motion Compensation System. This device (photo 50) is used to compensate the movements of the sea during recovery operations, minimising any movement caused by the waves.



Photo 50: The motion compensation system.

As discussed in the previous paragraph, during the previous days the Italian Navy had carried out several search operations to locate the various parts of the wreckage that had sunk to the bottom of the sea. The seabed mapping data for the area and the coordinates of the probable position of some of the wreckage were communicated to the Phoenix representatives, who began their search at the points indicated by the Italian Navy.

1.15.1.3.2. Timing of the operations

On August 26th, 2005 at 21.55 local time the EDT ARES sailed from the port of Palermo heading towards the area of operation.

Below are some of the most significant activities in chronological order (the times in this paragraph are given in local time).

August 26th 2005

23.35: arrival at the operations area and start of the preliminary tests for the launching of the ROV.



Photo 51: The Remora 6000 on the launching system.

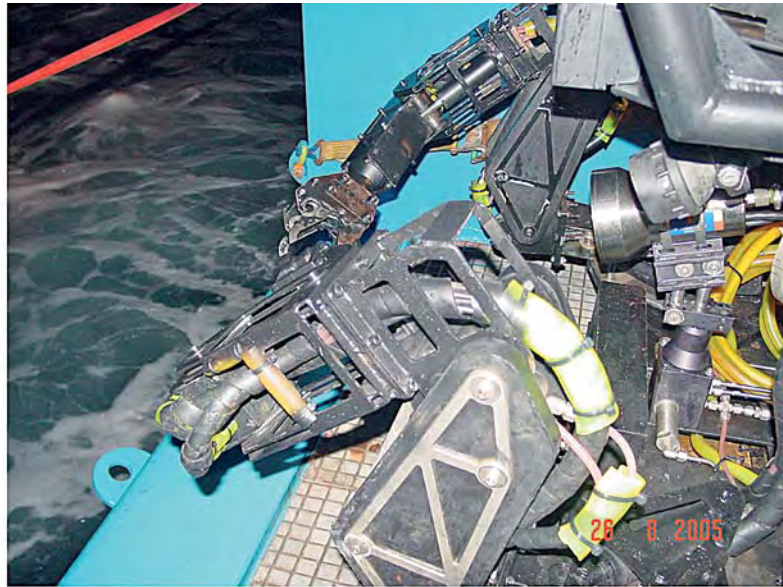

Photo 52: The Remora 6000, view of the mechanical arms.

August 27th 2005

02.00: start of recovery operations, operations briefing given by Phoenix personnel to the support personnel on board ship.

02.30: launching of the ROV and start of its descent to the bottom of the sea (1450 metres ca).

05.08: contact and visual inspection of some parts of the wreckage, particularly the tail assembly. The geographical coordinates were in accordance with those established by the Navy during the previous days. In order to check for any human remains, the inside was inspected. This operation was performed with difficulty (the roof of the cabin had collapsed). The results were negative.



Photo 53: The tail section at the bottom of the sea (approximate depth 1450 metres).

06.37: The front part of the fuselage, including the cockpit, was located. Its front section appeared crushed.

07.30: Visual inspection of a 100 x 100 metres square area around the previously located wreckage remains.

07.45: Human remains were found between the two main points indicated by the Navy, at coordinates 38°23.47 N - 013° 27.64 E.

16.15: Once the survey of the previously defined area was completed, the ROV was lifted back on board, so that the recovery of the human remains could be arranged.



Figure 19: Position of the ship in relation to the parts of the wreckage located.

The recovery operations started at 22.30 and ended at 06.30 on August 28th, 2005.

August 28th 2005

10.00: The ROV was prepared for the recovery of the tail section. Launch planned for 10.30 local time.

11.45: The operations for securing the ropes around the tail were started. They ended at 17.30.

19.05: After securing it with ropes, the tail section was lifted from the bottom of the sea using the winch installed on the ship.



Photo 54: Final stages of wreckage recovery.



Photo 55: Final stages of wreckage recovery.



Photo 56: Final stages of wreckage recovery.

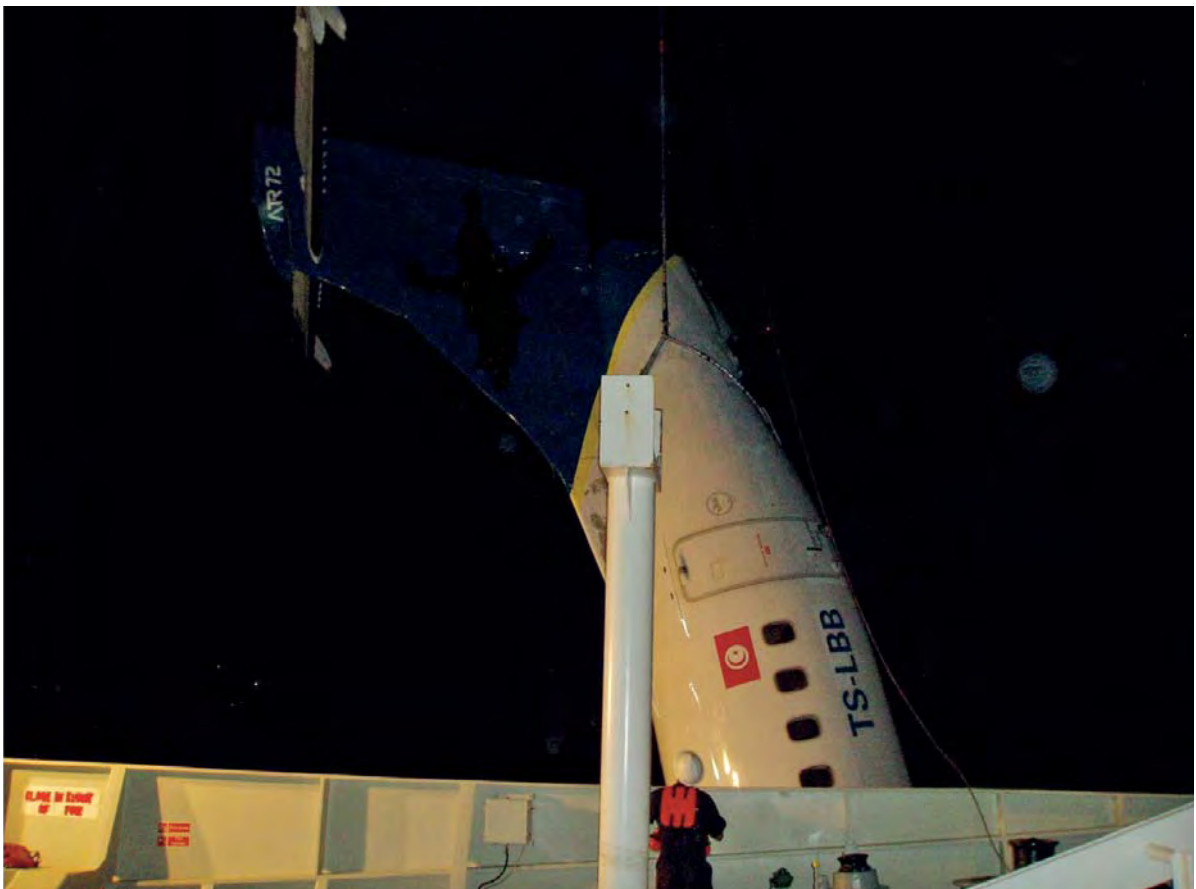

Photo 57: Final stages of wreckage recovery.



Photo 58: Positioning of the wreckage on the ship's deck



Photo 59: Front of the fuselage, nose landing gear.

22.00: the recovery of the tail section was completed. This was positioned on the deck of the ship. The rear section was immediately inspected from ANSV personnel, looking for the flight recorders. The CVR was in its position, but the FDR was missing. The FDR housing showed

some deformation, so, there was a strong possibility of the FDR still being at the bottom of the sea. The tail section was also searched with negative results.



Photo 60: The wreckage on the ship's deck.



Photo 61: The damaged FDR housing (note the deformation of the pressure bulkhead, demonstrating the strong impact sustained by the rear section of the aircraft).

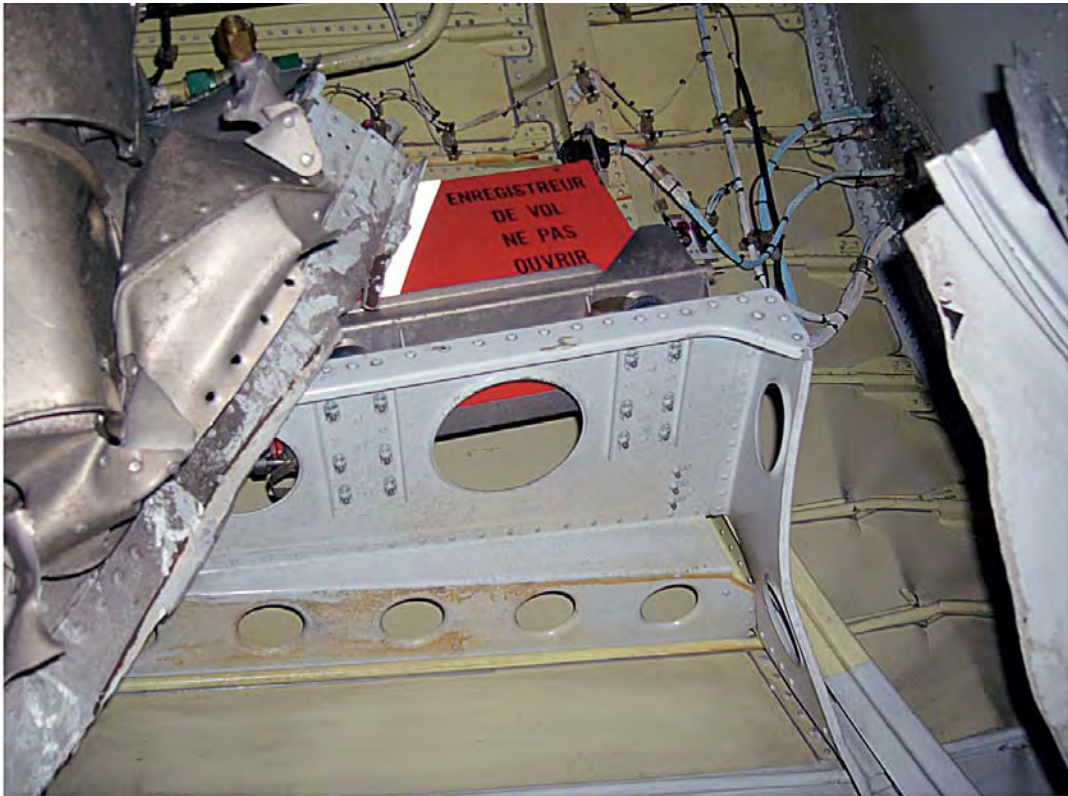

Photo 62: CVR in its housing.

Once the tail section was positioned on the ship's deck, with lifting gear still attached, the recovery personnel realised that a large part of the fuselage remains were still attached to the tail. In fact, the remaining part of the aircraft, including the front of the fuselage and the cockpit, was still attached to it. This meant that approximately 70 to 80% of the wreckage had now been recovered.

August 29th 2005

07.50: The Magnaghi kept on receiving emissions from the seabed with a frequency that could be traced back to the ULB of a FDR. The emissions appeared to be originating at geographical coordinates 38° 23' 42.82" N – 13° 27' 09.48" E. The EDT ARES therefore moved NW towards the point indicated and carried out with the ROV a visual inspection of the seabed.

08.15: numerous smaller parts sighted, which could be traced back to the aircraft wreckage, along the 300°/302° line from the point where the tail was found.

13.33: sighting of an object identified as remains of a human in position 38° 23' 40.48" N – 013° 27' 16.96" E.



Photo 63: Tail section on the ship's deck with front part of the fuselage

August 30th 2005

01:40: The research operations on the seabed continue and the FDR is sighted at geographical coordinates 38° 23.42 N - 013° 27.15 E. It appeared in good condition and was brought back to the surface using the ROV mechanical arms.



Photo 64: Recovery of the FDR by the ROV.



Photo 65: Recovery of the FDR.

07.40: together with the FDR, other objects were also recovered from the seabed. Also the FDR was immediately immersed in distilled water and then placed in the same container as the CVR, in order to prevent as much as possible any corrosion or degradation of the data magnetic tapes.



Photo 66: FDR (on the left) and CVR (on the right) immersed in distilled water for preservation and transport purposes.

Following days

During the following days the search for the last missing passenger continued and other parts of the aircraft were also recovered. This search gave positive results, with all the bodies of the passengers being found.

Figure 20 shows the position of the various parts of the wreckage in relation to the FDR and the bodies recovered.

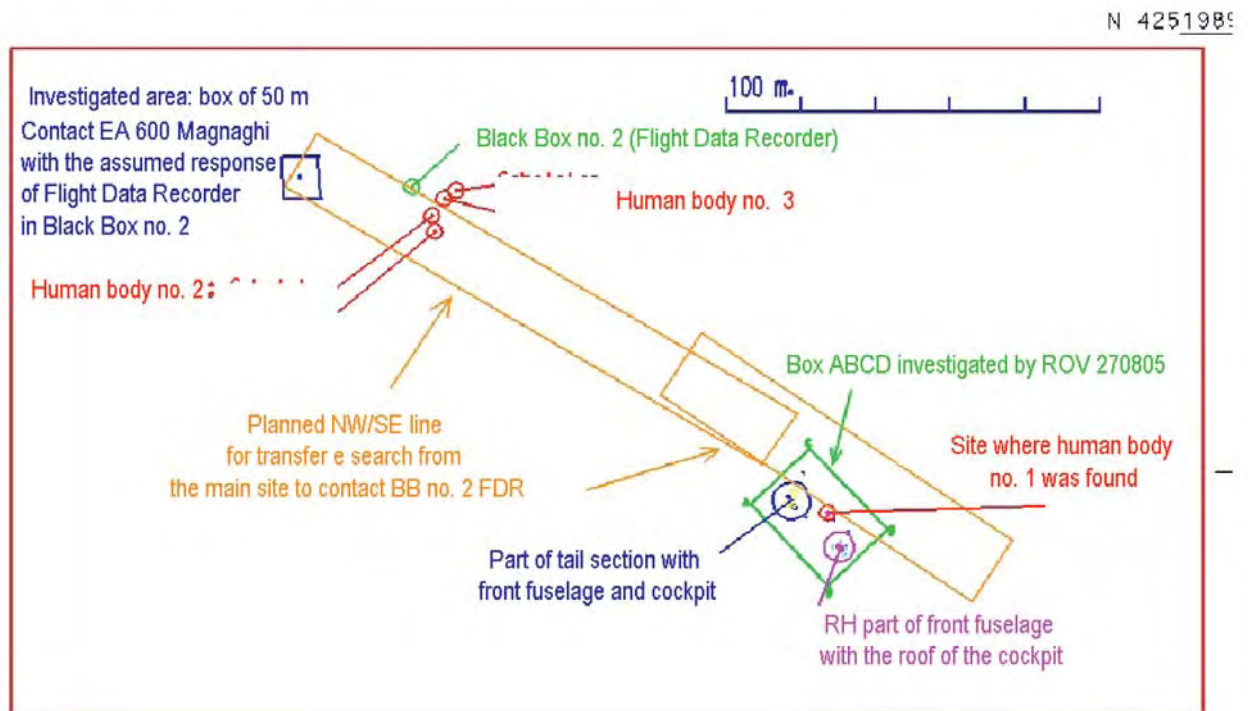

Figure 20: Position of the wreckage and parts recovered.

On August 31st, 2005, the EDT ARES returned temporarily to the port of Palermo to unload the parts of the wreckage recovered. On the same day the search operations for other parts of the wreckage restarted and the side panel of the front fuselage was also recovered.



Photo 67: Recovery of aircraft right-hand fuselage panel.

All recovery operations ended on September 2nd, 2005.

The wreckage and all its parts was subsequently transferred to a hangar inside Palermo's Bocca di Falco airport.

1.15.2. Search and rescue

1.15.2.1. Introduction

The Corps of the Capitanerie di Porto – Italian Coast Guard, is the Italian body in charge of search and rescue operations at sea.

With the issuing of d.P.R. no. 662, dated 28 September 1994 (*Regolamento di attuazione della legge 3 aprile 1989, n.147*), the regulatory presidential decree for the implementation at a national level of the 27 April 1979 Hamburg Convention, the General Headquarters of the

Capitaneria di Porto were given the function of IMRCC (Italian Maritime Rescue Coordination Centre), heading all those activities concerned with search and rescue of people lost at sea, utilising the resources of the aviation section of the Capitaneria di Porto, as well as any other form of support from military and civil rescue services, that may be deemed necessary. With this decree, sea rescue was no longer an activity to be carried out using the means available at that moment in time, but to be carried out using appropriate equipment and highly trained personnel. The IMRCC, which from a functional point of view can be included within the structure of the General Headquarters' Operating Unit, maintains contact with the coordination and rescue centres of the other countries, to ensure the type of international collaboration that is outlined in the above Hamburg Convention.

The above mentioned d.P.R. no. 662/1994 assigns the current 14 Maritime Centres the function of Maritime Rescue Sub Centre (MRSC), for the coordination of all maritime search and rescue operations within their own jurisdiction, to be carried out in accordance with the specific directives or delegations of the IMRCC.

Just for completeness, it is worth noting that the February 2006 edition of AIP Italy, part GEN 3.6, gives a detailed description of all the services carried out by the Capitaneria di Porto, in relation to sea rescue activities. It also includes the maps defining the geographical areas of responsibility of the various maritime rescue sub-centres.

In order to ensure full compliance with the appropriate regulations, the IMRCC has issued a "National Maritime S.A.R. Plan" (IMRCC/001), which was approved on November 25th 1996 by the Minister of Transport and Navigation (now Minister of Transport) in charge at the time. The document is basically divided into a preliminary section, dealing with the general and operating structure of the SAR Service, and a section containing the local plans of the 14 MRSC, including all available resources and any local operational connections.

The procedures of the said SAR plan are applicable to the search and rescue activities of people involved in accidents in the sea.

The moment that TS-LBB confirmed the emergency declaration (13.24 UTC), Palermo approach activated the alarm phase regarding an aircraft experiencing difficulties caused by technical fault, which was going to attempt an emergency landing at the Palermo airport.

The emergency measures outlined in the Emergency Plan that had come into force following order no. 02/03, issued by the Airport Authority of Palermo on January 27th, 2003 (“Standards and procedures for the support of aircraft in emergency situations and aid to aircraft in case of accidents”) were therefore put into action. The same Emergency Plan also states that in case of aviation accidents occurring at sea in an area within a distance of 5 nautical miles from the airport, the rescue operations must follow the Civil Protection Plan - Territorial Office of the Government of Palermo (July 2003 edition). The aim of this plan is in fact that of planning the rescue operations for an aircraft falling into the sea near to Palermo’s Punta Raisi airport (within 5 nautical miles radius). The operation procedures include the following three possibilities, which take into account any adverse meteorological conditions or the possible unavailability of aircraft or naval vessels:

- Operations using aircraft or naval vessels;
- Operations using naval vessels;
- Operations using aircraft.

All rescue traffic control until the end of the search and rescue operations was coordinated by the Capitaneria di Porto of Palermo.

In this particular case, having the aircraft ditched at a distance greater than 5 nautical miles from the coast of Palermo, the plan to enforce was the one relating to the already mentioned “National Maritime S.A.R. Plan” (IMRCC/001).

1.15.2.2. Initial actions

In consideration of the fact that the aircraft was in contact with Palermo APP, its position con particular reference to the ditching were basically known. The geographical coordinates given by Palermo airport traffic control to the flight captain of flight AP 2841 (41J), a B737 leaving Palermo and heading to Rome Fiumicino, and the only aircraft given authorization to take off at 14.00 UTC (16.00 local time), with the aim of quickly locate the wreckage were the following: 38° 24’29” N – 013°30’31” E. The B737 had in fact been ready well before 14.00 UTC, but the authorization was not given immediately because Palermo airport was undergoing the necessary emergency procedures required in the case of an aircraft requesting to make an emergency landing, as was the case for TS-LBB. The VVF (fire brigade) had already been informed and was ready in place to provide any aid needed to TS-LBB. According to the statement given by the B737 flight captain, he was listening to the same frequency used by TS-LBB to communicate

with Palermo APP (120.2 MHz), with the last intelligible communication taking place at approximately 13.35 UTC. He was therefore aware of the emergency situation and of the TS-LBB's intention to ditch (communicated via radio approximately 5 minutes before the actual ditching occurred). Therefore, once the authorization for taking off was received at 14.00 UTC, after approximately 8 minutes in the air he was able to sight the wreckage of the ATR 72 and confirm to Palermo control a position very close to the one received (radial 053° and 22 NM from Palermo "PRS" TVOR/DME). The B737 flew over the ditched aircraft at an altitude of approximately 1500 ft. The wreckage appeared intact on the water's surface, heading approximately 050°. There were no large vessels close to the aircraft. Due to the minimum altitude reached (1500 ft) and the amount of light reflected from the water surface, the B737 flight captain was unable to confirm the presence of any survivors and/or human shapes. The aircraft flew over the wreckage at approximately 16.06 local time, making a 360° degree left turn. Once the captain learned from the radio that a helicopter was close to the ditching area, he requested permission to leave and continue with his flight plan towards his destination (Rome Fiumicino).

He did however confirm the presence of two vessels, a fair distance from the wreckage. The first was a catamaran heading North, while the second was a large ship heading West.

Listening to the radio recordings on the frequencies used for the sea rescue, it was possible to ascertain that just before the actual ditching, Palermo control tower (Palermo TWR, "Raisi Tower") had informed the radio room of the Capitaneria di Porto Palermo (Compamare) that the aircraft was heading towards two boats ("*sta andando verso due barche*") and that it was 10 to 12 nautical miles north/northeast from Capo Gallo. Just over a minute later Palermo TWR was contacted on the same frequency by a sailing boat ("*Raisi Tower, this is sailing yacht PasseParTout, PasseParTout*") informing them that they were 12 miles from Capo Gallo and confirming their possibility to provide help ("*Can I help? Over.*") after learning that their distance from Capo Gallo was close to the one given from the control tower to Palermo Compamare and that there might be some problems ("*Is there any problem?*"). Palermo TWR informed the boat that an airplane was going to perform an emergency landing ("*we got an airplane performing an emergency landing over the sea*") and invited them to contact Compamare Palermo on channel 16 (marine VHF channel corresponding to frequency 156.800 MHz, normally used for rescue/emergency calls) for any instructions. After approximately 3 minutes, the sailing boat tried to contact (in English language) Compamare Palermo ("*This is*

sailing yacht PasseParTout, PasseParTout. Do you read? Over.”). Not receiving any answer, after approximately 2 minutes the boat tried to call Compamare Palermo again, this time in Italian “*Barca a vela PasseParTout*”. Again, no answer was received. No other calls made by the above mentioned sailing boat were recorded on this frequency. However it needs to be pointed out that radio communications on the marine channel were very disturbed. From the contacts with the skipper of the above sailing boat after the accident, it was confirmed that it was in fact a catamaran sailing from Formentera (Spain) to the isle of Vulcano (Italy), and which at the time was approximately 12 miles from Capo Gallo. While listening to channel 16, the skipper had realised that there was an emergency concerning an aircraft ditching in the area and wanted to confirm his ability to provide support. He contacted Compamare, as suggested by Palermo control tower. Not receiving any answer and aware that the rescue operations were already on the way, he then decided to continue on his sailing course. He also declared that he had not seen the aircraft or the ditching taking place.

It was not possible to correctly identify the other ship, which presence at sea was communicated by radio both by the TS-LBB before ditching and by the B737 flight captain during the reconnaissance carried out. It is however highly possible that the crew of the ship was not aware of the problem because, as it is already known, the ATR 72 performed the ditching with the engines shutdown and the propeller in the fully feathered position. Therefore there was not any of the typical noise which could have somehow drawn their attention.

The previously mentioned helicopter was the second aircraft reaching the location and coordinated all air operations in the area.

The helicopter was an AB-412, registration marks I-BRMA, based at Lampedusa and performing “118” (emergency response) service in the region of Sicily. At approximately 13.45 UTC the helicopter had taken off from Palermo Cervello Hospital, where it had previously landed to complete a helicopter rescue operation, and was on its way back to Lampedusa. When reaching Altofonte, the helicopter was informed by Palermo TWR of a ditching having occurred off the coast of Capo Gallo. Palermo TWR asked that the helicopter head towards the location of the ditching and start the rescue operations (approximately 13.59 UTC). The coordinates of the wreckage, as recorded by the I-BRMA upon reaching the destination, were 38° 23’ 35” N – 013° 27’ 01” E. I-BRMA arrived on location at 16.10 local time, 4 minutes after the

reconnaissance by the B737 had taken place. The helicopter was equipped to perform “118” service urgent transport and was therefore unable to rescue people from the sea using a winch. They were however able to assist the survivors as much as possible. At 16.36 local time they sighted a man in the sea without a life jacket and launched one of their own life belts, which the man was able to recover and use. According to the statement given by the helicopter captain, at 16.25 local time (46 minutes after ditching), the first patrol boat of the Capitaneria di Porto was able to perform the first rescue operations, by rescuing those passengers who had gathered on the wings of the aircraft. Four minutes later another patrol boat arrived and started to rescue people from the sea. The detailed sequence of the first rescue operations as reported by the captain of the I-BRMA helicopter, can be found in Attachment “G”.

1.15.2.3. Activities performed by the Capitaneria di Porto of Palermo

The 12° Maritime Rescue Sub Centre of Palermo Maritime Authority was the centre responsible for coordinating sea search and rescue operations in the area. The Sub Centre was informed of the emergency situation and the ditching of the ATR 72 aircraft both by the Rescue Coordination Centre of the Air Force Operations Headquarters (Comando Operativo delle Forze Aeree, COFA) of Poggio Renatico (FE), and by direct communication from Palermo TWR.

The Italian Air Force fulfilled their role by taking part to the search and rescue operations and by alerting the relevant Command and Control chain using the Radar Centre responsible for the area of operations. In particular, an HH-3F helicopter suitable for performing search and rescue operations was sent over by the 82° Search and Rescue (SAR) Centre, the centre-in-charge for the geographical area, based at Trapani Birgi military airport.

Below are highlighted the most significant search and rescue activities carried out by the Capitaneria di Porto of Palermo.

At 13.24 Palermo TWR informed the operating room of the 12° MRSC that an ATR 72 was going to perform an emergency landing at Punta Raisi airport due to technical problems. The intervention of patrol boats from Terrasini was immediately organised. One small unit returned to base due to adverse sea weather conditions. At the same time naval craft were also sent from the port of Palermo (moorings were cast at around 13.35).

Approximately 10 minutes after the first communication, Palermo TWR sent the communication that the aircraft would be unable to reach the airport and that it had ditched at approximately 12

NM from Capo Gallo. Therefore, the 12° MRSC immediately organised the intervention of further air and naval craft, among which:

- 7 patrol boats (M/V) of the Capitaneria di Porto (6 from the port of Palermo and one from Locamare Terrasini);
- 1 patrol boat from the Carabinieri, 3 from the Guardia di Finanza and one from the State Police;
- 1 patrol boat from the fire brigade from the port of Trapani;
- 2 private rubber dinghies with Locamare Terrasini personnel on board;
- 1 special water ambulance unit from the Red Cross Corps;
- 3 helicopters (A109 from the Carabinieri, AB-412 from the VVF, SH-3D from the Italian Navy, coming from Catania).

The “Giorgione” hydrofoil belonging to the company Siremar, sailing from Palermo to Ustica, was diverted to the area of the ditching, to provide any aid that may be needed.

At approximately 14.16 TWR communicated that an aircraft had reached the ditching area and that the TS-LBB aircraft was half submerged with some survivors having gathered on the wings.

At approximately 14.22, two boat patrols (CP 849 and CP 2205) were the first ones to reach the location of the ditching. The aircraft appeared with the LH and RH wings and part of the central fuselage floating (after remaining half submerged for a certain period, the front and tail sections had finally completely detached from the wings and sunk). Some passengers had been able to climb onto the wings. Various people, some alive and some dead, were still in the water with their life jackets on.

On the same day of the ditching a total of 23 survivors and 13 bodies were recovered. Three other people were missing from the aircraft. The search operations continued during the following days, but none of them were found. The three missing bodies were in fact recovered during the operations for the recovery of the wreckage, during the period between August 27th and September 2nd, 2005 (see paragraph 1.15.1.3.).

The LH and RH wings with the attached central fuselage section were secured and towed by CP patrol boats, with the support of the fire brigade, to the port of Palermo, where they arrived at 01.00 local time on August 7th, 2005.



Photo 68: Recovery of the LH and RH wings.

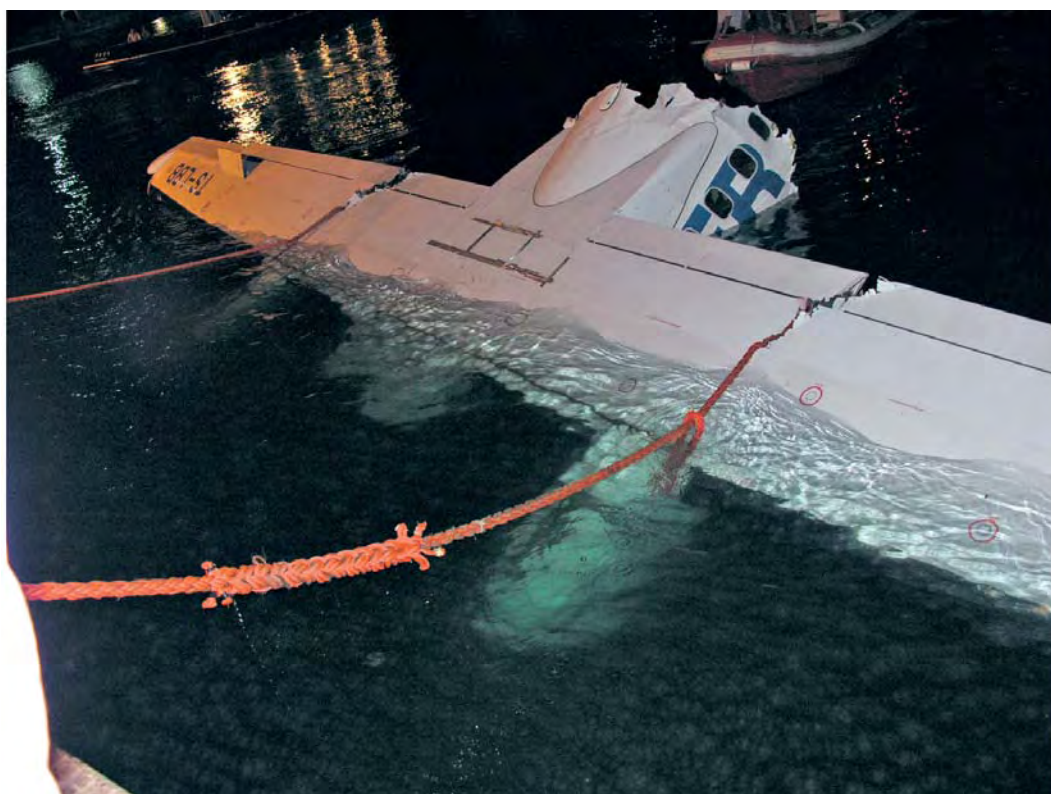

Photo 69: Recovery of the LH and RH wings, arrival at the port of Palermo.



Photo 70: Note the feather position of the right engine propeller.



Photo 71: LH and RH wings with part of the central fuselage and engines after recovery.



Photo 72: LH and RH wings and engines after recovery, the central fuselage section, front view.



Photo 73: LH and RH wings and engines after recovery, whole view.

1.15.3. Injuries suffered by the passengers and their positions on the aircraft

The diagram in figure 21 shows the position occupied by the passengers and crew members on board TS-LBB. Those who survived the accident are marked in green, while those who suffered fatal injuries are marked in red.

It is underlined that the aircraft tail section came away from the rest of the aircraft at row 13 and the break line also reached part of row 14. The passengers occupying seats 14A and 14C did in fact suffer fatal injuries, with serious head and chest injuries. The senior flight attendant, also in the rear section of the aircraft, suffered fatal injuries with lacerations and contusions on most of the body. He was recovered from the sea, still on his seat, which had completely detached from the cabin floor.

The other 10 passengers occupying rows 14 (D and F), 15, 16 and 18, all survived and suffered injuries which resulted in a few days of hospitalisation, compared to the other passengers occupying the front and central rows, who mostly suffered minor injuries.

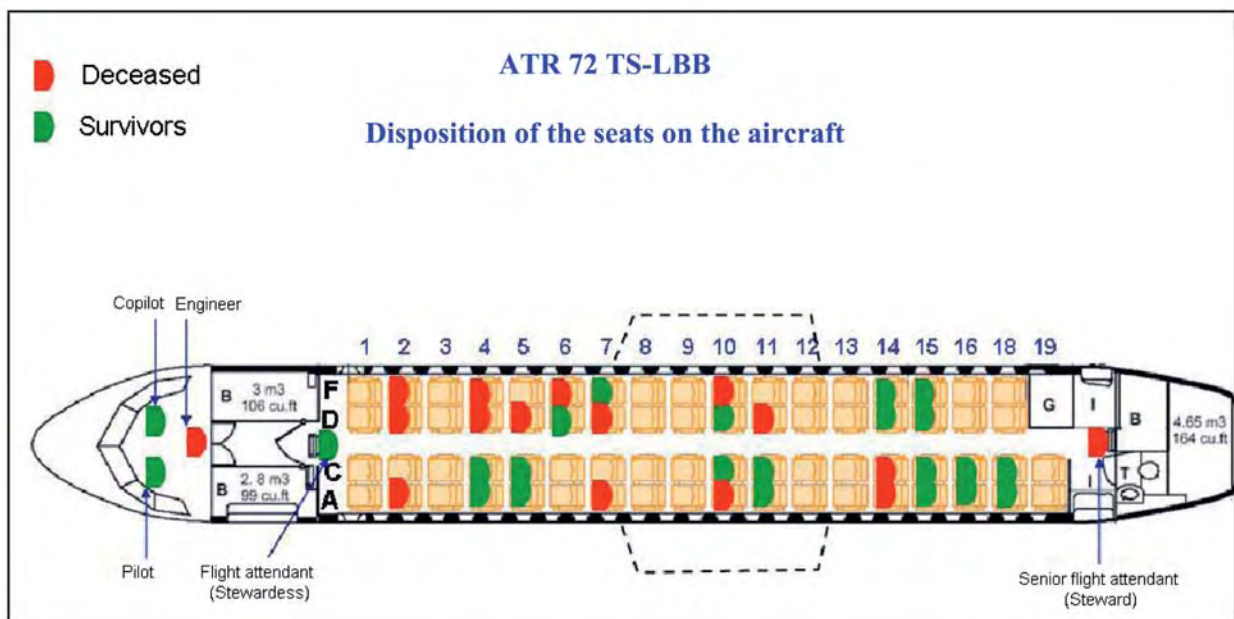

Figure 21: Disposition of the seats on the aircraft.

The traumatic lesions of passengers suffering fatal injuries consisted mainly in lacerations on most of the body. Those involving the senior attendant could be connected with contusive lesions caused by strong impact against hard parts of the aircraft.

Most of the passengers suffering fatal injuries were seated at the front right of the cabin and by the line where the break occurred. They suffered extremely serious facial-encephalic and chest-abdomen trauma, with various fractures to the lower limbs. In particular, some of them suffered shattering fractures of the spine-dorsal region, typical of very strong vertical stress. The other deceased passengers suffered cardiovascular arrest due to acute asphyxiation caused by drowning (8 out of the 13 bodies recovered on the same day of the event). These did also, as a whole, suffer serious traumas, which probably prevented them from any kind of movement.

As far as the three bodies recovered at the bottom of the sea during the recovery operations (see paragraph 1.15.1.), one of them was the engineer present in the cockpit at the moment of ditching. The other two were the passengers occupying seats on the right side of the aircraft. In their case, it was difficult to assess the cause of death with certainty.

1.16. TESTS AND RESEARCH

1.16.1. Introduction

From the beginning of the technical investigation, the wreckage, with all its parts, was put under judiciary sequestration. All tests carried out, including those on fuel samples collected from the wing fuel tanks, were completed by the competent judicial Authority. ANSV investigation personnel could only attend as observers some tests; such possibility was not always granted to the accredited representatives. The results were nevertheless made available. What follows is a detailed description of those tests and investigations carried out, which are considered of main interest in determining the cause and the factors that contributed to the accident.

1.16.2. Technical analysis of the wreckage, components and systems.

Chemical analysis of fuel/liquids

Samples of the fuel/liquid contained in the wing fuel tanks and in part in the engines, were collected on August 8th, 2005, after the central section of the fuselage, with engines and nacelles, was recovered. On August 10th, 2005 a sample of fuel was also collected from the tanker that had refuelled the aircraft at Bari before departure. The engine oil and fuel/liquid samples were sent to the laboratories of the Centro Sperimentale di Volo (CSV) of the Comando Logistico dell'Aeronautica Militare Italiana (Italian Air Force Logistic Command), for the completion of all necessary chemical-physical analysis.

The spectroscopic analysis, carried out to ascertain the presence of contaminants, produced negative results. No abnormal absorptions were in fact found, which could indicate contamination from other products. The results of the gas chromatographic analysis excluded any contamination from hydrocarbon products others than those expected. The values of the chemical-physical properties of the fuel samples were within the limits stated by the ASTM D 1655 standard, which defines, among others, the chemical-physical properties of A1 Jet grade aircraft fuel. In conclusion, the instrument analysis carried out on the fuel samples collected did not show any irregularities. This meant that any contamination from other substances could be excluded.

Recovery of PWC 124 engines' Electronic Engine Control (EEC) data

The two EECs (one for each engine, model EEC132-30), control the consistent flow of fuel to the engine, together with the Mechanical Fuel Control (MFC), and also record any faults that could be associated with the operation of the corresponding engine. It is however not possible to link any of the recorded faults with a defined time period. The recovery of the data recorded by the non volatile memories of the two EEC units was carried out at the manufacturer's premises, Hamilton Sundstrand (Connecticut - USA), during the days of September 19th and 20th, 2005. Even when not powered, these memories preserve the recordings of the codes relating to the failures which occurred starting from the date of the last maintenance carried out on the equipment.

It should be noted that the right engine EEC did not have the identification plate giving the P/N and S/N details. Whereas the relevant identification plate, with P/N 805813-1-005 and S/N 910805510, was present on the left engine EEC.

The engines had been in the water for a long time, and it was therefore not possible to accurately establish if the right engine EEC identification place was present before the event.

The collection of the data from the EECs' memories was carried out by the manufacturer's specialist personnel.

The information recovery operation gave positive results. This was also due to the good condition of the devices. The data recovered are in the form of a list of failure codes that have occurred from the date of the last reset, but they are not associated to a time parameter that could indicate when exactly they happened.

From the analysis of these data, it is possible to safely confirm that the engines did not suffer any notable failures, such as high turbine temperatures, compressor stall and/or malfunctioning of the internal components, which may have caused a spontaneous engine shutdown.



Photo 74: Engine EECs. Note the one on the left, for the right engine, without identification plate.

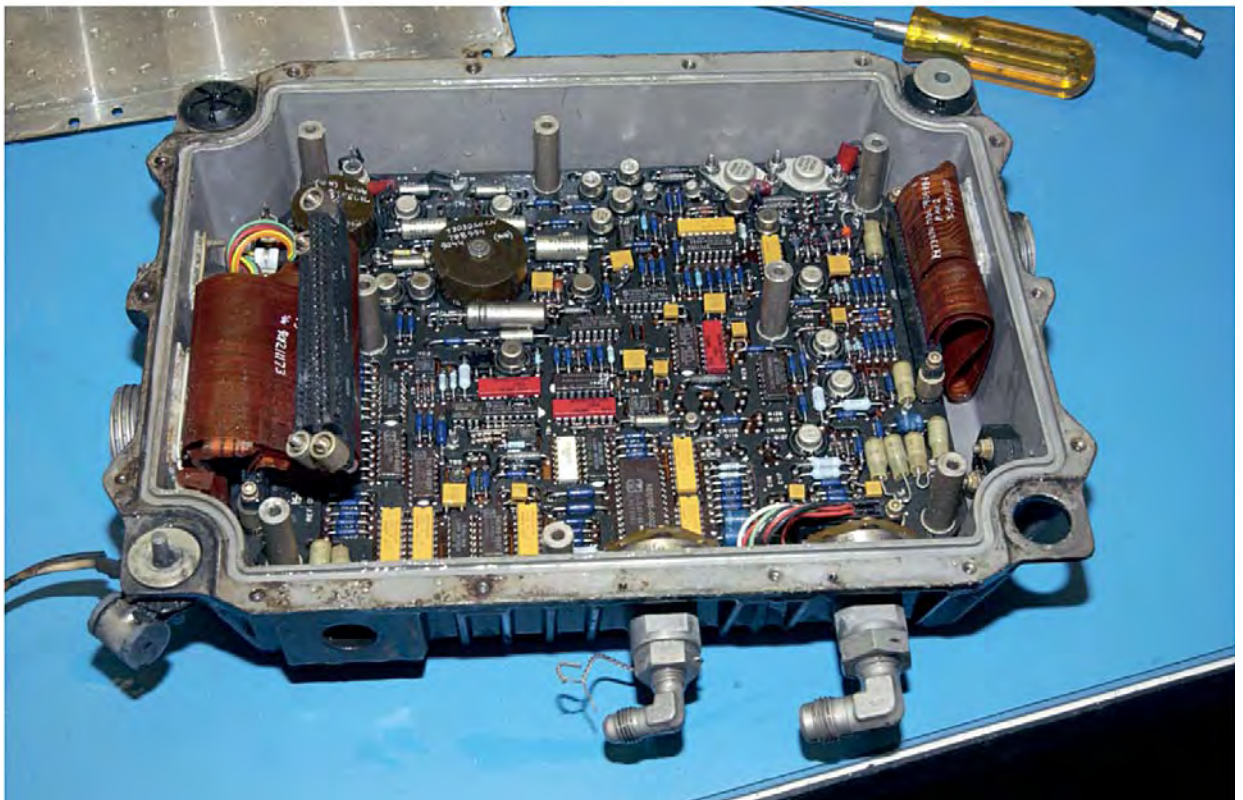

Photo 75: EEC internal circuits.

1.16.2.1. Engines assessment

After the impact against the sea surface, the engines and the propellers of the of the TS-LBB aircraft remained attached to the wings and did not sink. During the night between August the 6th and the 7th, 2005, the central section of the wreckage was towed to the port of Palermo and placed on the dry wharf. Following the instructions of ANSV personnel attending the operations, the wreckage was immediately rinsed with fresh water, in order to slow down the corrosion process.

As already stated previously in paragraph 1.12.3., the visual assessment performed on site showed:

- The substantial integrity of the propeller blades, which were only damaged during the recovery operations and placement on the wharf of Palermo harbor (bending);
- Pitch of the blades in the fully feathered position (the position of minimum drag to forward motion);
- No evidence of fuel or lubricants leaks;
- No evidence of damage to the feed lines.

The wreckage, including the engines, remained exposed to sea salt air and weather conditions, first on the port of Palermo and later at the Palermo Bocca di Falco airport, until September 28th, 2005, when the engines and the propellers were removed.

During the removal of the right hand propeller, a 4-metre long steel cable was found, wound around the engine shaft.

From October 17th to 21st, 2005, the engines were subjected to testing at an approved maintenance organization, with the aim of identifying any failure that might have caused the event¹⁶.

After completely disassembling the engines, all components were inspected and the configuration of both engines was checked (correspondence between the accessories and components actually installed and those listed in the technical-maintenance documentation).

During the disassembly operations, functional tests were also carried out on the injectors of the two engines. No anomalies were found.

¹⁶ An ANSV representative, as an observer, witnessed some of the engine disassembly operations, which were carried out under the supervision of the technical consultants of the competent judicial authority.

1.16.2.1.1. Results of the engine inspections

The inspections on all the components of the two engines did not highlight any failures or breaks that could be related to their shutdown in flight.

The degree of wear on the parts is in line with the hours of service, while the extended corrosion, particularly for the magnesium parts, can clearly be traced back to the exposure to sea water and sea salt air.

The metal chip detectors examined did not show any metal deposits, which indicates that the bearing, boxes and gears were all in good working order.

During the disassembly, some installation non conformities were detected, such as:

- Some of the connection devices (screws, bolts, washers and spacers) and gaskets used were different from that indicated in the drawings;
- The anchoring clamps for hydraulic tubes and electric cables were incorrectly fitted or did not have their plastic inserts.
- The connection devices were non sufficiently tightened.

The above non conformities did not cause any failure that could somehow be connected to the event.

1.16.3. Ground refuelling tests

In order to assess the functionality and the results of installing an ATR 42 type FQI on an ATR 72, ground refuelling tests have been carried out on an ATR 72 aircraft of the same type as the one experiencing the accident.

The tests were carried out at the Roma Fiumicino airport on September 5th, 2005, using an ATR 72 type FQI, already installed on the aircraft, with P/N 749-759 and S/N 0315, and an ATR 42 type, with P/N 748-465-5 and S/N 115.

The initial quantity of fuel in the aircraft was 600 kg, 300 kg per tank. The procedure consisted in assessing the quantity of fuel indicated by both FQIs, installed one at the time, with the increasing of fuel quantity, following the sequence below:

- Introduction of approximately 200 kg of fuel and reading of the FQI indications (see following photos);



Photo 76: Indication given by ATR 72 FQI fitted on an ATR 72 with 400+400 kg of fuel in each tank.



Photo 77: Indication given by an ATR 42 FQI fitted on an ATR 72 with 400+400 kg of fuel in each tank.

- Selection of a quantity of 3800 kg in total from the external panel, followed by automatic refuelling with the ATR 42 type FQI fitted and assessment of the quantity actually pumped into the tanks;



Photo 78: Indication given by an ATR 42 FQI fitted on an ATR 72 with a quantity of 3800 kg of fuel selected.

- Replacement of the FQI with one of the ATR 72 type, and assessment of the quantity indicated;



Photo 79: Indication given by the FQI ATR 72 on an ATR 72 with approximately 3800 kg selected (total actually present equals to approximately 1500 kg).

- Selection of a quantity of 2000 kg in total, from the external panel, followed by automatic refuelling with the ATR 72 type FQI fitted and assessment of the quantity actually pumped in the tanks;
- Replacement of the FQI with one of the ATR 42 type and assessment of the quantity indicated.

1.16.3.1. Results of the refuelling tests

The refuelling tests carried out in accordance with the above procedure enabled us to obtain 4 values for each type of FQI installed. In turn, these gave us the possibility of evaluating the effects on the fuel quantity indication. The results are shown in detail in the following graph.

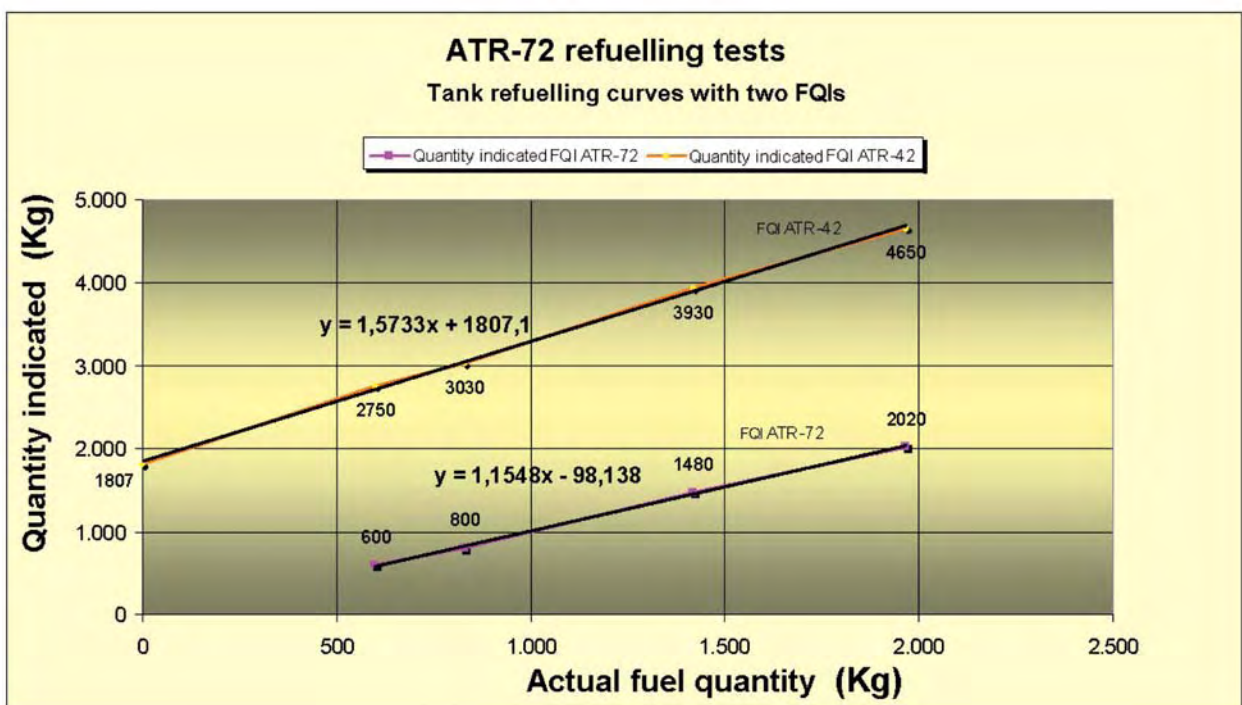

Figure 22: Tank refuelling experimental curves using two FQIs.

From the analysis of the results, it is therefore possible to state that the quantity indicated by an ATR 42 type FQI installed on an ATR 72 aircraft is higher than the quantity actually present in the fuel tanks and that it follows a linear variation curve, which is shown in the graph itself. In particular, by extrapolating the data based on the value of 0 kg, the indication of an ATR42 type FQI is equal to approximately 1800 kg. This is the quantity given by the TS-LBB crew to the air

traffic controller they were in communication with before ditching.

When the actual quantity of fuel in the aircraft is equal to zero, the ATR 42 instrument will indicate the presence of 900 kg in each tank (which means that the total quantity of fuel in the aircraft shown by the FQI is equal to or greater than 1800 kg). Therefore, the quantity indicated by the FQI of the TS-LBB aircraft before ditching was equal to 1800 kg (900 kg in each tank), meaning that the actual quantity of fuel present in the fuel tanks was equal to 0 kg.

1.16.4. Simulation of the search for a replacement FQI

During a visit to the technical-maintenance unit of the operator, a simulation of a search for an efficient FQI instrument was performed, using the information technology systems available to the line maintenance personnel.

The personnel in charge of checking the availability of spare parts use two video monitors located in the same room, at a short distance from one another. One of them is dedicated to the display of the Illustrated Part Catalogue (IPC), while the other is for the interrogation of the spare parts management system. After video consultation of the IPC, which had been correctly updated, the second video monitor was used to search for an FQI applicable to an ATR 72 aircraft. This was done by typing the three P/Ns indicated by the IPC (748-681-2, 749-160 and 749-759) in the search window of the ®AMASIS system.

As described in the user manual, the system responds by displaying the logistic information of the part identified with the P/N searched for, only if this is known by the system. Otherwise, the information relating to the item identified by the next alphanumeric P/N will be displayed. In accordance with this operating logic, when P/N 748-681-2 was inserted, the system responded by displaying P/N 748-722, the one immediately after, called INDICATOR FUEL REPEATER. On the other side, when both P/N 749-160 and 749-759 were inserted, P/N 749A00000-02 called CHAMBRE AIR PLENUM was displayed.

The same search was then performed by inserting P/N 748681-2, therefore omitting the dash between the first and second group of numbers. This is the P/N as printed (see photo 80) on FQI S/N 179, removed from the aircraft TS-LBB for replacement. In this case, the video monitor responded with the information relating to P/N 748681-2, called INDICATOR.



Photo 80: FQI S/N 179 nameplate (Data Plate).

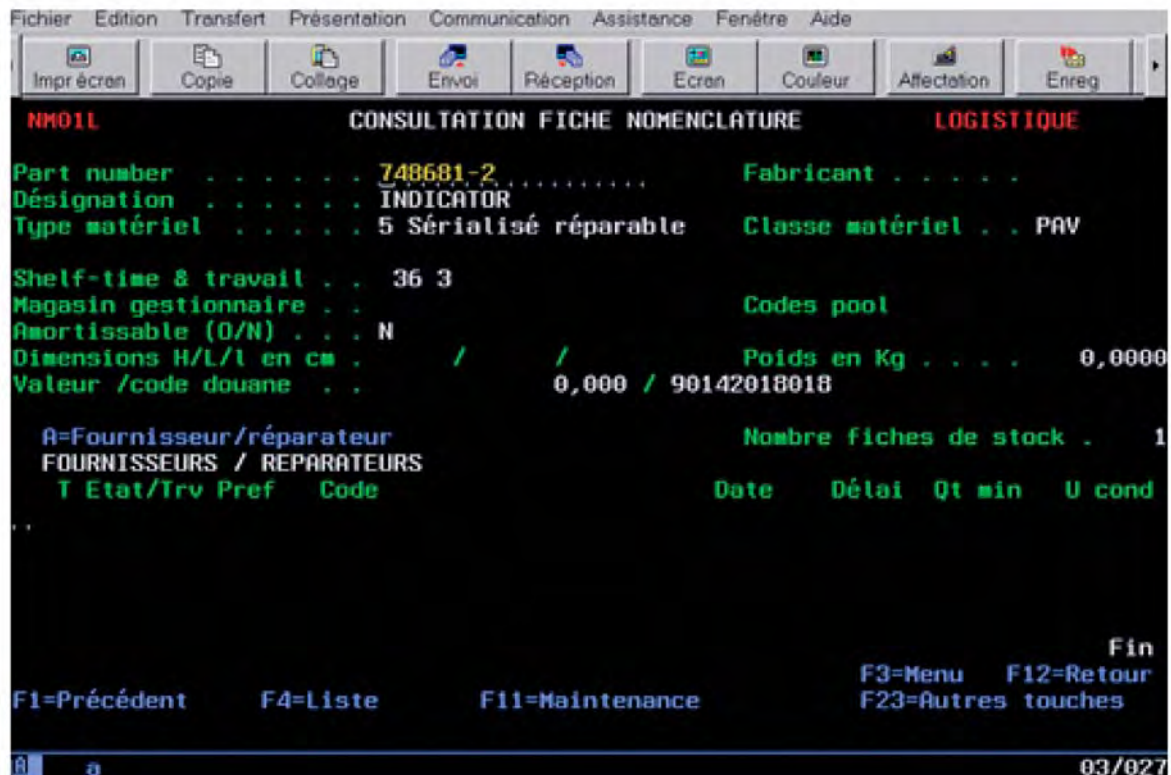

Photo 81: Information supplied for P/N 748681-2.

The tests carried out highlighted that:

- The P/N relating to FQIs applicable to the ATR 72 aircraft had not been entered in the operator's spare parts management system (®AMASIS) exactly as they appeared in the IPC, but according to the Certificate and Identification written in the JAA FORM ONE and the FQI Data Plate;
- The ®AMASIS system also recognises dashes between alphanumeric groups as significant characters.
- The P/N number stamped by the manufacturer Intertechnique on the S/N 179 FQI, is different from the one listed in the IPC for the ATR 72 aircraft, with the dash after the digits 748 being missing. P/N 748681-2 is also listed on the document called "Authorised release certificate – Airworthiness approval tag" (subsequently replaced by JAA FORM ONE, now EASA FORM ONE); the P/N of ATR's IPC reflects the Intertechnique certification P/N as determined by Intertechnique itself.
- The denomination of part P/N 748681-2 entered in the logistic system database is different from the one appearing in the IPC, but according to the Certificate and Identification written in the JAA FORM ONE (now EASA FORM ONE) and the FQI Data Plate".
- The denomination of the parts entered in the system database does not always correspond to the one shown on the IPC.

1.16.5. Aircraft performance check tests

In aircraft accident investigation practice, the performance of the aircraft involved is normally examined using *ad hoc* calculation programs (computer performance-based calculations), which have a quantifiable margin of error and whose results are validated by experimental flight tests and by the flight recorder data as well. Flight simulators, on the other hand, are normally used to check, analyse and assess the human factor aspects and those relating to resource management in the cockpit. The information contained in the flight recorders, and in the CVR in particular, is used in this process, for the purpose of ascertaining the action taken by the crew in the particular conditions of stress to which the failure to be handled gives rise.

Some of the algorithms used are also utilised for the simulation programs adopted in flight simulators, where, however, they are supplemented with other algorithms concerning the simulation of the aircraft's various systems and equipment. The margin of error and, therefore, the reliability of the results thus obtained from a simulator in terms of aircraft performance is not normally deemed representative of the real behaviour of the aircraft, especially in conditions

at the extremes of the cleared flight envelope.

Simulators are, indeed, optimised to simulate the behaviour of the aircraft and its systems in normal operating conditions and, as far as the simulation of failures is concerned, they are used, as stated above, to examine crew behaviour and operational failure management aspects.

They are thus designed for crew training requirements, and specifically for the abnormal and emergency situation or extreme operating condition management aspects.

An aircraft's performance cannot generally be completely faithfully determined or checked on a flight simulator.

1.16.5.1. ATR calculation programme

By using the data on aircraft status at the time when the first engine shut down¹⁷ and the distance estimated from the radar data (39° 13' 19" N – 013° 35' 46" E – approximately 66.64 NM from the threshold of Palermo runway 20) as input data, and by adopting a six-degree-of-freedom calculation code normally used by the manufacturer to ascertain and check the aerodynamic performance of the ATR 72, it proved possible to simulate the flight path adopted by the aircraft for the purpose of estimating the theoretical horizontal distance it could travel. It was, moreover, possible to estimate the effect of any greater drag created by the non-positioning of the engine propellers in the feather position after the engines themselves had shut down. The calculation code was validated in advance using the FDR data.

The simulations conducted took the following as initial parameters:

- Aircraft mass: 17.000 kg;
- CG (centre of gravity) = 25% MAC (mean aerodynamic chord);
- Temperature ISA (international standard atmosphere) +10 °C;
- Airspeed of maximum efficiency (optimum for gliding) after flame-out in second engine: 137 kts (for "fictitious" mass of 19.000 kg).

The model used the engine torque data recorded by the FDR and considered the propellers feathered (position of minimum drag to forward motion) after 60 seconds from the actual flame-out of each individual engine (NH = 0%). Commencing from the first engine failure, the calculation code established the horizontal distance travelled by the aircraft with and without the wind factor. Basically, it was demonstrated, solely from a strictly theoretical point of view, that had the procedures laid down in dual engine failure conditions, with particular reference to keeping up the speed of maximum efficiency, been applied, they would have enabled the aircraft

¹⁷ With regard to the V_{mHB} speed prescribed for maximum efficiency, the one matching the "fictitious" mass of 19.000 kg was selected: the real mass of aircraft + fuel mass (1800 kg - fuel quantity that the pilot thought he had on board).

to reach Palermo airport. Propeller rotation due to windmilling (rotation induced by the non-feathered position of the propellers) decreases the distance that can be travelled by approximately 25,4 NM.

1.16.5.2. Flight simulator tests

As will be better stated in paragraph 1.18.1. below regarding use of the data contained in the FDR and CVR by the ANSV, the ANSV was unable to divulge the information on the data recorded on said devices to the States accredited to participate in the technical investigation until the end of 2006. Consequently, only from that date, it was possible to conduct the simulator tests using said data, since it was feasible to share them with the accredited representatives and their advisers.

The tests were conducted on January 31st, 2007, on the ATR simulator in Toulouse (France) made available in response to the request made by the ANSV to its equivalent investigation authority in France (BEA), accredited as State of Manufacture to participate in the technical investigation, which contributed to taking care of the logistics and organizational aspects of the tests.

The purpose of the tests was to ascertain and assess the difficulties encountered by a flight crew in handling problems such as aircraft behaviour in terms of speed and attitude, communications with the air traffic authorities concerned and communications inside the cockpit and passenger cabin in conditions of dual engine failure and, consequently, electrical failure, as was the case on flight TUI 1153.

In particular, the data obtained from the flight recorders and the radar data were used to reproduce the flight commencing from flame-out in the first engine and extending to the moment when the aircraft came to a complete halt (impact with the ground/water or landing on Palermo Punta Raisi airport runway 20). The simulator session was preceded by a briefing setting out to provide the crews involved with detailed information on the goals and profile of the exercise and on details of the sequence of events.

During the failures, the crews were prompted to apply the procedures laid down in the manuals applicable to the TS-LBB. The time sequence in which the engine failures were applied was the same as the actual timing registered in the TS-LBB flight recorders.

Crews Used

Two simulations were conducted with different crews. The first was made up of two captains serving with an airline that uses ATR 42s and ATR 72s in its fleet, with considerable experience of flying the ATR 72, both check pilots and occupying the position of chief pilot and chief training officer, respectively; the other crew was made up of an ATR company captain and a captain serving with the operator of the aircraft involved in the event and with considerable experience of flying the type of aircraft concerned (he was also one of the adviser of the Tunisian accredited representative).

Main Flight Simulator features

ATR 72-200 FFS3 meets the requirements laid down in the applicable JAR (Joint Aviation Requirements)-STD 1A regulations and is certified for Level C. It is located at the ATR Training Centre in Blagnac (Toulouse – France). Registration marks: F-ATCS.

Certificate No.: F-106 issued by France’s DGAC (General Directorate for Civil Aviation) and valid until August 31st, 2008.

Initial status and initial preparation data for the simulator

The initial status in terms of geographical positioning of the aircraft was established from a comparative analysis of the radar data and the data obtained from the flight recorders. In particular, the geographical bearings of the point at which the engines failed are as follows¹⁸:

- Status 1 – RH engine failure:
39° 13’ 19” N; 013° 35’ 46” E.
- Status 2 – LH engine failure (100 seconds after the first failure):
39° 07’ 40” N; 013° 29’ 26” E.

The horizontal distances from the “PRS” TVOR/DME (terminal VHF omnidirectional radio range/distance measuring equipment) located at Palermo airport were, respectively, 67.5 NM for status 1 and 61 NM ca. for status 2.

TS-LBB’s speed, altitude and heading data were as set out in the following table.

¹⁸ The figures shown for the geographical bearings at which the engine problems occurred were calculated using the radar data collated against the FDR data.

Parameters	Status 1 – RH engine failure	Status 2 – LH engine failure (100 seconds after status 1)
Altitude (ft)	~ 23.000	21.500
Speed (kt)	182	177
Heading	221,5°	220,4°

Table 9: Initial Data Regarding Engine Failure Status.

Other pertinent data were as follows:

- Aircraft mass: 16.700 kg;
- Wind: direction 300°, speed 12 kts, constant throughout the descent;
- Centre of gravity (CG): 25% mean aerodynamic chord (MAC);
- Temperature: ISA+10 °C.

When performing the dual engine failure check list (“Double engine flame-out”), the VmHB corresponding to the mass of 19.000 kg, the “fictitious” mass, as it is called, meaning the one the crew thought it was carrying given the erroneous information provided by the fuel quantity indicator, was adopted.

1.16.5.2.1. Main findings

Simulation 1

Altitude (ft)	Speed (kt)	Distance from “PRS”(NM)	Notes
23.000	~ 194 ¹⁹	~ 67,5	Failure of first engine.
21.600	~ 188	~ 60.9	Failure of second engine.
18.000	~ 142	---	
15.000	~ 139	~ 41	
10.000	~141	~ 27	
8000	~138	~ 22	
6000	~ 142	~ 17	
4000	~ 138	~ 11	
2000	~ 141	~ 6	
~1000 (894)	~ 131	~ 3	
500	~	---	Landing on runway 20 at the speed of 106 kts – Altitude indicated with aircraft at standstill on the ground: 31.5 ft.
			Total time from failure of second engine 23 minutes and 15 seconds.

Table 10: Pertinent Data, Simulation 1.



Figure 23: Reproduction of flight made, Simulation 1, final part.

¹⁹ The speed of 194 kt is actually the one set by the simulator taking account of the altitude and temperature (ISA+10°) parameters input as initial conditions, whereas it emerges from the FDR data that the aircraft was flying at the indicated speed of 182.2 kt.

Simulation 2

Altitude (ft)	Speed (kt)	Distance from "PRS" (NM)	Notes
23.000	~ 171	~ 67,6	The wind direction initially set was 330°, then 300° from 14.000 ft.
21.800	~ 188	~ 61	Failure of second engine.
18.000	~145	~ 50	
15.000	~ 146	~ 41	
10.000	~ 148	~ 28	
8000	~ 137	~ 23	
6000	~128	~ 17	
4000	~ 129	~ 12	
1850	~ 132	~ 6	
978	~ 114	~ 3	
426	~ 109,6	---	
			Impact on the sea at approximately 1 NM from threshold of Palermo runway 20.
			Total time from failure of second engine 22 minutes and 37 seconds.

Table 11: Pertinent Data, Simulation 2.



Figure 24: Reproduction of flight made, Simulation 2, final part.

From the figures regarding the speed profile shown in Tables 10 and 11 above, it will be noted that said profile is more linear in Simulation 1 than in Simulation 2, despite the fact that in neither case the speed was always constant or equal to the V_{mHB} (optimum speed – optimum gliding speed) selected for the “fictitious” mass of 19.000 kg.

The crew that conducted Simulation 1 also reported during the debriefing that, although they had been able to land on runway 20, the decision to continue the approach when at 1000 ft, about 3 NM away from the TVOR/DME “PRS”, was not typical in operational terms. Pilots are not normally trained to land without flaps and without engines, so they had not been sure they could make a safe landing. In real conditions, without the certainty of being able to make a safe landing, they would very probably have opted to bring the aircraft down into the sea, where there is a better chance of limiting damage to aircraft and passengers than when making a forced landing on irregular ground, even in the awareness of having fuel on board, which may undoubtedly constitute a hazard factor in terms of passenger safety.

Considerations

The tests conducted proved that it was difficult to maintain an optimum speed profile, given the various interruptions that may arise in the handling of the failures that occurred. The procedures in use by the flight TUI 1153 operator were applied, and both crews handled the failures in substantially the same way. Maintaining the recommended speed (V_{mHB}) throughout the descent was considered something of a tall order, in view both of the difficulty of making correct use of the information from the available *stand-by* instruments and of the concrete difficulty of handling the various failures while keeping optimum control of the situation that had arisen. Indeed, during flight TUI 1153, the pilots were very anxious about the prospect of being unable to reach Palermo airport in safety. The particular situation that had come about, marked by both engines failing at an interval of approximately 100 seconds, gave rise to a situation of anxiety, doubt and uncertainty. Two engines failing simultaneously is, indeed, an extremely unlikely situation. The possibility of contaminated fuel being the cause of the engine failures would, moreover, not have been taken into consideration, as the flight had already lasted over 50 minutes with no problems whatsoever. The same applied to a shortage of fuel, as the FQI readings indicated that there were about 1800 kg on board. The problem on board was that not only had the engines failed, but the electrical generators, and hence the majority of the flight instruments, had consequently cut out as well. In particular, the distance from the Palermo “PRS” TVOR/DME was no longer shown on the flight instruments since the time when the

second engine shut down. Indeed, as soon as contact had been made with Palermo APP (approach control), the first question asked of the traffic controller in contact was the distance from the airport. The TS-LBB pilots asked the same question several times in the course of the emergency.

Table 12 summarizes main findings from the two simulations conducted.

Simulation	Total time	Time from failure of first engine	Time from failure of second engine	Notes
1	25 minutes and 33 seconds	~ 25 minutes	23 minutes and 15 seconds	Landing on runway 20.
2	~ 24 minutes	~ 24 minutes	22 minutes - 37 seconds	Impact on the sea at approximately 1 NM from threshold of Palermo runway 20.

Table 12: Main simulation findings.

1.17. ORGANIZATIONAL AND MANAGEMENT INFORMATION

The aircraft operator (Tuninter) was a company of Tunisian nationality belonging to the Tunisair group, founded in 1991 with, at the time, two ATR 72's and one ATR 42, and was flying domestic routes only. It subsequently, from 1996 to 2004, leased and operated two DC-9's and one B-737 for international charter flights. Since 2005, it has operated with one ATR 42 and two ATR 72's on domestic and international scheduled services and charter flights, the latter chiefly to and from Italy. The operator itself performs maintenance on its aircraft, with the exception of engines and engine components, under a licence issued by the Tunisian authority concerned.

The operator began in 1997 performing maintenance work on its aircraft, although it had previously been conducted by the group parent company, which continued to commission to conduct a number of specialised (paintwork, for example) and heavy maintenance jobs. The group parent company does not appear to possess a formal licence to perform maintenance operations on this type of aircraft (ATR 72).

Although over 80% of the company in question was owned by another Tunisian company, it was free to conduct its business autonomously, apart from using infrastructure, hangars, warehouses and personnel for the performance of technical operations.

According to the Maintenance Control Manual, the general manager of the company holds overall responsibility for aircraft maintenance, assisted by the technical manager.

The Technical Department (TD) is required to ensure that maintenance operations are performed on the aircraft operated by the company as scheduled and in accordance with the approved standards.

The home maintenance base is located at Tunis international airport; a number of subsidiary bases have also been put in place at the domestic airports most frequently served, whereas there are no technical support facilities at airports abroad.

At the time of the accident, the operator was using its own personnel to perform the following operations on its ATR42/72 aircraft:

- scheduled maintenance operations up to and including check C;
- non-scheduled corrective maintenance work.

There are three offices/services reporting to the TD: engineering, aircraft maintenance and procurement.

At the time of the accident, the TD staff was made up of approximately 45 members, 24 of whom belonged to the Maintenance service.

Quality Assurance

The Maintenance Monitoring Unit, which reported to the Maintenance service and had two inspectors on its staff, was responsible for conducting quality control on the work performed. A programme creating a technical and operational quality control system under the responsibility of the quality management (appointment of a quality manager, launch of training courses, etc.) had been set in motion in June 2005 but was still in the process of implementation at the time of the accident.

The audit programme was not yet up and running at the time of the event, as it had been sent to the Tunisian civil aviation authority for approval, and work on it began, however, in October 2005.

To all practical intents and purposes, prior to the incident, there was a quality control system based on inspectors, as provided for in ICAO Annex 6, which provides that there must in any case be an inspection system covering maintenance in place for basic maintenance in the absence of quality assurance control.

In 2006, in the wake of a technical, operational and management overhaul, the operator introduced a quality assurance function for the technical and operational aspects. It also began a training programme on human factor aspects for all personnel, whether technical, managerial and administrative.

Spare parts management

The spare parts are stored in the same warehouse used by the group parent company, in a distinct, clearly demarcated area inside it. The company uses the integrated information system known as ®AMASIS (acronym for Aircraft Maintenance and Spares Information System) as a logistics and maintenance management and control aid. The licence to use the ®AMASIS system belongs to the group parent company, which manages its software and hardware. Tuninter is a system user that has a number of terminals installed in the engineering offices, warehouses and hangar. For instance, the company uses the system to check aircraft configuration, manage spare parts and monitor the inspection schedules.

Spare parts are sought using the Part Number taken from the IPC (Illustrated Parts Catalogue] available in the vicinity of the dedicated ®AMASIS terminals.

It has been found that the Part Number fed into ®AMASIS for the FQI's is not always identical to the one shown in the IPC, as a hyphen is given after the first three alphanumeric characters in some cases, but not in others. The ®AMASIS system treats the hyphen as an alphanumeric character belonging to the Part Number.

In accordance with the Maintenance Control Manual, the Procurement service was responsible for spare part applicability and interchangeability data input and updating; the manual itself specifies that reference must always be made to the IPC when updating the data. The system records the dates on which amendments are made, but does not state their content or type.

Responsibility for part applicability and interchangeability data input and amendment was transferred to the Engineering Service a few months after the accident.

Other information

Nor does it appear that the operator had introduced a systematic flight data analysis system for preventive purposes (Flight Data Monitoring).

The airline operations manual²⁰ used by the operator (Manuel d'Exploitation – Généralités et Fondements, GEN-OPS) in force prior to the accident was the one covering a different airline, Tunisair, which owned over 80% of the share capital of the operator involved in the event. Tunisair had no ATR-42/-72 aircraft in its fleet. After the accident, on October 10th, 2005, the operator published a new GEN-OPS manual applicable to company operations and had it approved by Tunisia's DGAC.

²⁰ Annex 6 definition of Operations manual: a manual containing procedures, instructions and guidance for use by operational personnel in the execution of their duties.

Pertinent operating and maintenance procedures

Prior to the accident, the TS-LBB operator used two different logbooks for the operational and maintenance side, in which the flights (stretches) flown by the aircraft, the refuelling operations, the fuel consumption and the failures reported, along with the measures taken to remedy them had to be recorded. Both were parts of the CRM (Compte-Rendu Matériel de l'exploitant), which comprises a further logbook for the failure reported by the cabin crew.

In particular, one of the two separate logbooks, was labelled "Performance Record All Aircraft" in which it was recorded the flights flown, fuel consumption and refuelling operations, whereas the other - "Maintenance Log" - stated the failures reported and any maintenance operations performed to restore efficiency. The procedures in force at the time of the event did not prescribe to leave a copy of the logbook pages until the end of the aircraft's working day to the ground personnel. Indeed, there was no rule whereby a copy of the logbook pages had to be left on the ground prior to every flight. In the case in point in particular, only the "Maintenance Log" was found on board the wreckage, whereas the one recording the flights flown and consumption has been lost.

1.18. ADDITIONAL INFORMATION

1.18.1. Coordination between the judicial Authority's investigation and the ANSV technical investigation

As soon as it had been notified about the accident, ANSV, as provided in ICAO Annex 13 (provision 5.10) and in legislative decree 66 of February 25th, 1999, arranged the requisite coordination with the appropriate judicial authority to ensure the proper, prompt recovery of all the material required to ascertain the causes of the occurrence.

In particular, once coordination had been established, ANSV took it upon itself to liaise with the Prime Minister's office with a view to identifying the funds and technical facilities needed to ensure the recovery of the persons missing, the aircraft's flight recorders and its wreckage. It also liaised, coordinating constantly with the judicial authority concerned, with the Italian Navy to obtain the requisite support for the salvage operations, solely for the purposes of identifying and preserving the items salvaged.

ANSV subsequently filed the due applications for access to the documentation held by the judicial authority concerned, which it needed for the proper conduct of the technical investigation. Part of the documentation requested was made promptly available, whereas other

documents were not made available until ANSV had repeatedly pressed for them, and in any case long after the applications had been filed.

In connection with said dealings with the judicial authority concerned, emphasis must likewise be placed on the following aspects, which have featured in a complaint made to the judicial authority concerned as they were deemed penalising for the purposes of prevention and not in line with the provisions of Annex 13 of the Convention on International Civil Aviation, even though the judicial authority behavior was in accordance with the applicable Italian criminal law.

a) CVR and FDR Data Read-Out. The judicial authority concerned ruled on August 30th, 2005, that the flight recorders (FDR and CVR) of the aircraft, which had been sequestered, should be conveyed to the ANSV's headquarters and kept there pending further orders from the judicial authority itself. On September 10th, 2005, with the authorization of the judicial authority concerned and in the presence of the latter, its technical advisers, the parties and their respective advisers, the data contained in the CVR and FDR were extracted in the ANSV's laboratories. The data in question were transferred to appropriate data carriers, which were taken into sequestration, along with the tapes removed from the two aforementioned devices, by the judicial authority's technical advisers. ANSV was supplied with no copy of the CVR data in question immediately after the operation described above had been performed. A copy of the FDR raw data was, however, made available to ANSV for the subsequent decoding and analysis.

As per judicial authority decision, only a few days later was ANSV also granted access to the CVR, albeit without being able to pass them on (FDR and CVR data), as provided in Annex 13 of the Convention on International Civil Aviation, to the foreign accredited representatives entitled to view them.

ANSV was still complaining to the judicial authority concerned on September 5th, 2006, (i.e. almost a year after the extraction of the CVR and FDR data) that it was unable, owing to the restrictions imposed by the judicial authority, to pass the aforementioned data on to the foreign accredited representatives entitled to view them, as provided by the international regulations on the subject. It was also made clear on the same date that said restrictions were also precluding ANSV from conducting the simulations needed for the purposes of the technical investigation, given that it was unable to share the data in question with other parties. Not until November 9th, 2006, did the judicial authority concerned authorize ANSV to make unconditional use of the CVR and FDR data for the purposes of the investigation and to make them available to the foreign accredited representatives entitled to view them.

b) *Rights of the Foreign States accredited to participate in the investigation.* Some rights granted to the foreign states accredited to participate in the investigation by Annex 13 to the Convention on International Civil Aviation were limited by the judicial authority under the criminal proceedings system currently in force, particularly in terms of speedy access to information of prime importance to prevention.

Albeit not strictly connected to the dealings between ANSV and the judicial authority concerned, it seems appropriate to state in this report that, under the system currently in force (criminal law procedures), the judicial authority made the content of the CVR from the aircraft available to the parties involved in the criminal proceeding in January 2007. On the afternoon of the same day on which the parties had been granted access to said content, a number of news media, it is not known how, gained possession of it, making it public both in print and in the voice media. Some of the conversations recorded by the CVR in question and made public were irrelevant in terms of piecing the sequence of events back together.

1.18.2. Company procedures for fuel management

In the operator's technical operations documentation and precisely in the operating manual, in paragraph 8.3.7 (Policy and procedures for in-flight fuel management), there are the established and detailed flight crew procedures for correct fuel management. In particular, it is provided for that the flight captain (CDB) is to ensure that fuel checks are carried out at regular intervals, at least every 30 minutes in flight. At each check, the quantity of fuel remaining on board is to be then recorded, in order to verify that the true quantity consumed corresponds to that foreseen and that it is sufficient to reach the planned destination. The same operational documentation includes, in addition, the procedure to be followed for calculating the amount of fuel necessary to complete that leg of the flight.

1.18.3. Ditching

For all aircraft not classified as seaplanes or amphibians, ditching is regarded as an emergency manoeuvre, and the procedures laid down normally refer to conditions in which the aircraft is controllable, with its engines running until the time of impact with the water surface. Generally speaking, it is always preferable for speed to be as low as aircraft configuration and levelled wings permit. The parameters that have to be taken into consideration for a ditching as safely as possible are: wind direction and speed; the type of swell; mass, attitude and the aircraft's vertical and forward speed.

In ideal conditions, an aircraft should be ditched into the wind, as this makes for the lowest speed relative to the water, and hence a lower degree of impact damage to the structure.

When the swell is particularly strong, it is preferable to land with a flight path parallel to that of the main wave (see Figure 26 in the next paragraph 1.18.4.3.), even with a cross-wind and at higher speeds.

Ditching with a trajectory perpendicular to the swell might be hazardous, as the forepart of the aircraft might be submerged, thus giving rise to considerable structural strain.

Emergency ditching with conventional aircraft is a subject little covered in pilots' training courses. Pilots are not normally trained to fly over sea waves at low altitude. In case of ditching it is crucial to be capable of determining wind and wave direction and speed. The best method is to observe the ruffling and foam crests, if any, on the water surface. Ruffling due to the wind appears as trails of bubbles or foam and moves upwind and downwind. The foam of the crests falls forward, following the wind, but is soon overtaken by the wave that falls on its base. This may give the impression that the foam is moving backwards, tricking the pilot into thinking that the wind is from the opposite direction. The most difficult part of the manoeuvre is estimating altitude above the water. A close estimate may be made, but there is never any way of knowing precisely when the surface will be touched. An attitude with the nose as far up as possible, considering aircraft configuration, must be maintained at the moment of contact. The ideal pitch angle for the ATR 42 and ATR 72 is 9°.

In summary, the most important parameters which must be taken into consideration for a ditching are:

- Ditch parallel to the waves;
- Low vertical speed (low rate of descent);
- Deck angle of 9°, optimum value for ATR 42 and ATR 72;
- Low longitudinal (forward) speed;

When ditching the pressure of the water on the fuselage depends upon the vertical speed at the time of impact with the water. When the vertical speed is considerable and the impact takes place with the rearmost part of the fuselage, the aircraft receives a pitch down moment that forces the nose into the water. This effect is worsened by the perpendicular impact with the waves.

As far as the ditching of TS-LBB is concerned, it must be emphasised that the swell conditions and the wind direction were not easy for the crew to establish.

Photo 82, taken about 40-45 minutes after the aircraft ditched from the rescue helicopter that was the first to arrive on the scene, shows that the conditions at sea did not make it possible to distinguish the swell direction for certain at low altitude (approximately 500-1000 ft).



Photo 82: The TS-LBB wreckage shortly after ditching.

1.18.4. Pertinent ATR-72 Non-Standard (Procedures following failure) and Emergency Procedures

A number of the non-standard (Procedures following failure) and emergency procedures set out in the Flight Crew Operating Manual (FCOM) published by the ATR manufacturer are cited below. The FCOM states the ATR 72's main features in terms of system and performance description and the procedures to be adopted when operating the aircraft. The FCOM is a complementary publication to the ATR 72's flight manual (Airplane Flight Manual – AFM), approved, in accordance with the reference regulations, by the certification authority. The Quick Reference Handbook (QRH), which summarizes, in a form handy for the crew to consult, the applicable normal and emergency procedures as referred to the aircraft, also forms part of the reference documentation for operating the aircraft.

With regard to task sharing among the flight crew when applying the emergency procedures,

page 2.04.01 of the FCOM reads as follows.

The pilot flying (PF) remains such throughout the performance of the emergency procedure and is, in particular, responsible for handling engine power (Power Levers -PL) and steering the aircraft, whereas the pilot not flying (PNF) has to read and carry out the items on the check list, operate any controls on the OVHD (overhead) panel and the condition levers (CL), and handle radio communications with the traffic control authorities in contact.

In the case in point, the captain was the PF and the first officer was acting as PNF.

1.18.4.1. Engine flame out and Single engine operation

The procedure to be applied varies according to the flight phase in which the failure occurs and the type of failure in question. The FCOM states that a flame out in one engine may be recognised by a rapid drop in ITT (inter-turbine temperature) and engine speed NH (high-pressure compressor speed).

If the occurrence takes place during takeoff, the procedure is to be considered an emergency procedure and is cited as “Engine Flame Out at Take Off ” (see Attachment “B”).

If, on the other hand, the occurrence takes place at other stages in a flight, the procedure is considered non-standard (FCOM Part 2.05.02, page 10 – “*Procedures following failure*”) and is cited as “*Engine Flame Out*” (Attachment “B”). It is also stated on the same page that the causes of engine flame-out may normally be divided into two following categories:

- External causes, such as icing, severe turbulence or incorrect management of the fuel on board. These types of cause may be easily diagnosed and immediate re-ignition may be attempted. Indeed, the procedure prescribes feeding the engine igniters as the first step (this aspect will be discussed in greater detail in the next paragraph);
- Causes inside the engine, such as stalling or failures stemming from individual engine components. These, generally speaking, cannot be easily diagnosed, so the procedure is to shut the engine down completely and attempt to find out what sort of failure has arisen by other methods.

FCOM page 2.05.02-P1 also states the procedure to be carried out, at stages other than takeoff, after encountering a failure that entails or causes an engine flame out (“*Single Engine Operation*,” repeated on page 2.04 of the QRH). Such procedure prescribes to land at the nearest airport, giving the efficient engine maximum continuous thrust (MCT) and isolating the systems running off the failed engine. It is emphasised on page 2.05.01, in connection with the

chapter introducing the procedures to be carried out following failures (“*Procedures following failures*”), that prior to carrying out the prescribed procedure, the crew must appraise the particular situation as a whole, considering any restrictions on its application. Such procedures must thus be carried out after the failure has been diagnosed by the crew, which must then appraise any restrictions in the light of the particular operating situation.

Chapter 3.09 of the FCOM lists all the performance data of the aircraft with one engine failed and the procedures to be applied in terms of flight parameters to be adopted, considering the obstacles to be avoided along the route.

1.18.4.2. Both engines flame out

The emergency procedure concerned is set out in the FCOM on page 2.04.02-P3 and repeated on page 1.03 of the QRH (see Attachment “B”). Two “*memory items*” steps that must be taken immediately, without waiting to read the check list in detail, are laid down. In particular, the “*memory items*” prescribe positioning the rotary ENG START selector on CONT RELIGHT (continuous relight, the engine igniters are relit) and the PL on FI (Flight Idle), in order to prepare the system at once for a restart. If this does not happen and the engine speed (NH) decreases by more than 30%, the CL must be placed on SO (Shut Off) to halt the flow of fuel into the engine combustion chambers and allow any fuel that has accumulated inside them to be drained off.

After checking that the fuel system is working correctly (there is fuel in the tanks and the feed pressure is normal), the procedure entails reducing speed to V_{mHB} (which is 1.23 V_S in flaps 0° configuration, known as drift down speed²¹, the optimum descent or gliding speed), so as to optimise the ratio between altitude and distance that can be traveled and attempt to restart the engines, commencing with the RH engine (No. 2).

It is important to highlight the fact that, in order to re-ignite the RH engine (ENG 2) after achieving optimum gliding speed, the ENG START selector must be switched from CONT RELIGHT (where it was positioned beforehand under the memory items) to START A & B and the ENG START push button (ENG START pb) pressed. In no other way is it possible to start the ignition sequence, which may be controlled by monitoring the turbine and high - and low - pressure (NH/NL) compressor speed instrument and the engine T6 temperature (ITT, temperature between the high-pressure turbine and the free turbine that drives the propeller). On reaching 10% of NH, the CL of the engine concerned must be positioned on FTR (feather, propeller feathered).

²¹ Optimum descent speed (drift down speed), at which the ratio between the aerodynamic lift and drag produced by an aircraft in flight, known as aerodynamic efficiency, peaks. Said speed is matched by an aircraft attitude with which the maximum horizontal distance is travelled at a given altitude.

In the event of the procedure having a positive outcome for at least one of the two engines, the flight must continue in accordance with the “Single Engine Operation” procedure. Otherwise, the forced landing or ditching procedure controls must be applied.

1.18.4.3. Ditching procedure for the ATR 72

The ditching procedure is set out in the aircraft’s technical and operating documentation (Attachment “B”, FCOM page 2.04.05-P2 and QRH page 1.08) and refers to general system operating conditions, and some measures may have no effect, according to the particular failures that have arisen. Indeed, the procedure does not specify the causes necessitating ditching, but lists the measures to be taken by the flight and cabin crew, according to the time available, to limit the damage stemming from the impact with the sea and to prepare the passengers to adopt the correct position on board with a view to minimising any injuries.

The main operations that the flight crew has to perform, pursuant to the aforementioned publications, are highlighted below:

- Informing the flight attendants of the emergency situation and ordering them to implement the ditching procedure;
- Apprising said attendants of the specific time left for ditching;
- Reporting the emergency situation to the ATC (air traffic control) authority with which they are in contact;
- Squawk code 7700 onto the transponder (unless another code has been previously requested by the ATC authority);
- Preparing the aircraft configuration, with, in particular: GPWS (Ground Proximity Warning System) on OFF and Signs ON, and pressurisation control (Mode Sel. on AUTO and Land. Elev. on 0);
- Securing any loose objects that might constitute a hazard on impact.

The passenger cabin crew must perform the following operations in particular:

- Inform the passengers that there is an emergency and instruct them in the operations to be performed in order to attempt the forced ditching in safety;
- Point out the emergency exits;
- Stow or secure all loose objects.

The following measures are prescribed during the approach to ditching:

- DUMP on ON, if there is still a pressure differential (aircraft still pressurised): this brings the cabin differential to 0 and thus depressurises the aircraft;

- PACKS on OFF: this shuts off the pressurisation air outlet;
- OVBD (overboard) valve on CLOSE: this shuts off the avionics compartment cooling air exhaust valve;
- FLAPS at 30° (if available): this makes it possible to reduce the ditching speed (a note is given highlighting the fact that the flaps cannot be extended if electric power is supplied by the batteries alone);
- LANDING GEAR UP (landing gear in the retracted position);
- DITCH pb (push button) ON (30 seconds prior to impact or at an altitude of 1250 ft): the outflow valves are closed to prevent water from entering the aircraft;
- ENG START on OFF/ABORT START (the engine starter system is cut out);
- CABIN REPORT: assurance given by the cabin crew (normally the senior flight attendant) that the cabin has been prepared for ditching.

In the phase immediately preceding ditching, and in particular at an altitude of 200 ft (about 61 metres), it is necessary to:

- Adopt an attitude of 9°, which is considered the optimum;
- Minimise the inclination of impact (reduce the vertical descent speed as far as possible);
- Order the flight attendants and passengers to adopt the safety position (BRACE FOR IMPACT);
- Shut down the engines and close the fuel throttles; in particular: propellers feathered and engines shut down by closing the fuel throttle and associated pumps (CL *both* FTR then FUEL SO, FIRE HANDLES: PULL; FUEL PUMPS: OFF).

Once the aircraft has been ditched, the evacuation order must be given. It should be noted that, for aircraft balance reasons, at least one of the two rear exit hatches will be below the water line, so a warning is given against opening it.

In particular, as stated in the FCOM, it is very important to assess wind and swell direction and the state of the sea in the final phase of the approach if the manoeuvre is to be successful and damage is to be minimised. If the sea is flat calm, ditching into the wind is recommended, thus further reducing the speed on impact, whereas if there is a swell, ditching in parallel with the waves is recommended (see Figure 26), even if this means settling for a measure of crosswind (in the case of the ATR 72, a measure that does not call for a correction of drift greater than 10°). It is also necessary to keep the wings as level as possible, preventing one wing tip from touching the water before the other. Otherwise a yaw would be created, with disastrous results for the aircraft's structure.

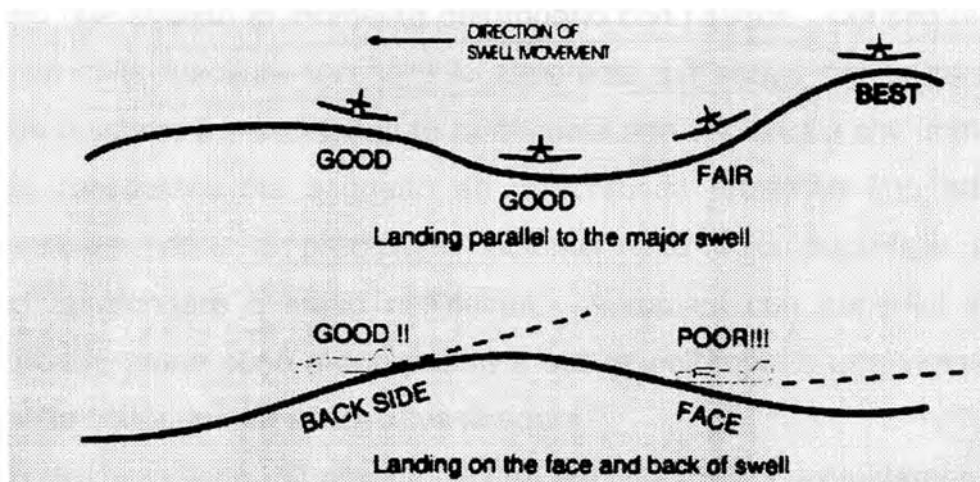

Figure 25: Example of ditching according to swell direction.

If there is a strong wind that entails a wide drift (for the ATR 72 $> 10^\circ$), the ATR 72 FCOM recommends ditching into the wind so as to take advantage of the major reduction in speed. In such cases, the aircraft must touch down on the back of the wave (Figure 25) to limit the effect of impact. Ditching in the opposite direction to the swell must be avoided in all cases, always provided the major swell direction can be distinguished in the final stage of ditching. Ditching in the same direction as the waves might, after the initial impact, which normally occurs with the rear part of the fuselage, give rise to a situation in which the forepart of the aircraft is submerged by the waves, jeopardising the aircraft's structural resistance.

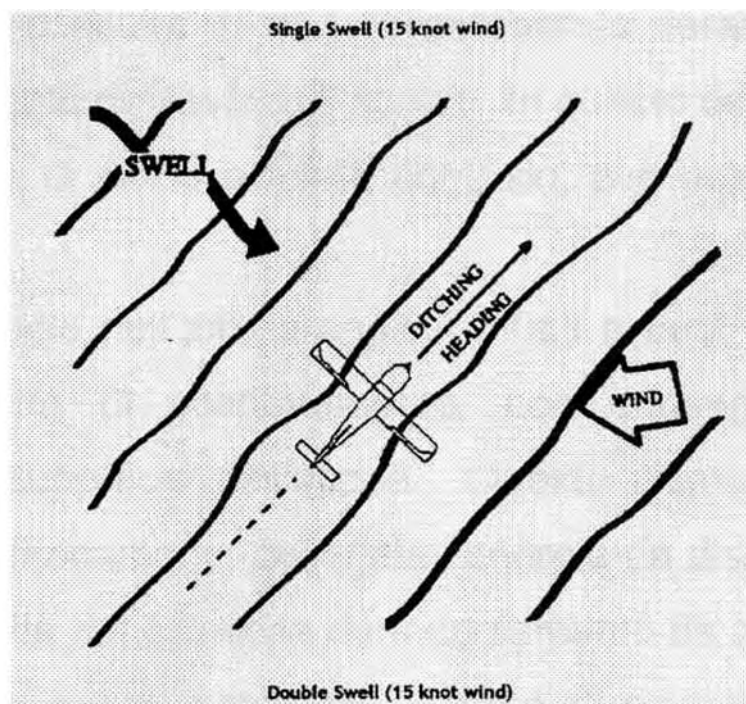

Figure 26: Example of heading recommended for ditching with respect to the swell.

1.18.5. Aeronautical technical personnel qualification

The issuance and renewal of licences and qualifications of the personnel permitted to perform aeronautical technical work in the Tunisian civil aviation sector is governed by a Tunisian Ministry of Transport and Communications decree dated 24 November 1975.

Pursuant to said decree, licences may be issued for:

- Aeronautical technicians specialising in airframes and engine systems;
- Aeronautical technicians specialising in avionics (defined in the same decree as the full set of mechanical, electrical and electronic instruments and apparatus mounted on board aircraft).

The qualification specifies the type of aircraft and equipment on which the licence holder may work and the degree of technical complexity of the operation, categorised as follows:

- Category A (inspections and major repairs, overhauls and modifications);
- Category B (minor inspections, small-scale repairs and checks).

The qualification is valid for 24 months and may be renewed for periods of the same duration, subject to submission of the prescribed certificate of physical fitness and provided the holder has been employed for at least 10 of the previous 24 months.

1.18.6. Maintenance instructions for replacing the FQI

The Job Instruction Card (JIC) applicable on the date of the occurrence (Attachment “C”) for the replacement of the FQI did not prescribe either a check on congruity between the FQI readings and the data entered in the aircraft records or a check to establish whether the FQI readings before and after replacement were the same/consistent. It only prescribed ensuring that the post-installation test designed to light up the LO LVL warning light and all the LEDs on the two FQI displays had been carried out. Nor did the JIC require the accuracy of the instrument reading to be checked using the dripsticks inserted into the undersides of the wings.

The manufacturer amended the JIC in question in April 2006, prescribing a series of measures designed to check FQI reading congruity before and after replacement (Attachment “C”).

1.18.7. Fuel quantity indicator Part Number identification

The FQI manufacturer has produced various versions of the same instrument for ATR aircraft, which differ in applicability (ATR 42 or ATR 72), unit of measure used to express the fuel quantity indicated (kg or lb) and improvements introduced over time.

The following table sets out the applicability, unit of measurement in which the fuel quantity is expressed and modification standard for all the FQIs currently applicable to ATR aircraft, each identified by a different Part Number.

Version	ATR 42	ATR 72	Notes
Reading in kg, initial version	748-465-5	748-681-2	No longer in production
Reading in lb, initial version	748-522-2	748-682-2	No longer in production
Reading in kg, new version (1992)	749-158	749-160	No longer in production
Reading in lb, new version (1992)	749-159	749-161	No longer in production
Reading in kg, with Low Level modification (ETOPS)	749757	749759	
Reading in lb, with Low Level modification (ETOPS)	749758	749760	

Table 13: FQIs applicable to ATR Aircraft.

The Part Numbers are those given in the applicable Component Maintenance Manuals (CMM's) 28-42-81, 28-42-82 and 28-42-83 published by the FQI manufacturer.

It is pointed out that only in the latest CMM, 28-42-83, is the hyphen dropped after the first three figures of the Part Number (P/N); however, during a visit to FQI's manufacturer premises and from the observation of some FQI's produced in December 2004 (photo 83) and April 2005 (photo 84), it has been noted that the identification plates attached to the instruments continue to feature it.

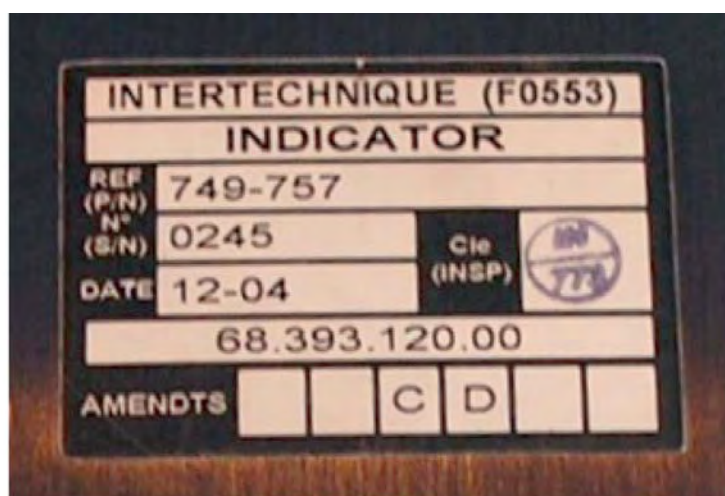

Photo 83: FQI Identification Plate.



Photo 84: FQI Identification Plate.

On the contrary, the plate attached to instrument P/N 748681-2 S/N 179 (see Photo 80), which was removed from TS-LBB, has no hyphen after the first three figures.

The FQI manufacturer has stated that the hyphen following the first three figures was dropped in 1992 for computer system reasons. The same manufacturer has house regulation governing Part Number allocation methods, however, the regulation itself has not always been applied systematically.

1.18.8. Preventive measures

1.18.8.1. ANSV

After analysing the technical documentation submitted by the TS-LBB operator, and prior to completion of the examinations conducted on the wreckage to ascertain the causes of dual engine flame-out, the occurrence that led to ditching, ANSV submitted two safety recommendations to the EASA (European Aviation Safety Agency) on September 6th, 2005. They are cited in Chapter IV of this report and set out in full in Attachment “D”. The purpose of said recommendations was to inform the EASA promptly so as to enable it to appraise the advisability of issuing mandatory instructions to ATR 42 and ATR 72 operators to ascertain whether the right FQIs for the types of aircraft concerned were installed in their ATR 42 and ATR 72 fleets and to ensure that no FQIs designed for the ATR 42 were erroneously installed on ATR 72s or *viceversa*.

It emerged, indeed, from an examination of the documentation acquired by the ANSV in Tunisia and from the inspections conducted on the wreckage, that the display that indicates the quantity of fuel in the wing tanks (FQI) installed in ATR 72 TS-LBB's cockpit was of the type intended for ATR 42 aircraft.

In order to establish the consequences of erroneous installation in terms of fuel quantity indicated in the cockpit, the ANSV conducted numerous refuelling trials on an aircraft of the same type as the one that crashed, using both the FQI designed for the ATR 72 and the FQI designed for the ATR 42 as previously reported. The results of the trials showed that if an FQI designed for the ATR 42 is installed on an ATR 72, it gives a fuel-on-board reading higher than the quantity actually present.

In the light of the above findings, the ANSV thus issued the two aforementioned safety recommendations (ANSV-6/443-05/1/A/05 and ANSV-7/443-05/2/A/05).

In particular, the former urged the EASA to ascertain whether Fuel Quantity Indicators of the type intended for the type of aircraft concerned were installed on the ATR 42 and ATR 72 fleet. Whereas the latter suggested that the EASA might consider the possibility of having a fitting modification made to prevent an FQI intended for the ATR 42 from being fitted on an ATR 72. At a subsequent stage, after acquiring further data on the refuelling operations performed, the records entered in the aircraft's on-board documentation and an estimate of fuel consumption on the flight from Tunis to Bari (flight TUI 152F) and from Bari to Djerba (flight TUI 1153) from takeoff to ditching, it proved possible, in particular, to reconstruct the quantity of fuel actually left in the tanks and the instrument readings available to the crew at the various stages in the two aforementioned flights.

ATR 72 TS-LBB's fuel system was fitted with a low fuel level warning system directly dependent on the indicator system, as triggering of the low fuel level warning was controlled by the FQI instrument. The same applies to ATR 42-200 and -300 version aircraft.

As a result, despite the fact that the quantity of fuel actually left in each tank fell below 160 kg per tank both on the Tunis-Bari flight and on the flight that ended in ditching, the low fuel level warnings were not triggered.

The certification regulations currently in force – “EASA Certification Specification 25 – Large Aeroplanes” (which replaces the previous JAR-25), applicable to the ATR 42 and ATR 72 class of aircraft, do not specifically prescribe the installation of a low level warning system for the fuel system independent of the fuel quantity indication system.

In the light of the aforementioned considerations, the ANSV submitted a third safety recommendation to the EASA (ANSV-13/443-05/3/A/05 – see Chapter IV) suggesting that it

consider the possibility of amending the current regulations governing the certification of fuel systems for aircraft used for public transport with a view to making a low level warning system independent of the fuel quantity indication system a mandatory requirement.

The ANSV was able to attend a number of the tests and inspections conducted on the aircraft's components and systems in an observer capacity. In particular, after taking part in the engine teardown operations, the technical and maintenance anomalies that emerged during said operations were reported in advance to the ENAC (Italian Civil Aviation Authority). In particular, the difficulty of precisely identifying the engine parts, primarily on account of the vagueness of the entries made in the available documentation, was highlighted. In general, what emerged was poor maintenance organization and substandard installation practice that may not have been such as to jeopardise the working of the engines, but were indicative of potential maintenance shortcomings on the part of the operator.

1.18.8.2. EASA

The EASA took up the first safety recommendation (ANSV-6/443-05/1/A/05) in concrete form by approving an Emergency Airworthiness Directive (Ref. GSAC/T 50/05- AD N° UF-2005-160 dated 8 September 2005) issued by France's DGAC, which prescribed a one-off (*una tantum*) inspection on ATR 42 and ATR 72 aircraft to ascertain that the right fuel indicators had been fitted.

With regard to the second recommendation (ANSV-7/443-05/2/A/05) on the possibility of making a fitting modification to prevent an FQI intended for the ATR 42 from being fitted on an ATR 72 aircraft, EASA partially accepted the safety recommendation and initiated a review of practical prevention means. However, the EASA ATR Certification Team did not initially define any corrective actions, since further information were awaited. EASA expressed the intention of taking specific action regarding the matter only after a similar occurrence (erroneous replacement of the FQI on an ATR 72) was repeated, as was the case with a European operator on March 18th, 2006. Specific details on said occurrence are set out in the following paragraph 2.9.2.

On the other hand, with regard to the third recommendation (ANSV-13/443-05/3/A/05), which has been taken up in full, EASA has set proceedings in motion to amend the current CS-25 certification regulations to make specific provision for the installation of a low level warning system independent of the fuel quantity indication system.

In particular, a working group will be formed in late 2007 to draft a proposed amendment to CS-

25 (Notice of Proposed Amendment, NPA) to make it mandatory for the low level warning system to be independent of the fuel indication system.

1.18.8.3. ATR

Concomitantly with the submission of the first safety recommendation, ATR issued AOM 42-72/2005/08, in which it emphatically drew the attention of all operators to the necessity of applying the procedures correctly and of identifying the parts' P/N as stated in the applicable illustrated parts catalogues or manuals (IPCs), so as to avoid installing the wrong components.

The maintenance instructions (Job Instruction Card, JIC 28-42-81 RAI 10000 – Attachment “C”) in force prior to the occurrence allow the FQI to be replaced without checking that the fuel quantity readings given by the new component are congruent with those given by the one being replaced and/or checking the indications provided by the dripsticks positioned under each wing, level with the respective tank.

ATR, by its own initiative, as a further prevention measure, amended the JIC with regard to FQI replacement in April 2006, including the congruity check between the fuel quantity indicated on the FQI display and the level actually contained in the wing tanks in the checks to be conducted after fitting.

With regard to the requirement for the low level warning to be independent of the fuel indication system, it must be pointed out that ATR had introduced the appropriate installation amendment in the past (for the ATR 72 version with the Service Bulletin ATR72-28-1013 of 14 December 1998 and for the ATR 42 with the Service Bulletin ATR42-28-0033 of 12 July 1997); such modification was, however, mandatory only for ETOPS (Extended Twin Engine Operations) certified aircraft. Said configuration has subsequently been standardized for the ATR 72 since October 1997 starting from MSN 529 and for the ATR 42 since May 1998 from MSN 561.

1.18.8.4. ENAC

Immediately after the first two safety recommendations were issued, ENAC provisionally suspended the TS-LBB operator's operational activity in Italy. It subsequently paid technical visits to the operator's premises in Tunisia, at the specific request of the operator, to inspect, its technical, operational and maintenance standards on the spot.

The ENAC technicians made some inspection visits, during which they checked the operating methods adopted in both technical operations and maintenance management, primarily with reference to the content of ICAO Annex 6 and, in part, with reference to the European standards

deriving from the application of JAR OPS 1 and Regulation 2042/2003 Part M/Part 145.

The main findings are listed below.

- Organizational discrepancies in the performance and recording of maintenance work carried out on the engines.
- The maintenance personnel failed sometimes to demonstrate an ability to interpret the manufacturer's documentation for the purposes of establishing the acceptability of components with different P/Ns.
- Some maintenance job cards did not state the revision of the applicable engine manufacturer documentation.
- There was no evidence of double checks being conducted on newly fitted engine controls.
- Procedures for unscheduled maintenance intervention off-base were not reported in the Maintenance Manual Control, in terms of indication of personnel responsible, preventive planning and verification of adequacy of the base.
- Inaccuracy of data fed into the ®AMASIS spare parts management system and lack of effective monitoring of the system itself; indeed, no one is identified as being in charge of it; this is a critical aspect of maintenance management and aircraft configuration monitoring. ANSV verified that the Technical Department personnel has not been given training in the use of the AMASIS system by the supplier (the French firm IFR).
- Airworthiness Directives management procedures did not account for the traceability of the implementation, as far as the responsibility was concerned.
- Substandard technical management and aircraft maintenance procedures that made the identification of the roles and responsibilities of the personnel involved in the various technical and maintenance operations muddled and not unambiguously specifiable.

To sum up, from the above evidences, the operator's maintenance and organizational standards were considered critical.

1.18.8.5. Action taken by the Operator

With a view to making good these organizational and maintenance shortcomings, the operator has made, with the support of an foreign institution expert in certification, a series of structural and organizational changes that enabled it to obtain quality system certification to ISO 9001 standards for the "Marketing of domestic and international scheduled and charter passenger flights" between the end of 2005 and the beginning of 2006. It has to be pointed put that ISO 9001 certification process had already started in 2004, before the accident.

Further action taken is set out in detail in the following paragraph 2.11.

1.18.8.6. Conclusive action

Subsequent checks conducted by both the ENAC, within his competence and the ANSV in connection with the latter's technical investigation, have made it possible to establish that the corrective action called for in the wake of the inspections has been implemented.

In particular, the following requirements have been deemed met and fulfilled:

- a quality assurance system have been put in place for both maintenance and operations aspects;
- a new model for the logbook has been introduced;
- the aircraft spare parts and configuration management system (®AMASIS) has been reviewed.

The ENAC, the Tunisian civil aviation authority (DGAC) and the operator itself have, furthermore, agreed that the subsequent monitoring of the technical and operational work and compliance with the safety standards will, at least in the initial period following any granting of a licence to engage in public transport business in Italy, be conducted in the form of joint DGAC Tunisia and ENAC audits.

The inspection findings on the operator were brought from ENAC to the attention of the European Commission Air Safety Committee in March 2006 so that it would have all the evidence for assessing the possibility of keeping the operator involved in the occurrence off the list of carriers to be banned (the so-called "black list") from operating on the soil of the member states of the European Union.

Once said list, on which the operator concerned had not been entered, had been published, the ENAC revoked the suspension of the licence to perform flight operations on Italian soil on April 2006.

1.19. USEFUL OR EFFECTIVE INVESTIGATION TECHNIQUES

Not pertinent.

CHAPTER II

ANALYSIS

2. GENERAL CONSIDERATIONS

The analysis expounded in this chapter was made on the basis of the evidence gathered by ANSV on the strength of the powers granted under the national and international statutes governing the conduct of technical inquiries into air accidents and incidents.

The aircraft involved in the occurrence was being used in public passenger transport operations and had all the requisite certificates.

The pilots were trained and qualified to operate the flight. Both pilots held a current pilot's licence and had also passed the periodic professional checks and medical examinations. The flight attendants were also qualified to operate the flight. The aircraft held current airworthiness certificate.

2.1. PREPARATIONS FOR THE FLIGHT

2.1.1. Quantity of fuel on board the aircraft

The handling of the fuel quantity during the flights made on 6 August 2005 by TS-LBB has been reconstructed in detail by examining the data on the fuel consumed on the previous leg, Tunis-Bari (flight TUI 152F), and from takeoff from Bari to ditching (figures established from the FDR analysis), the data on quantity taken on board (established by the refuelling documentation gathered), and the quantity actually on board the aircraft prior to departure from Tunis on the morning of August 6th, calculated taking account of the false FQI reading.

Table 14 below summarizes the foregoing (a margin of error of approximately $\pm 2-3\%$ should be considered for the figures stated).

Date	Airport / flight	Duration of flight	Fuel taken on (kg)	Fuel actually on board ²² (kg)	Total fuel on board indicated by the ATR 42 type FQI (kg)	Fuel consumed (kg)	Notes
5 August 2005	Tunis	---	----	790 Figure entered in the on-board documentation after the day's last flight (Catania-Tunis).	3050 After the FQI replacement, the fuel quantity indicated was 3050 kg. ²³ . No check on congruity between the fuel quantity indicated by the instrument (FQI) and the quantity actually left in the tanks was prescribed after its replacement.	----	FQI replaced following the report from the crew after the day's last flight (Catania-Tunis, flight TUI 1141). The flight TUI 1141 captain who made the report was the one involved in the occurrence (TUI 1153).
6 August 2005	Tunis	---	465 (equivalent to 600 litres).	1255 (790 + 465)	3780 The total figure indicated by the FQI after taking on 465 kg. Indeed, considering the law of variation (see footnote 23), with 1255 kg fuel actually on board, the figure indicated by the FQI is about 3780 (+/- 20 kg)	----	Refuelling was performed via the aircraft's central refuelling port. Quantity set in the panel so as to have a total quantity of 3800 kg (figure notified by the copilot to the flight dispatcher for the preparation of the load and balance sheet).
6 August 2005	Tunis – Bari (flight TUI 152F)	about 101 minutes.	----	305 Quantity of fuel on board after landing at Bari. This figure has been calculated from the difference between the fuel on board prior to takeoff (1255 kg) and that actually consumed during the flight (950 kg).	2290	950 Figure established from the FDR data.	Ferry flight from Tunis to Bari with 1 passenger (airline mechanic)

Date	Airport / flight	Duration of flight	Fuel taken on (kg)	Fuel actually on board ²² (kg)	Total fuel on board indicated by the ATR 42 type FQI (kg)	Fuel consumed (kg)	Notes
6 August 2005	Bari	----	265 (equivalent to 340 litres)	570 (equivalent to 305 kg left on board after landing + 265 kg taken on).	2700		Refuelling was performed via the centralized refuelling port. The quantity set is 2700 kg, as stated in the load and balance sheet. With this setting, the quantity calculated by the FQI being 2700 kg, the total taken on was 265 kg (340 litres).
6 August 2005	Bari – Djerba (Flight TUI 1153)	About 66 minutes from takeoff to ditching.	-----	0 (at the time of dual engine flame out).	1800	570 Figure established from the FDR data.	The aircraft took off with about 540 kg fuel (30 kg were consumed during the taxiing operations). About 49.5 minutes elapsed from takeoff to flame out in the RH engine. Flame out in the LH engine occurred about 100 seconds later.

Table 14: Quantity of fuel on board aircraft TS-LBB.

²² To be considered as the fuel usable for supplying the engines.

²³ With an ATR 42 type Fuel Quantity Indicator installed on board an ATR 72, the fuel quantity indicated obeys the following law of variation, determined experimentally: $Y = 1,572 X + 1807,8$ (in which X is the quantity of fuel actually carried on board). For example, with 600 kg fuel actually on board, the quantity indicated by the ATR 42 type FQI will be about 2750 kg.

The graph shown in Figure 27 gives the quantity of fuel actually on board (blue line) and the quantity indicated by the FQI (red line) for each stretch flown by TS-LBB.

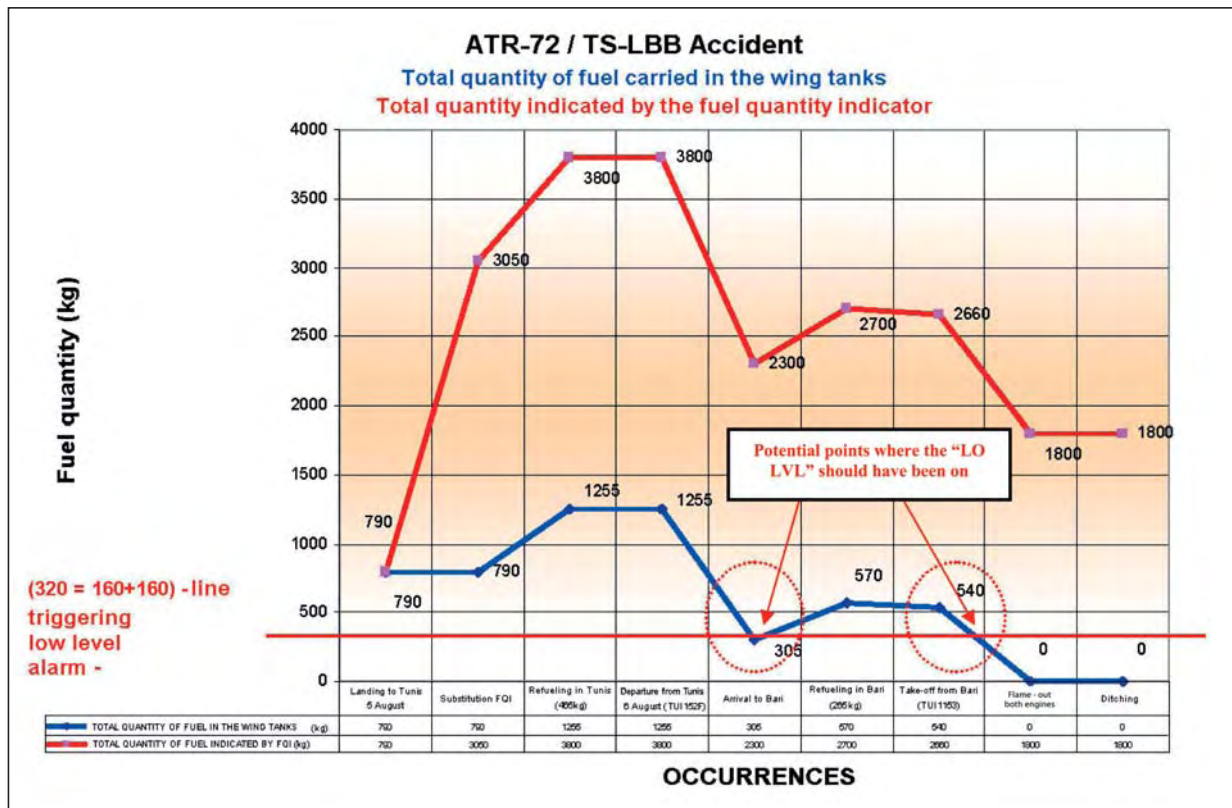

Figure 27: Quantity of fuel indicated (red line) and actually on board (blue line). Note: a margin of error of approximately $\pm 2-3\%$ should be considered for the figures stated.

2.1.2. Considerations

As illustrated in Table 14 above, the quantity of fuel actually carried on board after engine flame-out was 0 kg, although the, erroneous, quantity indicated by the FQI was 1800 kg (900 in the LH wing tank + 900 in the RH tank). Experimental tests have confirmed, indeed, that with the fuel tanks of an ATR 72 completely empty, the quantity indicated by an ATR 42 type FQI is approximately 1800 kg. As will be seen in greater detail below, the dual engine flame-out was caused by lack of fuel in TS-LBB's wing tanks.

The aforementioned table also shows that the quantity actually on board upon arrival at Bari was about 305 kg and that the quantity indicated by the FQI was about 2300 kg (a figure confirmed, what is more, by the crew members). The FQI features two warning lights (with the wording "LO LVL" beside them) to indicate a low fuel level in the respective tank. The amber warning light lights up when the fuel quantity in the tank concerned is less than 160 kg.

In addition to the amber warning light, an aural warning is also set off in the cockpit (Single Chime) in the event of the FQI calculating a quantity lower than 160 kg in one of the two tanks. Both the lighting of the amber warning light and the triggering of the aural warning thus depend on the fuel quantity calculated by the FQI. The FQI, of course, supplies the crew with the mass of the fuel quantity (figured in kg or in lb) carried in the tanks, using a characteristic algorithm that depends on tank shape and size and number of probes to process the signal emitted by the capacity sensors installed in the wing tanks. The fuel system ATR 72 TS-LBB was not fitted with a low fuel level indicator independent of the indication system. In other words, the low level signal depends on the quantity that the FQI calculates in the light of the signals coming in from the capacity sensors in the wing tanks.

In the case in point, despite the fact that the quantity of fuel actually left in each tank fell below 160 kg per tank both on the Tunis-Bari flight and on the flight that ended in ditching, the low fuel level warnings (amber light on the FQI and the associated aural warning) were not triggered in the cockpit.

By indicating a fuel quantity on board over 900 kg higher per tank than the quantity actually carried, the ATR 42 type FQI mounted on TS-LBB thus failed to trigger the amber warning light and the associated single chime in the cockpit.

2.2. FLIGHT OPERATION AND FAILURE MANAGEMENT

2.2.1. Flight TUI 152F (Tunis-Bari, ferry flight) and refuelling operations in Bari

On August 6th, 2005, flight TUI 152F had been planned using the aircraft registered as TS-LBB and was scheduled for 10.00 hours UTC (12.00 hours local time).

The crew prepared for the flight, in terms of total quantity of fuel to be taken on and routing, in compliance with the operating procedures laid down. The captain, however, despite noting the absence of the fuel slip certifying that the fuel had been topped up from 790 kg (the quantity of fuel left after the previous day's last flight) to about 3100 kg (fuel quantity indicated by the FQI), decided nevertheless to make the flight without checking a copy of said fuel slip.

The crew did not thoroughly check out the reasons for the lack of the slip for refuelling from 790 to 3100 kg and trusted in the assurances given by the Flight Dispatcher. In actual fact, there was no such slip, as the difference in fuel readings was due to the erroneous replacement of the FQI,

and not to actual refuelling. A diligent search for the aforementioned slip, which would have proved negative, making enquiries of the refuelling company as well, would undoubtedly have led the crew to suspect that the fuel reading was not entirely reliable, and hence to investigate further.

As the documentation regarding the quantity of fuel on board was incomplete, the captain should have consulted the flight operations director for instructions on the action to be taken. In the case in point, this was not done.

After ordering the fuel to be topped up to a total of 3800 kg (*block fuel*) for the flight from Tunis to Bari and receiving the refuelling slip, the captain failed to notice that only 465 kg (600 litres) had been supplied instead of the 700 kg (about 900 litres) that were to have been added. The same applies to the technician who assisted the refuelling operator alongside. Indeed, the procedure is for the technician to set the overall quantity of fuel on the display provided for the purpose and then to assist the tanker operator in the refuelling operations, subsequently signing the fuel slip and handing it to the crew.

Once refuelling had been completed, the FQI, which was of the ATR 42 type, in any case showed a total of about 3800 kg (distributed between the two tanks) instead of the 1255 kg of fuel actually carried on board.

The crew detected no particular anomalies during the flight, and TS-LBB landed normally at Bari after about 101 minutes, at approximately 11.46 hours (13.46 local time). The flight time had been as scheduled.

The operational flight plan was not compiled during the flight, even though requested as per company operational procedures. Said document details the factors (routes, distances, times, fuel etc.) in consideration of which the flight has been planned and includes a record, compiled by the crew during the flight, of the salient check data and other essential data.

The crew thus notes times and consumption in the operational flight plan and checks, on reaching specific points in the flight, the quantity of fuel consumed, collating it against the planned quantity. It emerges from the documentation gathered that the operational flight plan was not compiled systematically despite being required by company procedures. Had it been compiled during the flight concerned, the crew would probably have noted a fuel consumption anomaly²⁴ and carried out the requisite checks. As seen above, the total fuel quantity indicated on departure from Tunis was about 3800 kg and the quantity planned for consumption on the stretch (trip fuel) was 1100 kg (Attachment “F”). After landing at Bari, the quantity indicated by the FQI was 2300 kg, making for a fictitious consumption of 1500 kg, 37% greater than planned.

²⁴ Difference between the FF/FU reading and the quantity indicated by the FQI

The Fuel Used (FU) indicator readings would, moreover, have given a fuel consumption figure (950 kg) compatible with the consumption planned, but incompatible with the FQI indication. In fact, the crew failed to notice the discrepancy, which could have suggested that there might be an indication and/or anomalous fuel consumption problem and prompted the requisite checks. The fact that the discrepancy went undetected also suggests that the crew had not completed the part of the Performance Record that requires noting the quantity of fuel supplied, the quantity actually consumed, stating the flight instrument readings, and the quantity remaining. The figures for the fuel actually used for each engine are indicated in the cockpit by the FF/FU indicators, whose values are totally independent from the FQI indication.

The flight crew has reported that it compiled the Performance Record but failed to notice the incongruity. However, it has not proved possible to check the claim out, as the Performance Record kept on board the aircraft has not been found.

2.2.2. Flight TUI 1153 (Bari-Djerba) – Takeoff and cruise phase

The 35 passengers (one of whom was the airline engineer who travelled with the aircraft every time it flew into and out of airports where the operator had no technical assistance facility of its own) were boarded as normal. As pointed out above, after refuelling in Bari, the fuel quantity indicated was about 2700 kg, with about 570 kg actually in the tanks.

It has in any case been possible to establish from the fuel flow data that the fuel quantity was about 540 kg at the time of takeoff. Indeed, about 30 kg were consumed during start-up and taxiing operations. The overall mass of the aircraft was thus about 17.250 kg, whereas its “fictitious” mass (considering a fuel quantity of $2700 - 30 = 2670$ kg) was little over 19.000 kg. There was thus a difference of about 2000 kg. Albeit significant, the difference in mass is not easily detectable by the pilots, as other variables, in addition to mass, help determine aircraft performance.

It will be noted from the graphs shown in Figure 28 that the engine parameters were normal and within the prescribed limits in the takeoff and climb to initial cruising altitude phase. The flight thus went off normally, without any aspect of particular note, from takeoff from Bari airport until the first engine flame out (right engine). The data extracted from the FDR regarding the working of the two engines suggest nothing out of the ordinary throughout the whole of the phase preceding the RH engine shut down.

The temperature, engine speed and fuel flow readings were, in fact, within normal values, as

illustrated in the graphs in Figure 28. Fuel consumption was normal and settled at a rate of about 10 kg/min in the cruising phase (graphs in Figure 29).

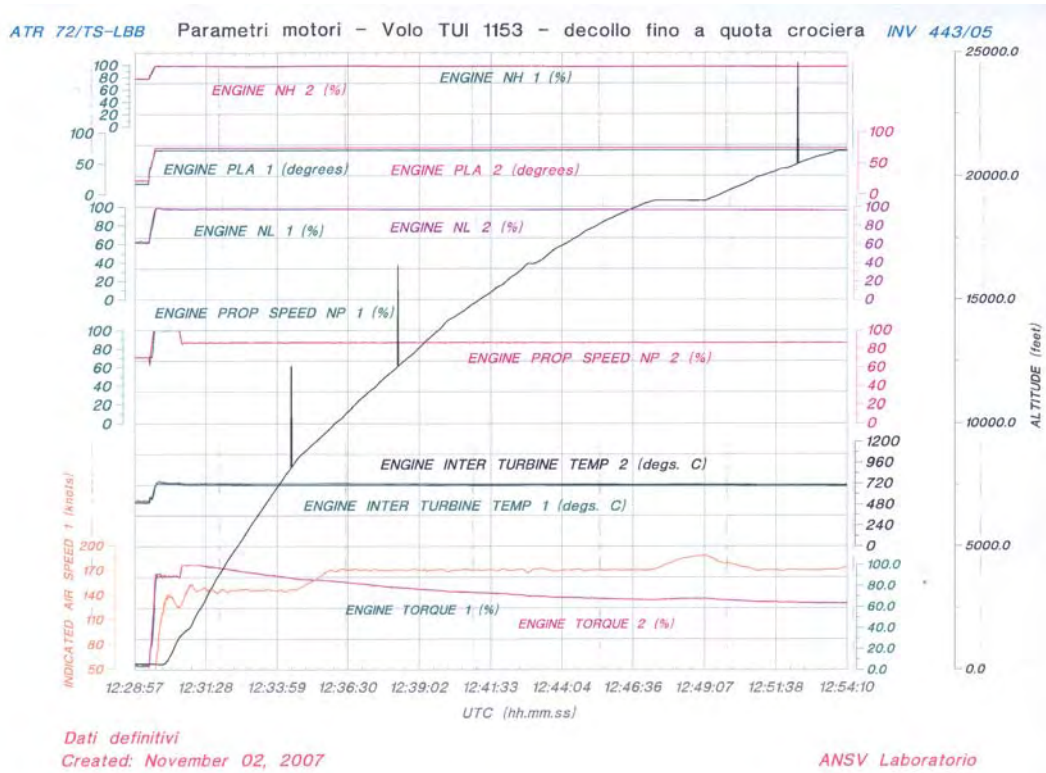

Figure 28: Pertinent engine parameters from takeoff to initial cruising altitude.

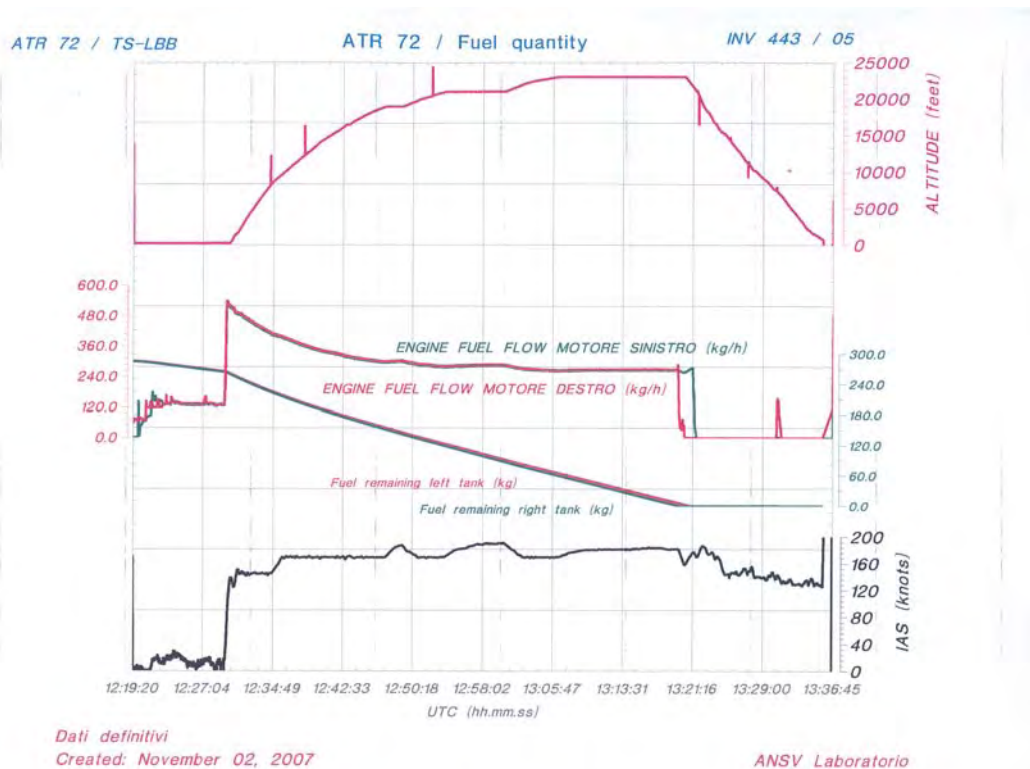

Figure 29: Fuel quantity and consumption status. “Fuel remaining” parameter is determined from the fuel flow data and it is not directly recorded by the FDR

2.2.3. Cockpit operations analysis – Engines failed

An analysis of the cockpit conversations that emerge from the CVR, plus the FDR data regarding aircraft altitude and speed parameters and the information supplied by the flight crew, have made it possible to reconstruct the action taken by the crew at the time when the first failures occurred. Figure 30 illustrates the main engine operation parameters; it may be seen that both engines shut down in linear fashion, without increases in internal temperature or an abrupt increase/decrease in speed in either engine.

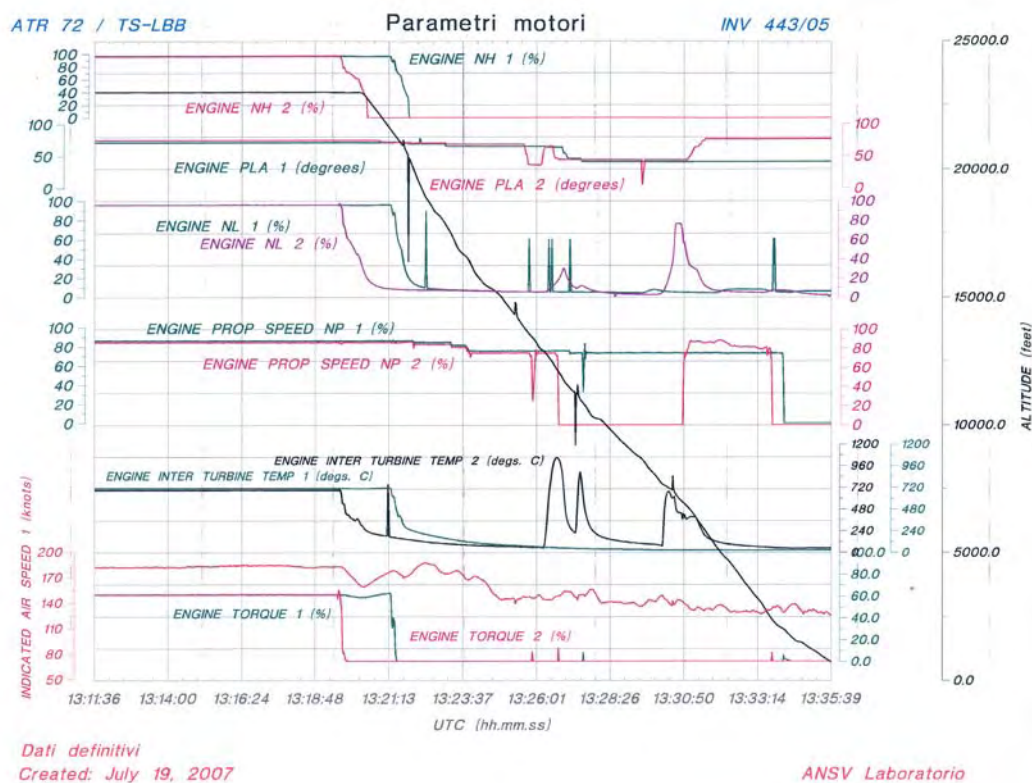

Figure 30: Pertinent engine parameters.

Right engine failure

The first indications of malfunctioning to reach the cockpit were the amber “FEED LO PR” and “FUEL” lights illuminating on, respectively, the fuel panel and the Crew Alerting Panel (CAP), accompanied by the associated single chime.

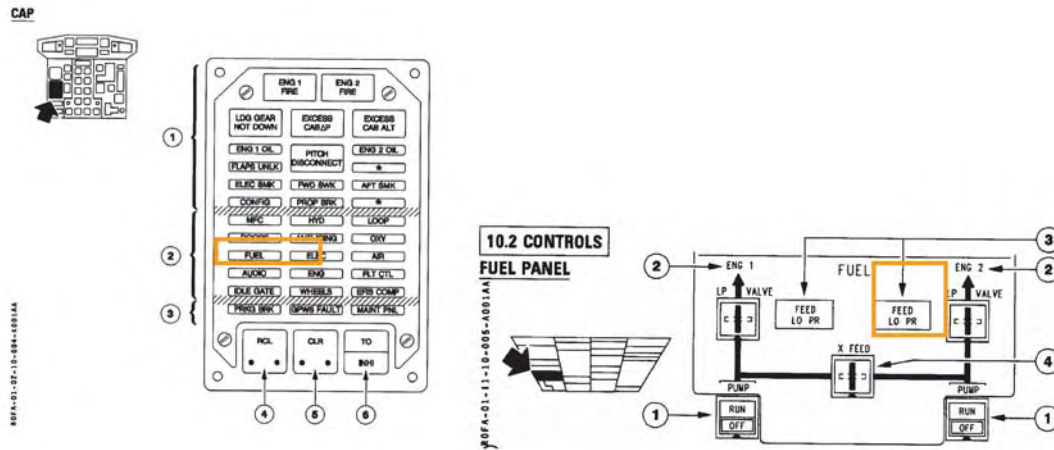

Figure 31: CAP and Fuel Panel.

The “FUEL” warning light on the CAP lighting up alerts the crew to an abnormal situation requiring corrective action, and the “FEED LO PR” warning light illuminates whenever the pressure of the fuel flow into the engine concerned falls below 350 mbar (5 psi). This is a sign of a possible fuel pump failure, a suspected fuel leak in the fuel ducts, or shortage of fuel. In the case in point, it was a sign of shortage of fuel.

Upon the chime indicating the aforementioned situations being heard in the cockpit, the captain informed the copilot that the FUEL warning light on the CAP had illuminated and, foreseeing that the engine might fail, he asked the copilot to coordinate a lower altitude with air traffic control. The request to descend was dictated by the fact that, with a single engine running, the aircraft’s reduced performance did not allow it to maintain an altitude of 23.000 ft. Indeed, the performance table gives a maximum altitude lower than 19.000 ft (reference mass in the 17.000 to 19.000 kg range).

He subsequently asked for the check list for the “FEED LO PR” warning light coming on to be read, but decided at once to halt the reading and ordered the copilot again to request a descent. Before a start was made on reading the check list, the captain noticed that there had actually been an engine flame out, a circumstance confirmed simultaneously by the CRC (continuous repetitive chime) alerting the crew to the low oil pressure, and called for the Engine Start Rotary

Selector to be positioned on “CONT RELIGHT” (so as to attempt an immediate re-ignition and, at the same time, ensure a constant supply to the engine igniters) and for the PLs to be positioned on FI (flight idle). These two latter actions are the first two items on the “ENG FLAME OUT” check list (page 2.10 of the QRH). At the same time, the copilot began performing the checks prescribed on the “FEED LO PR” check list (page 2.13 of the QRH); this process, as will be seen below, was broken off on account of the shut down of the LH engine.

The check list applied in response to the acoustic and visual warnings in the cockpit was in line with the information available to the crew, although the PL’s were not positioned on FI. Performance of the items on the “FEED LO PR” check list would, in the absence of further failures, have enabled the crew to handle a single engine failure correctly by referring it to the “SINGLE ENG OPERATION” procedure (page 2.04 of the QRH).

An examination of the RH engine propeller revolutions (NP) reveals that they remained high and constant, as the CL’s were not retracted into the feather (FTR) position, and the propeller kept up the same number of revolutions as it did with the engine running as a result of windmilling²⁵. The engine design, known as free turbine, is characterised by the fact that the propeller rotation speed (measured by the NP parameter) is independent of the gas generator compressor-turbine unit speed (low and high pressure compressor rotation speeds measured by the NL and NH parameters respectively).

The CLs were not retracted into the feather (FTR) position as the check list reading was broken off, seeing that the second engine had failed.

The copilot coordinated the descent, initially to level 190, telling to Rome ACC that they had “technical problems,” without specifying the type of failure that had occurred.

Left engine failure

About 100 seconds after the RH engine had shut down, with the aircraft at an altitude of about 21.500 ft, in descent towards 19.000 ft, the LH engine shut down. Flame out occurred while the checks prescribed in the “FEED LO PR” check list (page 2.13 of the QRH) were being carried out 2.13 for the RH engine. The captain thus asked the co-pilot to break off reading the check list and to report the intention of diverting to Palermo Punta Raisi airport. The aircraft, with both engines failed, descended through altitude 20.000 ft after about 42 seconds; during the descent, the crew attempted to find out what the cause of the dual failure might be.

The crew did not perform the checks laid down in the check list – emergency section – in the

²⁵ Windmilling: condition in which an engine propeller continues to rotate under the effect of airspeed. This generates enormous aerodynamic drag.

event of dual engine flame out (“BOTH ENGINES FLAME OUT” – page 1.03 of the QRH), but attempted to find out the reasons for the sudden flame-out in both engines from the indications furnished by the other cockpit instruments and reported the emergency situation to the controller in radio contact (MAYDAY declaration).

Prior to attempting re-ignition, the aforementioned procedure (“BOTH ENGINES FLAME OUT”) prescribes achieving and maintaining what is known as drift-down speed (V_{mHB} , optimum descent speed). This speed is given in the OPS DATA section in the QRH; with an aircraft mass of 17.000 kg, as in the case in point, said speed is about 129 knots with flaps 0°, and 137 knots for an aircraft mass of 19.000 kg (dotted line in figure 32). At the time of the second failure, the aircraft was flying at a speed of about 180 kts, and the flight crew in any case maintained speeds considerably higher than those prescribed by the procedure down to an altitude of about 6000 ft. As will be seen, moreover, from the speed graph shown in Figure 32, which covers the final phase of the flight after both engines had shut down, the speed varied considerably over time. However, as was also confirmed by the tests performed on the flight simulator, it is no easy matter for a flight crew to succeed in maintaining a constant speed profile throughout an emergency similar to the one that involved TS-LBB. This is primarily so because of the difficulty of using the emergency instruments provided with a reduced electrical supply (airspeed indicator, stand-by horizon, altitude and vertical speed indicator) and the practical problems encountered in handling and operationally manage the flight.

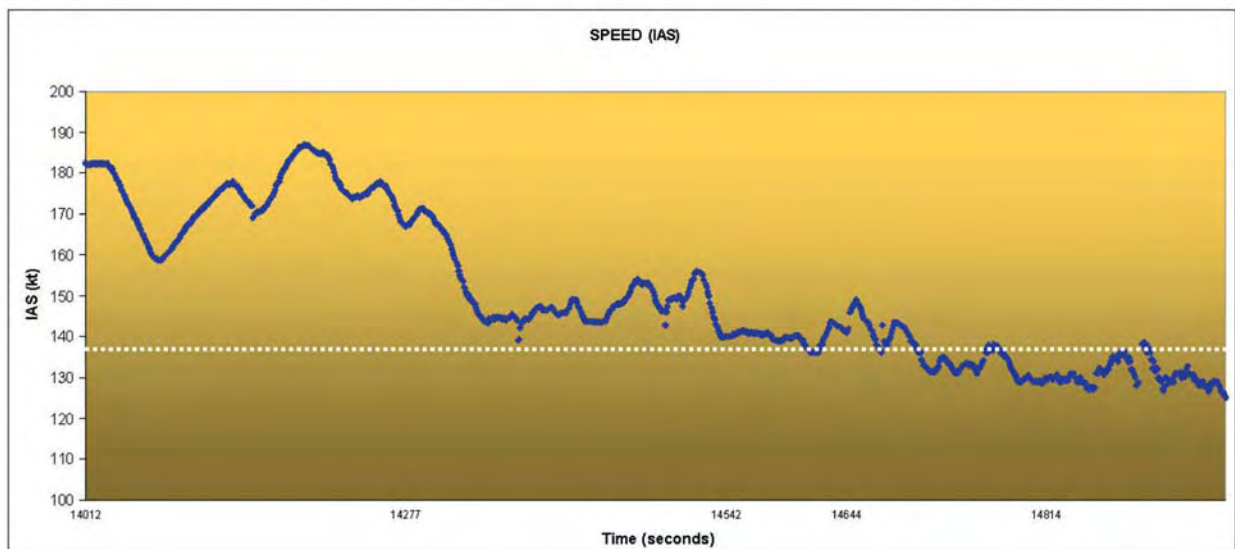

Figure 32: Indicated Air Speed (IAS) final phase recorded by FDR.

As pointed out in the foregoing, the captain called for no procedure to be implemented after the flame-out in the second engine. The one that should have been applied was “BOTH ENGINES FLAME OUT.” In particular, it prescribed positioning the CLs on FTR (feather) and SO (Shut Off) so as to feather the propellers and shut off the fuel flow. The unfeathered propellers created considerable drag to aircraft headway, and this undoubtedly contributed to its losing altitude faster than it would have done with the propellers feathered and, consequently, travelling a shorter horizontal distance.

The table in Attachment “H” details the sequence of pertinent actions performed in the cockpit over the 17-minute interval between flame out in the first engine and ditching.

Whereas Figure 33 shows the same sequence in diagram form, taking aircraft altitude as the base parameter.

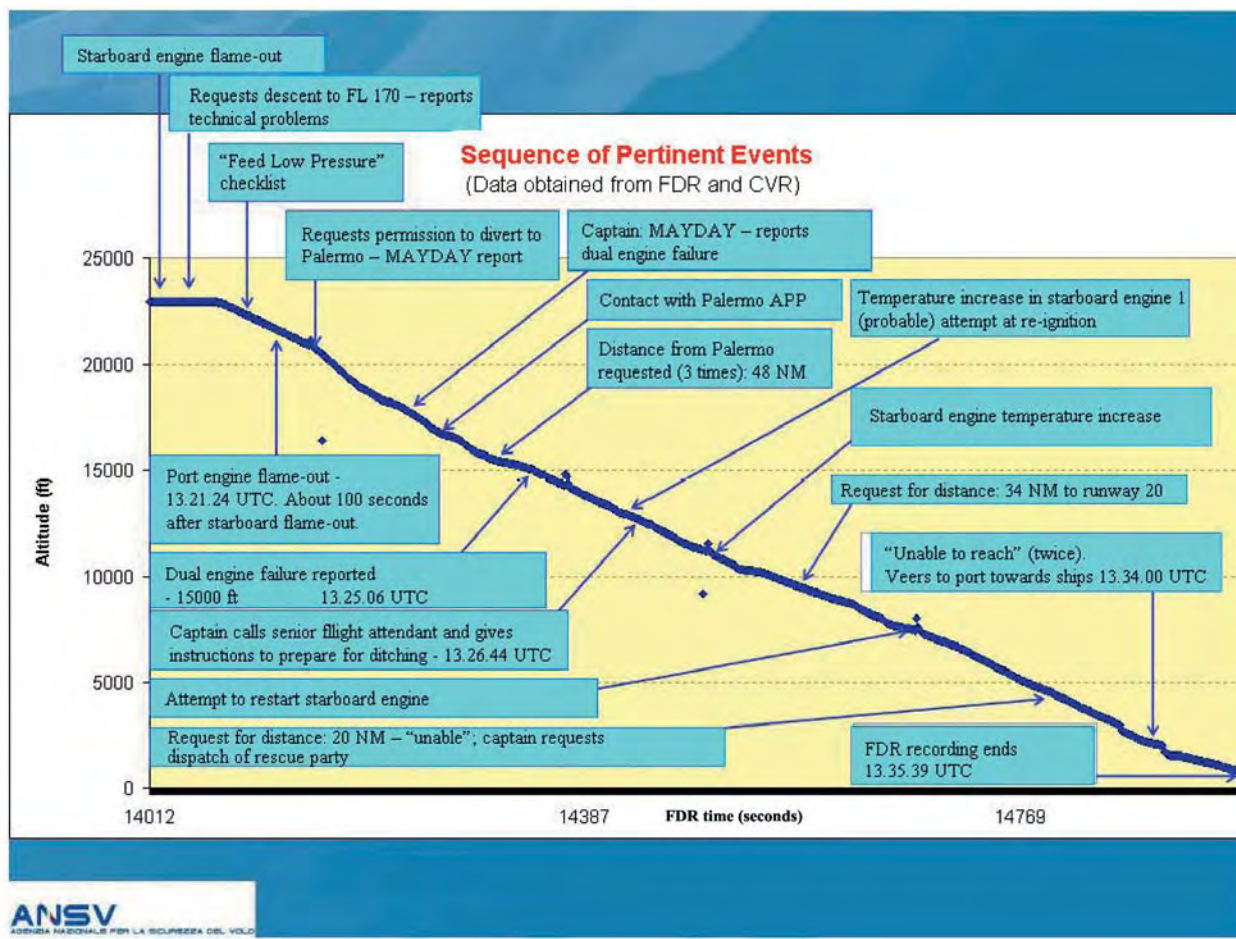

Figure 33: Sequence of pertinent events.

With a view to providing a better account and reconstruction of the measures adopted by the crew, Attachment “I” contains two videos providing an animated reconstruction of the event, illustrating the aircraft itself in 3D and a number of flight and engine operation parameters obtained from the FDR, commencing from the takeoff from Bari and from the first engine flame out, extending to the final phase of ditching the aircraft (concise view of the instruments and outside view).

According to the accounts given by the flight crew, several attempts were made to restart the engines. Indeed, it may be seen from an examination of the engine operation parameters that there were temperature increases to NL²⁶, but it is to be noted that the PL and CL positioning was not in line with the procedure prescribed for in-flight re-ignition.

The situation in the cockpit was marked by understandable anxiety, in particular after air traffic control reported the distance from Palermo for the first time. Indeed, the aircraft was flying at about 15.000 ft at a distance of 48 miles from the “PRS” TVOR/DME. The distance from Palermo was requested several times; at about 12.000 ft (about 10 minutes prior to impact with the sea), the captain ordered the senior flight attendant to prepare the passenger cabin for ditching. However, he did not simultaneously notify the controller in contact of Palermo APP of the possibility of ditching the aircraft; indeed, he was still hoping that one or both engines might resume normal running.

Considering that the cause of the dual engine failure was, in fact, shortage of fuel, a detailed analysis of the measures adopted by the crew in the attempt to start the engines and to find out the reason for their failure to start is not deemed pertinent for the purposes of establishing the cause of and contributing factors in the occurrence. Only the aspects deemed pertinent in terms of operations in the passenger cabin and the preparation for and conduct of the ditching phase will be analysed in detail.

2.2.4. Considerations on crew action

Before going into the substance of the crew conduct analysis, the following preliminary remarks are deemed necessary.

Pilot training to handle serious, complex failures or extreme operating conditions is normally carried out on flight simulators. When the simulator is particularly sophisticated, conditions very

²⁶ The FDR records the NH parameters only if they exceed 30% RPM.

close to reality may be simulated, and it is possible to face crews with complex situations stemming from serious failures or malfunctioning in the aircraft systems, or from extreme ambient conditions.

Effective training is provided by a realistic scenario featuring a main failure that triggers logical consequences in the form of malfunctioning in other systems, and which can lower aircraft performance.

Normally, the training methods applied involve the presentation of operating scenarios that never exceed certain bounds of difficulty featuring more than one serious failure, as such conditions are considered extremely unlikely.

After identifying the first failure and starting to apply the relevant check list, the crew detected a loss of thrust in the RH engine followed, shortly after, by the other (LH) engine failure. This emergency situation was not handled correctly, as the checks prescribed in the applicable “BOTH ENGINES FLAME OUT” check list were not performed. However, the particular operating conditions in which the crew found itself must be borne in mind: without information in the cockpit on the distance from Palermo (with the second engine out of action, the DME values are not available), with reduced flight instruments, with a misleading fuel quantity reading, dual engine failure and the prospect of ditching. With dual engine failure, and hence with the electrical generators inoperative, flight instrument availability is limited and the crew has only the stand-by instruments to rely on for the purposes of handling the aircraft.



Photo 85: Detail of stand-by instruments.

The copilot was carrying out the captain's instructions in an almost mechanical fashion. He was often having to break off performance of the prescribed checks to carry out other tasks demanded by the captain, such as making repeated requests for the distance from Palermo and attempting to restart the engines.

In general, therefore, it may be said that the allocation of priorities to the measures to be taken in the cockpit was, at times, influenced more by the perception of a possibly tragic outcome than by observance of the prescribed procedures.

Lack of fuel was not taken into consideration in the handling of the emergency because the FQI reading gave about 1800 kg. Two engines failing simultaneously is, indeed, an extremely unlikely situation. The possibility of fuel contamination being the cause of the engine flame outs would, moreover, not have been taken into consideration, as the flight had already lasted over 50 minutes with no problems whatsoever. The indications provided by the instruments did not make it possible to clarify the causes of the engine flame outs, and much of the crew's attention was devoted to requesting the distance from Palermo airport and, abortive, attempts at re-ignition. The problem on board was thus not restricted to engine loss alone, but extended to the consequent loss of the electrical generators and, hence, of the majority of the flight instruments. Only the stand-by instruments were thus available in the cockpit for handling the aircraft. The stand-by instruments are positioned just to the right of the captain, out of line with his position and, in practice, difficult for the copilot to use (see Photo 85). No other systems and apparatus were available any longer. Contact with Palermo APP, which was constant but failed to measure up to the situation, proved problematic. This latter aspect will be dealt with in detail in the next paragraph 2.7.

As previously stated, the distance from the Palermo "PRS" TVOR/DME was no longer shown on the flight instruments from the time when the second engine shut down. Indeed, as soon as contact had been made with Palermo APP, the first question asked of the traffic controller in contact was the distance from the airport. The TS-LBB pilots asked the same question several times in the course of the emergency.

The situation that had come about in the cockpit was, so to speak, of illogicity with regard to the flight instrument readings, particularly those concerning engine operation. The temperature parameter twice attained values compatible with RH engine re-ignition, although the NH values were not in line with such a situation. Despite having considerable experience on the type of aircraft concerned (the captain had over 5000 flying hours), the crew did not immediately apply the measures prescribed by the procedures, and this has been deemed symptomatic of the specific nature of the failure that had occurred and the situation of stress created in the cockpit, which may primarily be inferred from the cockpit conversations recorded by the CVR.

As soon as Palermo APP reported the distance from the airport (48 NM) for the first time, with the aircraft at an altitude of about 15.000 ft, the captain expressed his doubts in the cockpit as to the possibility of actually landing at Palermo. He in any case attempted, with the assistance of the mechanic/engineer, whom he himself had summoned to the cockpit, to find out what was at the root of the failure and to get a logical explanation for what was happening. In fact, the fuel indicator showed a quantity of 900 kg per tank and both engines had previously been behaving normally, without any sign of anomaly.



Photo 86: Tests on the simulator, note the stand-by instrument panel (illuminated).

In the 16 minutes that elapsed between dual engine failure and ditching, the flight crew was faced with handling a situation regarded as one of the most serious that can occur, characterised by a complete loss of power that gave rise to an electrical emergency and ditching in rough to very rough sea. The fact that these events took place in rapid sequence rendered the situation extremely complex for the pilots. Most of the crew's attention was devoted to the, fruitless, search for the cause of the failure and to attempts to restart the engines. At the same time, the captain also had to handle dealings with the cabin crew, informing it of the situation and instructing it to prepare the passengers and cabin for ditching.

In flight conditions of this kind, the captain in any case had the presence of mind, once he had actually realised that it was impossible to land at Palermo (Palermo APP reported at the altitude of about 4000 ft that the distance was 20 NM), to steer the aircraft in the direction of two vessels, veering away from the previous heading to left and requesting that the vessels in question be alerted so as to facilitate the pinpointing of the aircraft for subsequent rescue purposes.



Figure 34: Final phase of the TS-LBB flight path (FDR data).



Figure 35: Final phase of the TS-LBB flight path (FDR data).

2.3. FINAL PHASE OF FLIGHT AND DITCHING DYNAMICS

The FDR stopped recording with the aircraft at an altitude of 728 ft and Indicated Air Speed of 125 kts. From analysis of relevant data recorded during the previous minute, it has been determined that the aircraft had a descent rate of approximately 700 to 800 ft/min. Therefore in the hypothesis, highly probable, that the pilot maintained the same descent rate until impact, it can be reasonably assumed that approximately one minute has elapsed between FDR recording interruption and the impact with the sea surface. Such hypothesis is verifiable with the comparative analysis of FDR and CVR end of recording timing, with ATC timing (see paragraph 1.11.4.). Regarding the evaluation of parameters needed for determining the dynamics during the final part and that regarding the ditching, it has been necessary to use the results from wreck analysis, CVR data and available witness statements.

The following diagrams show some parameters during the last three minutes of FDR recording.

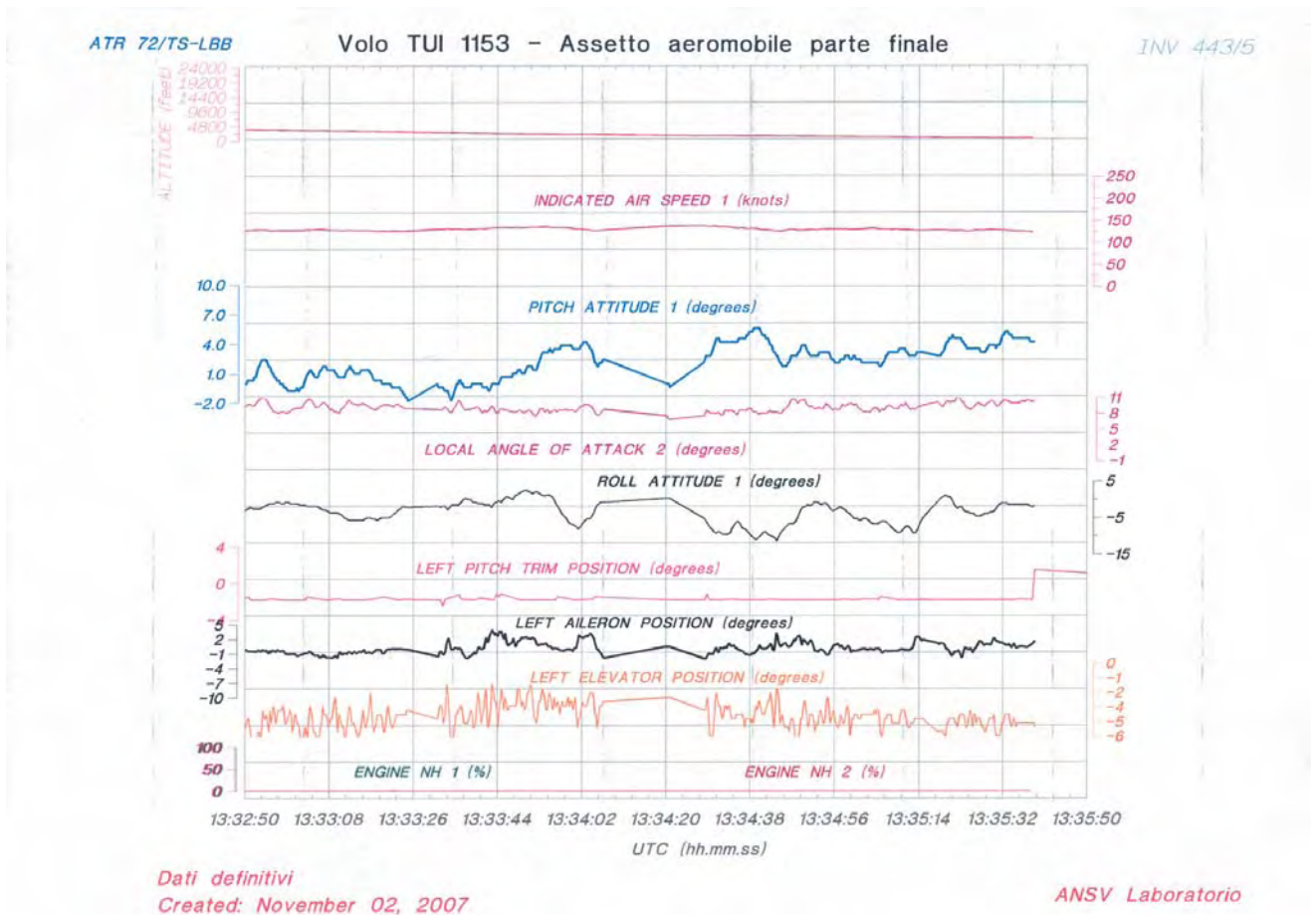

Figure 36: Relevant parameters during final phase.

For faster comprehension, the following table shows numeric values of some parameters concerning the aircraft's attitude at time FDR 14988 (13.35.39 UTC), last recorded value.

FDR time	Altitude	Airspeed	Pitch angle - attitude	AOA - Angle of Attack	Roll Attitude	Heading
14988 sec	728 ft	125 kts	4,2°	10,5°	-1,8°	111°

Table 15: Last relevant parameters recorded by the FDR.

During the twenty seconds before interruption, a slight reduction of the speed has been recorded, with subsequent increase of the angle of attack, indicating a pilot tendency to pull-up when approaching the sea surface. Such tendency also occurred in the final phase, immediately before impact, as in the cockpit was heard a sound ascribable to the pre-stall warning (approaching critical angle of attack), which activated in the flaps configuration at zero, at a AOA value of 11.6°. It is highly probable that also the aircraft attitude (pitch angle) increased since the last recorded value of 4.2°.

It has not been possible to establish with certainty, on the basis of available data, the final pitch angle (attitude), although from analysis of aircraft damage in the rear part and from declarations of some passengers who were occupying the rear of the cabin, it is possible to affirm that the impact occurred, with high probability, with the rear part of the aircraft first, and therefore with an attitude compatible with the optimum 9° pitch.

Some passengers seating in the rear part did hear only a loud boom at the time of impact with the sea surface, immediately followed by seawater entering the passenger cabin.

The senior flight attendant, seated in the rear part of the cabin, beyond the last row of passenger seats, and who suffered fatal injuries, was found at sea still seated in his seat, which had completely uprooted from the cabin floor structure, indicating a possible hard impact mainly localized in the rear part of the aircraft. This represents a further proof of a pitch-up attitude of the aircraft during ditching.

The impact with the sea surface did occur probably with the rear part of the fuselage first; a condition that caused immediate detachment of the tail cone, subsequently recovered still floating. The impact also caused pressure bulkhead failure.

After the first impact, the aircraft suffered a pitching (diving) moment which caused the immersion of the forward part, determining the break-up into three main sections.

Basically, in the final approach phase towards the sea surface, as the aircraft almost reached the

stall condition (stall speed in the estimated load conditions was approximately 104 kts), the attitude was pitch-up and therefore the rear part of the fuselage touched the sea first. Immediately after first contact, the aircraft impacted the sea with the central and forward part of the fuselage, diving into the sea with the nose. Such evidence is confirmed also by the pilots' statements, who affirmed that they were submerged immediately after impact.

The impact of the water against the forward fuselage structure contributed to its structural failure. The LH and RH wings, not showing damage and/or deformation, were not involved in the impact and therefore the roll angle was not remarkably high and it is probable that the aircraft's wings were levelled off during ditching.

However, regarding the ditching direction compared to the waves, on the basis of available information, it is not possible to establish with reasonable certainty the aircraft heading, as FDR data is referable to approximately one minute before impact with the sea surface. The last heading value recorded is 111° and is effectively the same direction as the prevailing wave motion. The crew on the B737 who flew over the wreck approximately 30 minutes after ditching noted that the aircraft's nose was pointing 040°. It is very probable that such difference (111° and 040°) was caused by surface currents and impact.

As shown in previous paragraph 1.18.4.3. during the final phase of approach for ditching, it is extremely important, in order to perform a correct manoeuvre, and minimise eventual damage, to estimate the wind and wave direction as well as the sea conditions. Ditching in the same direction of the waves may cause a condition, after the first impact, where the forward part of the aircraft is submersed by the waves, compromising its structural resistance.

From available evidences, it seems that the flight crew did not consider such aspects, when deciding the optimal ditching direction. It must be said, however, that wave motion and wind direction were not easily determinable; the flight crew, as declared by them and as confirmed by CVR transcriptions and radio communications, tried to ditch as near as possible to two vessels which were navigating in the area, in order to facilitate the successive rescue phase, without fully considering the optimal ditching parameters, in terms of direction compared to the prevailing wave motion.

2.4. OPERATIONS IN PASSENGER CABIN

Communications addressed to the passengers from boarding in Bari until the failure to the two engines were regular. Pre-start safety briefing was also given in the Italian language. As

previously seen, the captain during aircraft descent passing the altitude of 12.000 ft, ordered the senior flight attendant (CA1) to prepare for ditching. At the same time the right engine CLs were feathered and shut-off therefore the propeller stopped turning due to the windmilling effect. As shown in figure 30 diagram, the right engine propeller speed dropped to zero. According to procedures provided, the senior flight attendant ordered the stewardess to prepare the passenger cabin. But the stewardess, as referred to by most passengers, started to become distressed and was looking continuously out of the cabin windows to comprehend the possible problem with the engines. The passengers, seeing the stewardess in panic and in a great state of distress, started to ask themselves what happened and, by looking outside they realised a possible engine problem, as the propellers were not rotating at high speed. As the engines were not running, the right propeller was stopped and the left propeller was rotating slowly; the noise level inside the cabin had in fact noticeably reduced. Passengers were instructed that, due to technical problems, it was necessary to land in Palermo and, as a precaution, they were invited to wear the life jackets. Some passengers referred to have worn the life jacket after seeing the stewardess wearing her own in great distress. The time elapsed from the notice of a possible landing in Palermo and the effective ditching was approximately 10 minutes. Passengers continued to ask for an explanation for what was happening, but they did not receive adequate information, as they declared. Only the senior flight attendant, as referred to by some passengers, was able to help with putting on the life jackets, while the stewardess, greatly in distress by the particular emergency situation, did not perform her duties helping the passengers to put on their life jackets.

It seems that the stewardess was already seated in her seat (in front of the cockpit, looking towards the passengers), when not all passengers were yet seated and prepared for the eventual ditching. The senior flight attendant did supply the necessary support to the passengers to put on their life jackets and using a megaphone, staying upright near his post in the rear part of the cabin, he gave the last instructions to the passengers, until a few moments before impact. In particular he asked not to inflate the life jackets while still inside the cabin, and to remove shoes. On the basis of gathered information, it results that all passengers, during the impact, were wearing their life jackets and had their life belts fastened.

On the other hand, the stewardess declared that she performed passenger assistance operations, according to applicable procedures, paying particular attention to children and people who needed particular help.

The stewardess, during her limited experience, had never faced emergency situations; however, she was qualified and trained to perform operations required by airline's procedures. However,

during the emergency, deficiencies have been found in her behaviour, which of course did not contribute to reassure the passengers but increased panic and uncertainty among passengers. The senior flight attendant performed everything he could do to assist passengers, as much as possible, considering the particular situation. During ditching, he was seated at his post, with safety belt fastened.

2.5. CONSIDERATIONS CONCERNING ATR 72 DITCHING PROCEDURE

The ditching procedure given in ATR 72 manuals, as usually given for other aircraft types, is structured so the crew can normally rely on engine power to perform the final control of parameters fundamental for aircraft flight. As shown in previous Chapter I, paragraph 1.18.4.3., it is in fact required that, in the last 200 ft, to feather the propellers, close the engine fuel feed valves and to operate the fire extinguishers in the engines. This operation should prevent fire breakouts during impact. The ditching manoeuvre is *per se* an emergency manoeuvre and, if performed without engine thrust in the approach phase, it is quite difficult to complete it adequately. It is difficult to choose the optimum heading compared to the wave motion, to set the aircraft in the ideal attitude without losing control, not having the engine thrust available. The structure of procedure shown in FCOM does not take into account the ditching causes. As previously seen, the handling of a ditching without engines running can be more complex than the situation with absence of thrust; it is in fact more difficult to coordinate all elements necessary to perform a good ditching manoeuvre (speed, vertical speed, attitude, direction, moment and point of contact with the sea). Therefore it is advisable to integrate information available in FCOM and QRH emergency procedures, in order to consider also the possibility of ditching without thrust from both engines.

2.6. FAILURE SIMULATION

2.6.1. Preliminary remarks

On the basis of radar data, related to information recorded by the FDR, it has been possible to estimate with a good approximation the aircraft position from Palermo's "PRS" TVOR/DME and therefore from runway 20 threshold, as the VOR station is located very close to it. The following table 16 shows in detail the above mentioned considerations.

Events	FDR Time (UTC) hh.mm.ss.	ATC Time	Altitude	Geographic coordinates	Distance from “PRS”
First engine shutdown (right)	13.19.40	13.21.21	23.000 ft	N 39° 13' 19" E 013° 35' 46"	67,5 NM
Second engine shutdown (left)	13.21.20	13.23.09	~ 21.450 ft	N 39° 07' 40" E 013° 29' 26"	~ 61 NM

Table 16: distance from Palermo Punta Raisi “PRS” at time engines shut down.

2.6.2. Considerations on simulation results

From simulations performed using the ATR calculation software concerning aircraft performance verification (see paragraph 1.16.5.1.), it has been determined that, applying precisely the required procedures in both engine failure conditions, especially with particular reference to the attitude and therefore to the optimum descent rate, the aircraft would have been able to reach Palermo airport.

However, on the basis of simulator tests, it has resulted quite difficult to maintain a correct speed profile, due to possible piloting distractions while following failure management, maintaining, at the same time, an optimum control of the situation. It must also be considered the difficulty of using correctly the information supplied by stand-by instruments.

Above all it must be said that the purpose of simulator session was not to evaluate TS-LBB crew performance, but, as previously stated, to consider the operational scenario and its difficulties. It has also been useful to be able to evaluate other elements such as the sequence of failures and relevant effects. In particular, it has been possible to note how much the aircraft’s piloting difficulty has influenced the deviation from ideal theoretical performance. Furthermore, the crew used on the simulator was composed only of captains at highest professional level, suitably informed before the tests about all aspects of the sessions, including the sequence of failures and relevant causes. However, they gave different performances, sometimes encountering some difficulties, especially maintaining speed.

The sessions, carried out with mission start only a few moments before the sequence of events, have shown that the scenario was characterised by a particularly complex situation, which caused some difficulties to the crew involved. The simulation has been performed in operational conditions more favorable compared to the real scenario, as some important factors were excluded, such as passenger cabin management, the radio dialogue difficulties with Air Traffic Control, the search for failure causes, the deceptive engine restart signals, and in particular the perception of a condition that was leading to a imminent impact.

The fact that one test ended with a ditching and one with a runway landing must be interpreted as a merely fortuitous fact. It is important to acknowledge that high-level professionals, and as said thoroughly informed on the dynamics of the event, encountered some difficulties which sometimes they were not be able to manage.

Tests carried out in the simulator have shown, above all, how it may be difficult for a flight crew to manage aircraft behaviour, in terms of speed and attitude, in serious failure conditions such a double shutdown and subsequent limitations, as occurred on flight TUI 1153.

Furthermore, the tests have emphasised how, from a cockpit resource management point of view, the situation became extremely difficult by the need to perform coordinated actions, which require reading various check lists and executing relevant commands in a limited time.

2.6.3. Approximate estimation of the theoretical range

For an approximate evaluation of the aircraft's range it has been necessary to calculate the true air speed (TAS), using the calibrated air speed (CAS)²⁷, the altitude and the total air temperature (TAT), values based on FDR data. From TAS value, knowing the ground speed (GS), based on radar tracking with some degree of time approximation, it has been possible to estimate the tail wind (Tail wind = GS minus TAS).

The following table shows the calculated values in detail.

²⁷ Although the FDR data relative to speed makes reference to indicated speed, it is already the correct one due to the positioning error of the static port (Calibrated Air Speed – CAS).

Altitude (ft)	Ground Speed (kts)	True Air Speed (kts)	Tail wind (kts) (GS – TAS)
23.000	275	269	6
21.500	250	250	0
21.000	251	242	9
19.400	253	252	1
18.500	264	249	15
18.000	262	236	26
17.000	256	234	22
15.900	245	222	23
14.000	206	182	24
13.000	202	182	20
11.000	204	179	25
10.600	204	178	26
8000	183	158	25
7600	182	160	22
7000	181	158	23
6000	173	145	28
5000	166	146	20
4000	163	138	25
3000	144	130	14
2000	146	129	17
1500	148	137	11
1100	148	134	14
755	144	129	15

Table 17: Tail wind estimation.

From Table 17 it is possible to estimate, during the gliding phase, that the tail wind component was 18 knots ca. as average.

Tail wind values shown in the previous table are compatible and with the same magnitude as the wind values supplied by Italian Air Force Meteorological Office for the relevant quadrant (geographic coordinates included between 38°/39° N and 13°/14° E), for altitudes 24.000 ft,

18.000 ft, 10.000 ft, 5000 ft and approximately 300 ft (950 hPa) and referable to 12.00 UTC, approximately 1 hour 40 minutes before ditching. In particular, the wind direction and speed was variable from 300°/320° with 13-17 kts at 24.000 ft; approximately 180°/ with 13-17 kts at 18.000 ft; higher speeds (> 18-22 kts) at lower altitudes down to 10.000 ft and decreasing down to 13-17 kts at 5000 ft, from 300°-320°.

The following table shows the tail wind estimated on the basis of the above mentioned observations.

Altitude (ft)	Pressure altitude (hPa)	Tail wind (kts)
24.000	400	10
18.000	500	15
10.000	700	> 20
5000	850	< 10
300	1000	< 10

Table 18: Tail wind estimation, Meteorological Office data.

On the basis of available data concerning aircraft performance, with two engines shut down and descending at maximum efficiency speed (speed that allows flying a greater horizontal distance, at a certain difference of altitude), it has been calculated that the ATR 72 is able to fly approximately 2,6 NM every 1000 ft of descent (approximate efficiency 15,80).

Therefore, considering the aircraft's altitude when the engine shut downs occurred (23.000 ft for right engine and 21.450 ft for left engine) and the aircraft's altitude when the crew requested a diversion to Palermo airport (approximately 20.000 ft), with the above mentioned efficiency value it is possible to estimate the ATR 72's range (horizontal distance), if flying at maximum efficiency speed for the whole descent to Palermo. At maximum efficiency attitude, the aircraft's mass does not influence the range, but only the time. Therefore, the higher the mass, the less the time elapsed, but the range remains the same.

In particular, in absence of tail wind, the aircraft could fly a horizontal distance of approximately 56 NM (55.77) from altitude 21.450 ft (corresponding to the aircraft's altitude when the second engine shut down).

Considering also an estimated average constant tail wind of 18 kts, the range would have been equal or slightly greater of the effective distance from Palermo airport.

Considerations

The above mentioned considerations, concerning the aircraft's range in double engine shut down conditions, does not necessarily imply that the aircraft would have been able to land safely on one of the two runways at Palermo airport, even if flying at maximum efficiency speed from immediately after the shut down of both engines.

Actually, the variables that influence both the aircraft's performance and piloting, are numerous, diversified and depend also on the particular operational situation on board. It is extremely difficult to maintain the same speed profile for approximately 15 to 20 minutes in an emergency situation characterised by a failure of both engines and by reduced or total lack of information supplied from the aircraft's instrumentation.

The engines stopped at a distance from Palermo airport (the nearest airport to the aircraft's position, see Attachment "A" concerning the accident zone map which shows the points where the engines shut down), that cannot be considered, due to aircraft's performance, local weather conditions and failure characteristics, quite sure and certain distance to try and perform safe landing at Palermo airport. Reduced aircraft instrumentation indications, due to the double generator failure, limited the crew's possibility of having a positive and effective control of the operational situation. Therefore, any hypothesis about landing on one of Palermo airport's runways in safe conditions is the result of calculations, not taking into account the real technical-operational situation. More likely, the choice was between ditching near the shore or performing a forced landing on solid ground, with consequences that cannot be easily assessable.

2.7. RADIO COMMUNICATIONS

When TS-LBB declared emergency conditions for the first time, the crew was in contact with Rome ACC; after the pilot's request to divert to Palermo, the controller required the aircraft TS-LBB to contact Palermo APP for landing instructions, having not clearly understood the nature of the emergency. As Rome ACC controller would not have been able to assist TS-LBB up to complete landing in Palermo, due to area radar characteristics (it is not possible to assist the aircraft with the same precision as an approach radar, with approach path and relevant runway display), he decided that the best action was to ask TS-LBB to contact Palermo APP for the rest of the flight. The aircraft's emergency conditions were communicated by telephone to Palermo APP, in order to prepare necessary measures for adequately assisting the aircraft.

Examining the evidence available from communications between Palermo APP and the aircraft,

it is possible to affirm that, considering the particular situation onboard TS-LBB, they have been continuous and without interruption, although characterised by some mutual lack of understanding. This has been determined also by phraseology used during the event, which sometimes did not comply with set standards.

Palermo APP controller had difficulties, sometimes, to clearly understand the flight crew's requests in English. Sometimes, the flight crew had not been, in fact, sufficiently clear when making some requests/communications. Furthermore, when an aircraft declares an emergency condition, radio communication shall be reduced down to the essential, in order to allow the pilots performing emergency management actions. The controller of Palermo APP, in trying to best assist the flight crew, several times transmitted information that could have been sent in other moments.

When the aircraft confirmed the emergency declaration, in contact with Palermo APP (approximately at 15.24 UTC), the latter did activate the alarm phase for an aircraft that would have landed at the airport. Palermo APP was not aware (and could not foresee) that the aircraft could perform a ditching. In fact the crew had confirmed that would not be able to reach the airport, only approximately 5 minutes before ditching, at an approximate altitude of 4000 ft. Examining the times related with the failure, if the crew had clearly communicated while in contact with Rome ACC, not to be able to reach Palermo airport, the ditching information would have been received by ATC approximately 10 minutes before actual receipt. It is however presumable that such difference did not have any importance for the successive search and rescue phase. At 13.24, in fact, when TUI 1153 confirmed emergency conditions to Palermo APP, the airport emergency plan was activated, which provides also for the dispatch of naval vessels. The first patrol boat left moorings at 13.31.

2.8. SEARCH AND RESCUE

When the aircraft confirmed the emergency declaration (13.24 UTC) the phases provided by applicable Emergency Plan were activated (“Rules and procedures for aircraft in an emergency and for aircraft rescue in case of accident”). The Emergency Plan states that for air accidents at sea off the airport's shore, within 5 NM, rescue operation shall be regulated by the Civil Defence Plan for Palermo area “Piano della Protezione Civile-Ufficio territoriale del governo di Palermo” (issued July 2003).

In the case under examination, as the aircraft ditched off Palermo at a distance greater than 5 NM, the applicable plan was the one relevant to the National Plan for search and rescue at sea “Piano S.A.R. Marittimo Nazionale”, approved on November 25th 1996 by the Minister of Transport and Navigation (now Minister of Transport) in charge at the time (IMRCC/001). Within the limitations of the checks performed, it is possible to affirm that all operations scheduled and actuated by involved bodies was performed according to the applicable airport emergency plan. Such operations have been realised according to congruent times and methods and relevant to requirements of the above National Plan for search and rescue at sea, IMRCC/001.

After the event, the Headquarters of the Capitanerie di Porto (Comando Generale), did however undertake actions concerning planning and realisation of rescue activities at sea, in case of accidents. The SAR 026 Directive, issued on December 19th, 2005, emphasises some of the most significant technical-operational aspects of planning the above mentioned rescue at sea.

In particular, the Headquarters of CP has already undertaken some initiatives to reconsider the situation of naval vessels specifically equipped for rescue at sea, in order to optimise both the distribution of existing resources, and the procurement of new craft.

Some activities has also been initiated in order to implement/install telephone connections between MRCC and the 4 area control centres (Milano, Padova, Roma and Brindisi ACC).

2.9. FUEL SYSTEM AND FQI

2.9.1. Effects of mounting an ATR 42 type FQI on an ATR 72 aircraft

Experimental tests carried out after the event shown that the fuel quantity indicated by an ATR 42 type FQI installed on an ATR 72 is greater than the fuel effectively present, and follows a linear variation, with a slope higher than 50%. In particular, extrapolating data down to a value of 0 kg, the ATR 42 type FQI indication is approximately 1800 kg, which corresponds to the quantity communicated by the TS-LBB crew to the ATC who was in contact before ditching.

For zero fuel on board, the ATR 42 instrument shows a presence of 900 kg in each tank (so the total fuel quantity on board shown by FQI is equal to, or greater than 1800 kg). Basically, the quantity shown by TS-LBB’s FQI before ditching was 1800 kg (900 kg per tank) and the fuel quantity effectively present was 0 kg. This circumstance was the cause of uncontrolled shut down of both engines.



Photo 87: FQI installed onboard TS-LBB, taken immediately after wreckage recovery.

2.9.2. Other cases of incorrect FQI replacement

As said in previous paragraphs, following the first safety recommendations issued by ANSV after the event, EASA has approved Emergency Airworthiness Directive (Ref. GSAC/T 50/05-AD N° UF-2005-160 dated 8 September 2005), issued by France's DGAC, which prescribed a check, one-off (*una tantum*), on ATR 42 and ATR 72 aircraft, in order to verify the correct installation of fuel indicators. ATR manufacturer, in turn, issued an AOM 42-72/2005/08, with which it emphasised to all operators the correct procedure application, as well as parts P/N identification, in compliance with information shown in applicable nomenclature catalogues or illustrated parts catalogues (IPC), in order to avoid the installation of unsuitable components.

In spite of the issue of such documentation, on March 18th, 2006, another case of incorrect FQI replacement occurred by a German operator, whose fleet included ATR 42 and ATR 72 aircraft. The component had been mounted on an ATR 72-212A, before a flight, in an airport which is not a base of the operator.

On the basis of the technical investigation conducted by German investigation authority (BFU), it was determined that the mechanic in forward base had noticed the different FQI Part Numbers (P/N). P/N of the removed FQI: 749-759. P/N of the FQI to be installed: 749-757. He therefore asked - using the telephone line - to a technician at the Home Base and received the answer that

the two P/Ns were interchangeable. In retrospect it was determined that the two people had spoken about two different replacement parts. Whereas the mechanic talked about the FQI the colleague at the Home Base spoke of the Fuel Probes in the fuel tanks. These are indeed interchangeable whereas the FQIs are not.

The flight crew, during pre-flight checks, compared the quantity of fuel loaded with the fuel already present in the tanks, using information supplied by FQI and noted an incongruence between the indicated quantity and the quantity shown in the aircraft's documentation. The FQI, in fact, showed a fuel quantity of approximately 1800 kg greater than the quantity effectively present and shown in technical documentation supplied. The following check, performed by technicians with graduated dripsticks, confirmed such discrepancy. Only at this point the technicians realised the installation error of the FQI. In particular, instead of installing P/N 749-759, suitable for the ATR 72, P/N 749-757 had been installed, suitable only for the ATR 42.

The Job Instruction Card (JIC) applicable on the day of the event (Attachment "C"), concerning FQI replacement, did not require a congruence check between FQI indications and data shown in the aircraft's documentation and/or checking that FQI indications before and after replacement remained constant. It required only to check, after installation, through the system test, the illumination of LO LVL light and of all LEDs present on the two FQI displays. The JIC did not require a check of the instrument's correct indication, which can be performed by measuring with the dripsticks inserted in the lower zone of the LH and RH wings.

In April 2006 the manufacturer emended the relevant JIC, requiring a set of actions aimed to check congruence of FQI indications before and after replacement.

Following the above mentioned event, the BFU issued, on October 25th, 2006, a specific recommendation to EASA (Attachment "D"), which basically mirrors the recommendation previously issued by ANSV (ANSV-7/443-05/2/A/05), concerning the possibility of providing an installation modification in order to prevent installing a FQI designed for the ATR 42 on an ATR 72.

EASA replied to such recommendation on April 10th, 2007, (Attachment "D") affirming that, given the new case similar to the one which occurred with TS-LBB, a risk evaluation would have been performed by means of specific contacts with the manufacturer. This in order to evaluate the opportunity and/or possibility of an installation modification for FQIs on ATR 42 and ATR 72 fleets.

Considerations

At present there are no general regulations that impose manufacturers to provide installation modifications for components with same functions and ostensibly similar from a construction point of view, but with different performance, which may be installed on various types/versions of aircraft but belonging to the same family (e.g. Boeing B737-200, -400 and -800; Airbus A319, A320, A321, ATR 42 and ATR 72; etc.).

It is therefore desirable that the two world largest aviation regulation organizations, FAA and EASA, carry out studies aimed to define guidelines and/or issue regulatory requirements, concerning the possibility of providing suitable installation modifications on the aircraft or on the component itself, in order to avoid that components with same functions and ostensibly similar but with different performance, could be installed in error.

2.9.3. Considerations regarding FQI's identifying Part Number

The maintenance technician, when verifying the availability of a spare FQI, used the P/N shown in the IPC, as required by normal maintenance procedures.

In particular, he found three Part Numbers corresponding to the FQI to be replaced, each of them installable on the ATR 72:

- 748-681-2;
- 749-160;
- 749-759.

As detailed in the previous paragraph 1.1.2., no FQI identified by one of the three applicable P/N codes was recognised by the spares management system. Such P/N codes, in fact, showed a dash after the first three digits, while in the spares management database the FQI's P/N was entered without the dash after the first three digits (P/N 748681-2). Such P/N was the same as the one shown on corresponding JAA Form One (declaration of readmission in service of aviation components). The spares management software used by the operator (®AMASIS) considered the dash after the first three digits as a digit, therefore the search had a negative result. If the technician had searched without inserting the dash after the first three digits, he would have certainly seen the information concerning P/N 748681-2 on the screen.

The FQI manufacturer stated that the dash placed after the first three digits was removed in 1992, for Information Technology (IT) reasons. The same manufacturer has house regulation governing Part Number allocation methods, however, the regulation itself has not always been applied

systematically.

On the basis of available information, at present, there is no uniform international regulation concerning P/N assignment methods for components and/or instruments used in aviation.

It is therefore desirable that the two world largest aviation regulation organizations, FAA and EASA, carry out studies aimed at defining guidelines and/or issue regulatory requirements, concerning P/N assignment methods for aviation components.

2.10. ENGINE INVESTIGATIONS

Technical assessments performed on the engines has excluded, beyond a reasonable doubt, that engine shut down can be traceable to a failure in the engine system.

The section of steel cable found wound on the right shaft probably belonged to the moving surfaces' control cables that run along the fuselage. Presumably, during impact and fuselage failure, one of these cables broke free and accidentally entangled on the propeller shaft.

The analysis of malfunction codes recorded by EECs did not show any noticeable failures related to the event.

Installation non-conformities found on the two engines, show a deficient maintenance quality level, as performed by the operator at the time of the accident.

During a visit made to the operator's premises, in November 2005, it was noted that the same types of non-conformity were found on engines of an aircraft on the ramp, confirming a low quality standard of maintenance performed on the engines.

Installation non-conformities have been found on both engines of TS-LBB (piping and electric wiring clamps missing, use of incorrect connection pieces), although not being so important as to compromise the engines' operation, show potential deficiencies regarding engine maintenance organizations that have worked on those engines.

2.11. OPERATOR'S MAINTENANCE PROCEDURES

On the basis of collected evidence, concerning operator's maintenance organization, technical-management deficiencies have been found. In particular, there was an inadequate spares configuration management (inaccuracy of data fed into the ®AMASIS spare parts management system and lack of effective monitoring of the system itself). More specifically, it is noteworthy to highlight the following deficiencies.

- Organizational discrepancies in the performance and recording of maintenance work carried out on the engines.
- Some maintenance job cards did not state the revision of the applicable engine manufacturer documentation.
- Procedures for unscheduled maintenance intervention off-base were not reported in the Maintenance Manual Control, in terms of indication of personnel responsible, preventive planning and verification of adequacy of the base.
- The maintenance personnel failed sometimes to demonstrate an ability to interpret the engine manufacturer's documentation for the purposes of establishing the acceptability of components with different P/Ns.

The spares management system also did not appear to be validated in its contents. In fact, one of the factors that contributed to the event was that the P/N of the FQI installed erroneously was considered to be interchangeable/applicable to the ATR 72 version.

In conclusion, maintenance and organization standards of the operator have not been considered satisfactory for an adequate aircraft management.

After the event, the operator undertook a series of actions in order to eliminate maintenance and organization deficiencies. In particular, with the support of an foreign institution expert in certification, the operator performed a series of structural and organizational changes which allowed achieving, between the end of 2005 and the beginning of 2006, a quality system certification according to ISO 9001 standard for "Marketing of national and international scheduled and charter passenger flights".

Some of the most interesting aspects are shown hereinafter.

The operator started the human factor (HF) training for the whole staff (maintenance technicians, engineers and administration personnel). Flight crew (pilots and flight attendants) had already followed, before the event, HF programs.

Refresher programs have been defined and implemented for the whole staff of the Technical Department concerning company procedures and line maintenance procedures, with particular reference to the engines.

A new format for the technical part of the logbook (TLB) and relevant filling instruction, according to JAR-OPS 1 standards has been compiled; in particular, the new TLB includes the part concerning refuelling and post-flight residual fuel registration, with relevant certifications.

The format and instructions are similar to those used by JAR-OPS certified operators in European countries.

The operator has also verified the correctness of information entered in the spare management system (®AMASIS) regarding Part Numbers of usable parts and their interchangeability. A person responsible for data entering has been appointed.

Subsequently a monitoring program has been defined, between Italian ENAC and Tunisian DGAC, for technical-operational activities and for the respect of safety standards, to be carried out through joint audits.

2.12. CONSIDERATIONS CONCERNING THE RELATION BETWEEN JUDICIAL AUTHORITY INQUIRY AND ANSV TECHNICAL INVESTIGATION

Considerations shown in Chapter I, paragraph 1.18.1., underline the limits of the technical investigation, also in Italy, in presence of the possible simultaneous judicial authority inquiry which, unlike the technical investigation, is carried out based on criminal procedure rules. This issue is well-known at international level and it exists in all those States with law similar to the Italian legislation. Such limits have been precisely underlined also by ICAO during the audit to the Italian civil aviation system, carried out in May 2006.

In particular, referring to the accident to TS-LBB ATR 72, attention is drawn to the following considerations.

- a) Flight recorders (FDR and CVR) of the aircraft involved in the accident were opened, read and decoded 10 days after recovery. In particular, due to the limits imposed by competent judicial authority according to the criminal procedure code, it has not been possible for ANSV to perform above mentioned operations immediately after the equipment becomes available, as it should happen and as it normally happens worldwide during technical investigations. The delay in reading data contained in flight recorders of an aircraft may compromise the development of an efficient and rapid prevention action, in the interest of flight safety and therefore the safeguard of public safety. It can also compromise the reading result of data contained in the devices, due to the possibility of damage to the relevant medium on which the information is recorded, especially if the devices are not correctly preserved. In general it is noted that, according to Italian legislation, the judicial authority – in case of inquiries for

different purposes on an event which is also subject to ANSV technical investigation – may prevent or delay the acquisition, by ANSV, of elements fundamental for technical investigation development, with serious consequences in terms of prevention in the interests of flight safety.

Therefore the necessary legislative initiatives should be taken aimed at ensuring the possibility for ANSV, even in the case of a pending judicial authority inquiry, to have immediate and unconditional access to all elements (*in primis*, information contained in aircraft flight recorders) necessary for carrying out the technical investigation.

- b) During technical investigation it has not been possible for ANSV to rapidly ensure to representatives and relevant consultants of foreign states appointed for technical investigations, some of their rights according to provisions stated in Annex 13 of International Civil Aviation Convention, because of the limits imposed by the competent judicial authority according to the current legislation in force (criminal law).

Therefore it is desirable to take necessary legislative initiatives aimed to ensure, in Italy, the rights of accredited representatives and relevant consultants of foreign states appointed for technical investigations, according to provisions stated in Annex 13 of International Civil Aviation Convention, also in the presence of a judicial authority inquiry.

- c) The competent judicial authority, on the basis of the legislation in force, has made available to the parties the contents of the CVR installed on the aircraft involved in the accident. In the afternoon of the day in which that content became available to the parties, some press agencies – it is not known how – were also in its possession, making it available to the public domain, in written and audio format. Some of the dialogues recorded by the CVR and made available to the public domain were not relevant for reconstructing the dynamics of the event. The unconditional circulation of CVR contents conflicts with provisions 5.12 and 5.12.1 in Annex 13 of the International Civil Aviation Convention and can have serious negative consequences regarding prevention, thus preventing avoidance of other accidents.

In general, observations made for safeguarding CVR contents may also concern radio recordings of communications between aircraft, between aircraft and ATC, as well as recordings of telephone calls made between ATC centres.

Therefore, the adoption of necessary legislative initiatives to change the Italian code is encouraged, in order to make it consistent with provisions 5.12 and 5.12.1. in Annex 13 of

the International Civil Aviation Convention. In particular, such initiatives should aim to establish the principle that recordings contained in the CVR, recordings concerning communications between aircraft and between aircraft and ATC centres, as well as recordings of telephone calls between ATC centres, can be used in judicial proceedings, limited to the parts that assume particular relevance for reconstructing the event, while other parts not relevant for analysis of the event shall not be made available, remaining permanently confidential.

2.13. ANALYSIS ACCORDING TO JAMES REASON’S ORGANIZATIONAL ACCIDENT MODEL

2.13.1. Introduction

The accident under examination, as most aviation accidents, was determined by a series of events linked to one another, which caused the final ditching.

It should be tried to analyse the event using the Reason²⁸ model, widely used in case of aircraft accidents and provided also as an analysis instrument in documentation ICAO Doc. 9683 (Human Factors Training Manual) and in “Human Factor Digest No.7 - ICAO Circular 240-AN/144” (Investigation of Human Factors in Accidents and Incidents).

This model (known as “organizational accident”) divides the protection barriers that the system may use to defend safety into five levels (further details are available in the above mentioned ICAO documents).

Using this model it is easier to highlight how errors or omissions (*Active failures*) committed by front line staff (pilots, air traffic controllers, maintenance staff, etc.) can become the triggering element of an accident, if combined with certain pre-existing factors and conditions (*Latent failures*).

In fact, such latent conditions decrease the safety level of the system, making it vulnerable and no longer error-proof. Such conditions, considered individually, do not constitute a high risk. Their potentially harmful consequences may remain concealed for a long time, only suddenly emerging when combined with active failures, such as failures and/or omissions/errors by staff directly involved in the execution of a particular duty.

²⁸ Professor James Reason of Manchester University, United Kingdom.

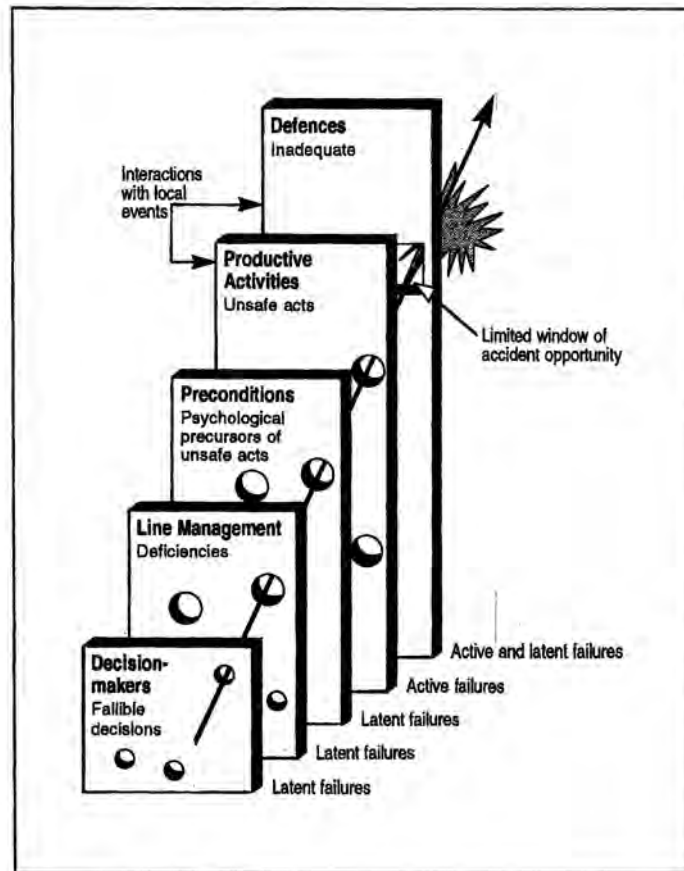

Figure 37: Reason's model.

Through the analysis performed according to this model, it is possible to identify the causes of an accident, considering its “organizational” character.

Therefore, according to Reason's model, the error of the flight crew or of another operator, whose action determines an accident, is only the last link of a chain of situations which have originated on a higher level of the system.

2.13.2. Accident origin and analysis

The accident originated from the incorrect replacement of the fuel quantity indicator (FQI), performed the day before. However, this should not be considered the main cause.

The event has been analysed not only as a human error (performed by mechanics/technicians who replaced the FQI not searching for the correct item, and by the aircraft's crew who, although

they had the possibility of notice the incorrect replacement, did not perform any corrective action), but also as a series of organizational errors.

All people involved in the event did not receive sufficient aid from the system in which they were operating to avoid the so-called fatal error.

The error that caused the accident has been determined by errors carried out by so-called “*front-line*” operators, but such errors occurred in a critical operational situation which, if it has not been so, maybe would have prevented the accident itself.

The aetiology of the event shown in fact the presence of multiple factors: errors committed by ground mechanics when searching for and correctly identifying the fuel indicator; errors committed by the flight crew; non-respect of various operational procedures and lack of adequate control by responsible persons of various sectors of the operator’s organization; lack of an adequate quality control system; lack of accuracy of data entered in the spares management system database; mechanics not adequately trained on use and procedures for spares search with the spares management system; deficiencies in maintenance and configuration control for the fleet’s aircraft and procedural deficiencies in technical management and maintenance of the aircraft; low qualitative standard for maintenance operations; inadequate surveillance of the operator by the competent Tunisian authority; lack of Flight Data Monitoring system; lack of adequate Safety Management System.

From the above mentioned considerations, it is possible to affirm that in the event two types of errors (failures) occurred: active and latent failures.

Active failures, which had triggered the accident, are those committed both by ground mechanics/technicians the day before the event while searching for and replacing the fuel quantity indicator, and by the crew who did not verify and fully and accurately complete the aircraft’s documentation, through which it would have been possible to perceive an anomalous situation regarding the quantity of fuel onboard.

Latent failures, however, remained concealed, latent in the operator’s organizational system until, some active errors (by mechanics and pilots) were made, overcoming the system’s defence barriers, causing the accident.

Some of the system’s active and latent errors are analysed in detail hereinafter.

Active failures

- *Line mechanics/technicians.*

- Incorrect procedure performed while replacing the fuel quantity indicator (lack of checks on the applicability of item P/N 749-158 for ATR 72 aircraft, both before and after its replacement).

Incorrect use of maintenance documentation supplied with the aircraft. The technician who search for the component to replace did not check its compatibility by consulting, as required, the nomenclature catalogue (known also as Illustrated Parts Catalogue, IPC). In fact, a basic rule for those who work in the maintenance field is to install only items shown in the IPC. Any discrepancy shall be reported to the engineering department (Technical Office or other denomination) which shall clear any doubt, consulting the official technical documentation supplied by the aircraft's manufacturer, and if necessary contacting the manufacturer through its customer service. The technician who installed the faulty FQI did not also check the IPC compatibility before and after installing it on the aircraft.

- Incorrect search method for the FQI to be installed, using the aircraft management and spares information system.
- Ground refuelling before leaving Tunis, performed without verifying that the loaded quantity was congruent with the quantity required as Block Fuel by the captain.

- *Flight crew.*

- Operational procedures have not been followed regarding compilation/updating the so-called operational flight plan.
- Airline procedures, which require compilation of the Performance Record All Aircraft (logbook) before each flight, indicating refuelling quantities and fuel consumption, had not been followed.
- During the ferry flight from Tunis to Bari, the crew did not notice that they burned (according to FQI indications) approximately 37% more fuel compared to the planned consumption of 1100 kg, as shown on the flight's load sheet. A reading of Fuel Used (FU) instruments would have shown fuel consumption data (950 kg) compatible with planned consumption but

contrasting with information supplied by the FQI. Such a difference should have caused a suspicion in the crew of a possible failure (anomalous fuel quantity indication) with subsequent checks.

- Inadequate flight preparation.

The crew did not carefully check the reasons for lack of a refuelling slip from 790 kg to 3100 kg and relied on information supplied by the Flight Dispatcher. Actually such a slip did not exist, as the difference in fuel indication was caused by the incorrect replacement of the FQI and not by an actual refuelling. A careful search for the refuelling slip, also through the company that performed the refuelling, would have induced the crew to think that the fuel quantity indication was not reliable and therefore to carry out other checks; furthermore, the flight captain after having required refuelling up to 3800 kg total on receipt of the refuelling slip, did not note that, instead of 700 kg (corresponding to approximately 900 litres) which should have been received, only 465 kg (600 litres) had been effectively received.

Latent failures

- Inadequate checks by the competent office of the operator that flight crew were respecting operational procedures (most flight crews did not compile the operational flight plans during each flight and a periodic check was not ensured).
- Inaccuracy of the information entered in the aircraft management and spares information system and the absence of an effective control of the system itself.
- Inadequate spares configuration management.
- Inadequate training for aircraft management and spares information system use, and absence of a responsible person appointed for managing the system itself.

None of the system maintenance technicians had received formal training by the company who designed and created the system. The TS-LBB operator was not included in the customer list for the spare and configuration management system. Actually the system was managed by another Tunisian airline that used it to manage the spares for its own fleet, which did not include at the time of the event ATR-type aircraft.

- Inadequate procedures for aircraft maintenance and technical management; this caused the determination of roles and responsibilities of the staff involved in various technical-maintenance activities to be confused and not identifiable.

- Maintenance and organization standards of the operator unsatisfactory for an adequate aircraft management.
- Absence of a Quality Assurance System.
- Different nomenclature used by the manufacturer in the aircraft's maintenance manual, compared with nomenclature used by the operator and shown in the aircraft management and spares information system.
- Installation characteristics of fuel quantity indicators (FQI) for ATR 42 and ATR 72 which made it possible to install an ATR 42 type FQI in an ATR 72, and *viceversa*.
- Inadequate certification legislation currently in force "EASA Certification Specification 25 - Large Aeroplanes" (replaces previous JAR-25), applicable to ATR 42 and ATR 72 aircraft type, which does not specifically require the installation of a low level warning system for the fuel system, independent from the fuel quantity indication system.

If the aircraft was equipped with a low fuel level warning system, independent from the indication system, during the previous ferry flight from Tunis to Bari the low level warning light would have illuminated shortly before landing and would have certainly alerted the crew, as the quantity indicated was noticeably above foreseen fix limit (160 kg per tank).

- Absence of a Flight Data Monitoring system. This was not compulsory, according to operator's national regulations. It was not a *standard* for the Annex 6 ICAO, but it was only a recommendation.
- Absence of a Safety Management System. This was not compulsory, according to operator's national regulations and international requirements at the time of the accident.
- Inadequate surveillance of the operator by the competent Tunisian authority.

The analysis of some maintenance evidence, even if not strictly connected with the accident, shows that some deficiencies as far as safety culture was concerned. In particular, the spares management system did not appear to be validated in its contents and the data were not accurate. Furthermore, the operator did not have an Operations manual (GEN-OPS) approved by the competent Tunisian DGAC. The one in use was that applicable to another airline, which did not have in its fleet ATR 72 and ATR 42 type aircraft. An approved Operations manual for an airline by the State of the Operator's competent authority is an essential requisite for the issuing of an Air Operator Certificate (AOC), as prescribed by the international rules (Annex 6 ICAO, Charter 4, Flight Operations). After the accident the

operator prepared an Operations manual applicable to their operation and it was then approved by the Tunisian DGAC. It has to be pointed out that the accident prevention and flight safety programme should be documented in a company's operations manual.

- Inadequate manufacturer's control procedures, concerning FQI replacement.

Maintenance instructions issued by the aircraft's manufacturer concerning FQI replacement did not require comparison of fuel quantity indications from the new component with the one to be replaced and/or performing a check with dripsticks located under each LH and RH wing, on the respective tank.

CHAPTER III

CONCLUSIONS

3. CONCLUSIONS

3.1. EVIDENCE

The aircraft was efficient and had undergone the required periodic checks.

Aircraft's airworthiness certificates was valid at the time of the accident.

Flight crew and cabin crew were in possession of licences and certifications required by applicable legislation.

Weather conditions were in no way critical. Sea conditions offshore from Palermo were characterised by a northwesterly (NW) fresh breeze, force 4, sea from NW 3-4 (Douglas scale indexes), wave direction southeast.

Technical assessments performed on the engines excluded, beyond a reasonable doubt, that engine shut down can be traceable to a failure in the engine system. The examination of all components on both engines did not show failures or breakage which may be related to the shutdown which occurred during the flight.

The immediate cause of engines shutdown was the lack of fuel supply (fuel exhaustion).

The quantity of fuel effectively present onboard after the uncontrolled engine shutdowns was 0 kg, although the quantity shown by the FQI was, erroneously, 1800 kg (900 kg for left wing tank and 900 kg for right wing tank). Experimental tests confirmed that in absence of fuel in ATR 72 tanks, the fuel quantity indicated by the ATR 42 type FQI is approximately 1800 kg.

Tests have shown that if an ATR 42 type FQI is installed on an ATR 72, a fuel quantity greater than the effective fuel present is shown on the cockpit.

Examining the documentation acquired by ANSV and inspecting the wreckage, it has been found that the Fuel Quantity Indicator (FQI) showing the fuel quantity in wing tanks installed

on the TS-LBB ATR 72 cockpit, was of the ATR 42 type (P/N 749-158, S/N 238).

The FQI had been replaced the day before the event, after the inefficiency of the fuel quantity indicator was noticed by the captain. The maintenance technician who verified availability of a spare FQI, used the P/N shown in the IPC, as required by normal maintenance procedures. However, no FQI identified by one of the three applicable P/N codes was recognized by the aircraft management and spares information system (®AMASIS). Such P/N codes, in fact, showed a dash after the first three digits, while in the ®AMASIS database the FQI's P/N was entered without the dash after the first three digits (P/N 748681-2).

In the operator's spares information system database, the P/N of the FQI applicable for ATR 72 aircraft has not been entered as shown in the IPC. The information concerning applicability in the operator's spares information system database was erroneous, as the P/N 749-158 identifies an FQI applicable only to ATR 42 aircraft and not also to ATR 72 aircraft. The technician who search for the component to replace did not check its compatibility by consulting, as required, the nomenclature catalogue (known also as Illustrated Parts Catalogue – IPC). The technician who replaced the FQI did not also check, through the IPC, the applicability of item P/N 749-158 for the ATR 72, neither before, nor after the replacement.

The FQI replacement procedure, as stated in the ATR manufacturer maintenance manual applicable at the time, did not require a manual check, using the dripsticks, of the effective fuel quantity present in each tank and relevant comparison with the value shown by the FQI.

From both engines fuel flow data, it has been possible to establish that, when taking off from Bari, the real fuel quantity was approximately 540 kg. However, the quantity indicated by the FQI was approximately 2700 kg.

Approximately 49,50 minutes after take off at Bari, the right engine stopped, while the left engine stopped 100 seconds later.

The crew, after having identified the first failure and started applying the relevant check list, acknowledged a loss of thrust from the right engine, shortly followed by the failure on the other engine (left). This emergency situation was not managed correctly, as the controls listed in the applicable “BOTH ENGINES FLAME OUT” check list were not carried out. However, it must be considered the particular operational conditions in which the crew was operating: without information concerning the distance from Palermo (with the second engine stopped, DME values are not available), with reduced instrumentation, with a misleading fuel quantity reading, a double engine failure and risk of ditching. With dual engine failure, and hence with the

electrical generators inoperative, flight instrument availability is limited and the crew has only the stand-by instruments to rely on for the purposes of handling the aircraft.

Following the second engine failure the captain called for no procedure to be implemented. The one that should have been applied was “BOTH ENGINES FLAME OUT.” In particular, it prescribed positioning the CLs on FTR (feather) and SO (Shut Off) so as to feather the propellers and shut off the fuel flow. The unfeathered propellers created considerable drag to aircraft headway, and this undoubtedly contributed to its losing altitude faster than it would have done with the propellers feathered and, consequently, travelling a shorter horizontal distance.

The analysis of cockpit conversations deduced by listening to the CVR, together with FDR data regarding aircraft’s altitude and speed parameters, as well as information released by the flight crew, allowed the reconstruction of the actions performed by the crew from the first failure up to the final phase of ditching.

The situation in the cockpit was characterised by understandable concern, in particular after ATC communicated for the first time the distance from Palermo. In fact the aircraft was flying at approximately 15.000 ft at a distance of 48 NM from “PRS” TVOR/DME. The crew requested many times the distance from Palermo and, at approximately 12.000 ft (about 10 minutes before impact with the sea), the captain ordered the senior flight attendant to prepare the cabin for possible ditching. However the captain did not communicate to the controller in contact (Palermo APP) the possibility of ditching; he still hoped that one or both engines would start again. When managing the emergency situation the possibility of lack of fuel was not taken into consideration, as the FQI indicated approximately 1800 kg. The simultaneous failure of both engines is in fact an extremely improbable condition. The condition of contaminated fuel, which may have caused the engine shutdowns was not taken into consideration as the aircraft had been flying for 50 minutes without any problem. Indications supplied by the instruments did not allow clarification of the cause of engine shutdown, and most of the flight crew’s attention was paid to the request for the distance to Palermo airport and to attempting to restart the engines.

The FDR stopped recording with the aircraft at altitude 728 ft and airspeed 125 kts. From analysis of relevant data recorded during the previous minute, it has been determined that the aircraft had a descent rate of approximately 700-800 ft/min.

The sea wave conditions and wind direction were not easily determinable by the flight crew. The captain tried to ditch as near as possible to two boats that were in the area, in order to ease the successive rescue phase.

Regarding the ditching direction compared to the wave direction, on the basis of available information, it is not possible to establish with reasonable certainty the aircraft's heading, as FDR data is referable to approximately one minute before impact with the sea surface. The last heading value recorded is 111° and is effectively the same direction as the prevailing wave motion. The crew on the B737 who flew over the wreck approximately 30 minutes after the ditching noted that the aircraft's heading was pointing 040°. It is extremely possible that such a heading difference (111° and 040°) could have been caused by surface currents and impact.

It has not be possible to establish with certainty, on the basis of available data, the final pitch angle (attitude), although from analysis of aircraft damage in the tail section and from statements of some passengers who were occupying the rear part of the cabin, it is possible to affirm that the impact with the sea occurred, with high probability, with the rear part of the aircraft first, and therefore with an attitude compatible with the optimum 9° pitch.

The impact with the sea surface probably did occur with the rear part of the fuselage first, causing immediate detachment of the tail cone, subsequently recovered while still floating. The impact also caused pressure bulkhead failure. After the first impact, the aircraft suffered a pitching (diving) moment which caused the immersion of the forward part of the fuselage. This caused its breakup into three main sections. The forward part (fuselage part and cockpit) and the rear part (fuselage part and tail section) sank after approximately 45-50 minutes after ditching. The depth of sea in the area is approximately 1500 metres. Therefore the aircraft's flight recorders located in the tail section were not accessible.

The captain and the first officer suffer serious injuries while the airline mechanic/engineer, who was present in the cockpit, suffered fatal injuries. Both cabin crew members, when ditching, were seated in their seats. In particular, the senior flight attendant, seated in the rear of the passenger cabin, suffered fatal injuries, while the stewardess, seated in the forward part of the cabin, facing the cabin, suffered serious injuries.

All passengers on the aircraft, with the exception of the operator's airline engineer, whose ground duty was to assist the flight crew in the preparation of the aircraft, were of Italian nationality (34). Among them, 14 suffered fatal injuries and 20 of them suffered serious to minor injury. Most of the passengers who suffered fatal injuries were seated in the front right part of the cabin, near the cabin failure lines.

Wreckage localization and recovery operations (including the three bodies initially missing) were coordinated by the Italian Navy; they started on August 9th, 2005 and ended on September 2nd, 2005. The position of the wreckage at the bottom of the sea call for a distance from the coast

line within national waters, as determined by Italian Navy and Ministry of Transport-Capitaneria di Porto di Palermo.

The LH and RH wings appeared intact and no signs of impact with the sea surface and/or evident damage were noted. The central section of the fuselage was broken along two breakage lines and did not present evidence of fatigue and/or corrosion.

From simulations performed using the ATR calculation software regarding aircraft performance check, it has been determined from a theoretical point of view that, applying the required procedures in both engines failure conditions, especially with particular reference to the maximum efficiency speed, the aircraft would have been able to reach Palermo airport. However, on the basis of simulator tests, it has proved quite difficult to maintain a correct speed profile, due to possible piloting distractions while following failure management and maintaining a constant control of the situation. It must also be taken into consideration the difficulty of correctly using the information supplied by the remaining instruments available.

The flight crew, in the 16 minutes ca. that elapsed between shut down of both engines and ditching, had to manage a situation considered as one of the most serious that may occur, characterized by a complete loss of power with subsequent electrical emergency and ditching in rough sea. In such flight conditions, the captain had the determination, once he realized that it was impossible to land at Palermo (at an approximate altitude of 4000 ft Palermo communicated that the distance was 20 NM), to direct the aircraft towards two boats, deviating left from the previous heading and requesting these boats to be informed in order to facilitate the aircraft identification for the subsequent rescue operations.

The engines stopped at a distance from Palermo airport (the nearest airport to the aircraft's position) that cannot be considered, due to aircraft's performance, local weather conditions and failure characteristics, quite sure and certain to try and perform safe landing at Palermo airport. Reduced aircraft instrumentation indications, due to the double generator failure, limited the crew's possibility of having a positive and effective control of the operational situation.

Maintenance and organization standards of the operator, at the time of the event, were not considered satisfactory for an adequate aircraft management. After the event, the operator undertook a series of actions in order to eliminate maintenance and organization deficiencies. In particular, with the support of an foreign institution expert in certification, the operator performed a series of structural and organizational changes which allowed achieving, between the end of 2005 and the beginning of 2006, a quality system certification according to ISO 9001

standard for “Marketing of national and international scheduled and charter passenger flights”. This certification process started in 2004.

During technical investigation it has not been possible for ANSV to rapidly ensure to representatives and relevant consultants of foreign states appointed for technical investigations, some of their rights according to provisions stated in Annex 13 of International Civil Aviation Convention, due to the limits imposed by the competent judicial authority according to the legislation in force.

3.2. CAUSE AND CONTRIBUTING FACTORS

The accident under examination, as most aviation accidents, has been determined by a series of events linked one another, which caused the final ditching. The ditching was primarily due to the both engines flame out because of fuel exhaustion.

The incorrect replacement of the fuel quantity indicator (FQI) was one of the contributing factors which led irremediably to the accident.

The accident’s cause is therefore traceable firstly to the incorrect procedure used for replacing the FQI, by means of the operator’s maintenance personnel. This shall be considered the disruptive element, which caused the final ditching of the aircraft due to the lack of fuel that caused the shutdown of both engines.

As said before the accident was determined by a series of events (contributing factors) linked one another. Hereafter are listed some considered of major importance.

- Errors committed by ground mechanics when searching for and correctly identifying the fuel indicator.
- Errors committed by the flight crew: non-respect of various operational procedures.
- Inadequate checks by the competent office of the operator that flight crew were respecting operational procedures.
- Inaccuracy of the information entered in the aircraft management and spares information system and the absence of an effective control of the system itself.
- Inadequate training for aircraft management and spares information system use and absence of a responsible person appointed for managing the system itself.
- Maintenance and organization standards of the operator unsatisfactory for an adequate aircraft management.

- Lack of an adequate quality assurance system;
- Inadequate surveillance of the operator by the competent Tunisian authority.
- Installation characteristics of fuel quantity indicators (FQI) for ATR 42 and ATR 72 which made it possible to install an ATR 42 type FQI in an ATR 72, and *viceversa*.

The analysis of various factors that contributed to the event has been carried out according to the so called Reason's "Organizational accident" model.

Active failures, which had triggered the accident, are those committed both by ground mechanics/technicians the day before the event while searching for and replacing the fuel quantity indicator, and by the crew who did not verify and fully and accurately complete the aircraft's documentation, through which it would have been possible to perceive an anomalous situation regarding the quantity of fuel onboard.

Latent failures, however, remained concealed, latent in the operator's organizational system until, some active errors (by mechanics and pilots) were made, overcoming the system's defence barriers, causing the accident.

Analysing latent and active failures (errors) traceable to various parties, involved in the event in several respects, it clearly emerges that they were operating in a potentially deceptive organizational system. When latent failures remain within a system without being identified and eliminated, the possibility of mutual interaction increases, making the system susceptible for active failures, or not allowing the system to prevent them, in case of errors. Active failures were inserted in a context characterised by organizational and maintenance deficiencies.

The error that led to the accident was committed by mechanics who searched for and replaced the FQI, but this error occurred in an organizational setting in which, if everybody were operating correctly, probably the accident would not have occurred.

Inaccuracy of information entered in the aircraft management and spares information system, particularly regarding the interchangeability of items and the absence of an effective control of the system itself, has been considered in fact one of the latent failures that contributed to the event. The maintenance and organization standards of the operator, at the time of event, were not considered satisfactory for an adequate management of the aircraft.

The flight crew and maintenance mechanics/technicians involved in the event, when they made incorrect choices and took actions not complying with standard procedures, did not receive sufficiently effective aid from the system in order to avoid the error.

CHAPTER IV

SAFETY RECOMMENDATIONS

4. RECOMMENDATIONS

4.1. INTRODUCTION

The operator involved in the event has already undertaken a series of actions in order to eliminate maintenance and organization deficiencies, considered to be among the factors which contributed to the event. In particular, with the support of an foreign institution expert in certification, the operator undertook a series of structural and organizational changes which allowed the achieval, between the end of 2005 and the beginning of 2006, of quality system certification according to ISO 9001 standards for “Marketing of national and international scheduled and charter passenger flights”.

The operator started the human factor (HF) training for the whole staff (maintenance technicians, engineers and administration personnel). Flight crew had already followed, before the event, HF programs. Refresher programs have been defined and implemented for the whole staff of the Technical Department section concerning company procedures and line maintenance procedures, with particular reference to engines.

A new Technical Log Book (TLB) and relevant filling instruction have been compiled according to JAR-OPS 1 standards; in particular, the new TLB includes a part concerning refuelling and post-flight residual fuel registration, with relevant certifications. The format and instructions are similar to those used by JAR-OPS certified operators in European countries.

The operator has also verified the correctness of information entered in the Aircraft Management And Spares Information System (®AMASIS) regarding Part Numbers of usable parts and their interchangeability. A person responsible for entering the information in the system has been appointed.

On the basis of the above mentioned considerations concerning technical-operational reorganization actions already implemented by the operator, and monitoring programs for respect of safety standards by the authorities, it is not considered necessary to make any specific safety recommendations.

4.2. RECOMMENDATIONS ALREADY ISSUED

While the technical investigation was underway, three safety recommendations were issued, as follows.

Date of issue: September 6th, 2005

Addressee: European Aviation Safety Agency (EASA).

Text.

1. Should require an ATR 72 and ATR 42 fleet inspection in order to verify the installation of the applicable Fuel Quantity Indicator (ANSV-6/443-05/1/A/05).
2. Should consider the possibility to mandate a modification of the Fuel Quantity Indicator installation in order to prevent any incorrect fitting (ANSV-7/443-05/2/A/05).

Date of issue: December 5th, 2005

Addressee: European Aviation Safety Agency (EASA).

Text.

3. Should consider the possibility to change the fuel system certification regulation for public transport aircraft, in order to require that the fuel low level warning be independent from the fuel gauging systems (ANSV-13/443-05/3/A/05).

4.3. FURTHER RECOMMENDATIONS

The following further safety recommendations emerged from the analysis of evidence collected during the technical investigation. Each recommendation shows the relevant numbering, the addressee, followed when needed, by a brief summary of the reason for which the recommendation has been issued, and its text.

SAFETY RECOMMENDATION ANSV-16/443-05/4/A/07

Addressee: EASA.

Justification: The previously issued safety recommendation ANSV-13/443-05/3/A/05 concerns the possibility of carrying out an installation modification on FQIs in order to avoid installation of an ATR 42 type item on an ATR 72 and *viceversa*. The same type of recommendation was issued on October 25th, 2006, by German investigation authority (BFU recommendation no. 14/2006). EASA replied to this recommendation on April 10th, 2007, affirming that a risk evaluation would be made through specific meetings with the manufacturer. This in order to evaluate the opportunity and/or necessity of an installation modification for FQIs on ATR 42 and ATR 72 fleet aircraft.

Text: In expectation of the eventual installation modification of the FQI, consider the possibility of:

- a) requiring to operators whose fleet includes ATR 42 and ATR 72 aircraft to implement *ad hoc* maintenance procedures in order to avoid the installation of ATR 42 type FQIs on ATR 72 aircraft and *viceversa*;
- b) requiring the creation of labels to be applied on the FQIs in order to show which aircraft type they must be installed on, ATR 42 or ATR 72.

SAFETY RECOMMENDATION ANSV-17/443-05/5/A/07

Addressee: EASA.

Justification: The structure of “*ditching*” procedure shown in FCOM does not take into account the causes of ditching. In case of failure of both engines, it is quite difficult for the flight crew to adapt to recommendations shown in the emergency procedure. In absence of thrust, and without primary indications of aircraft instruments due to the subsequent power supply failure, it is in fact more difficult to coordinate all elements necessary to perform a good ditching procedure (speed, vertical speed, attitude, direction, instant and point of contact with the sea).

Text: Consider the possibility of integrating information available in emergency procedures concerning the ditching, in order to consider also the possibility of ditching without both engines operating.

SAFETY RECOMMENDATION ANSV-18/443-05/6/A/07

Addressees: EASA and FAA.

Justification: The search for a fuel indicator performed through the aircraft management and spares information system gave a negative result as the P/N of the FQI shown in the IPC contained a dash after the first three digits, while in the system’s database the P/N of the FQI was entered without the dash after the first three digits (P/N 748681-2). The aircraft spares information system used by the operator considered the dash after the first three digits as a digit, therefore the search gave a negative result. If the technician had searched without inserting the dash after the first three digits, he would have certainly seen the information concerning P/N 748681-2 on the screen. The FQI manufacturer stated that the dash, placed after the first three digits, was removed in 1992, for IT reasons. On the basis of available information, at present, there is no uniform international regulation concerning P/N assignment methods for components and/or instruments used in aviation.

Text: Consider the possibility of carrying out studies aimed to define guidelines and/or issue regulatory requirements, concerning P/N assignment methods for aviation components.

SAFETY RECOMMENDATION ANSV-19/443-05/7/A/07

Addressees: EASA and FAA.

Justification: At present there are no general regulations that oblige manufacturers to provide installation modifications for components with the same functions and ostensibly similar from a constructive point of view, but with different performance, which may be installed on various types/versions of aircraft belonging to the same family (i.e. Boeing B737-200, -400, -800; Airbus A319, A320, A321; ATR 42 and 72, etc.).

Text: Consider the possibility of carrying out studies aimed to define guidelines and/or issue regulatory requirements, concerning the possibility of providing suitable installation modifications on the aircraft or on the component itself, in order to avoid that components with same functions and ostensibly similar but with different performance, could be installed in error.

SAFETY RECOMMENDATION ANSV-20/443-05/8/A/07

Addressees: EASA, FAA and Tunisian DGAC.

Justification: among the contributing factors to the event there has been the non-correspondence between P/N of FQI entered in the aircraft management and spares information system database and the P/N provided in ATR official documentation (Illustrated Parts Catalogue - IPC).

Text: Consider the possibility that all air transport operators perform a systematic check of the correspondence between P/Ns shown in the applicable IPC with information contained/recorded in software/databases generally used for spares management, with particular reference to components which directly influence the aircraft's operation and safety.

SAFETY RECOMMENDATION ANSV-21/443-05/9/A/07

Addressees: EASA, FAA, ENAC and Tunisian DGAC.

Justification: Some passengers did not follow the instructions given by the cabin crew regarding preparation for ditching. Some of them, for instance, inflated their life jacket before ditching, which then became lost or damaged after the impact.

Text: Sensitize the airlines to the importance of the safety demonstration (briefing) addressed to the passengers, emphasising the importance of carefully following the cabin crew's instructions, especially during emergencies.

SAFETY RECOMMENDATION ANSV-22/443-05/10/A/07

Addressee: Tunisian DGAC.

Justification: The Operation manual used by the airline (*Manuel d'Exploitation - Generalites et Fondements*, GEN-OPS) applicable before the event was the one relating to another airline,

Tunisair, which held more than 80% shares in the capital stock of the operator involved in the accident. Tunisair's fleet did not include ATR 42/72 aircraft. After the event, on October 10th, 2005, the operator published a new GEN-OPS manual applicable for their airline operations, and had it approved by Tunisian DGAC.

Text: Perform an “*ad hoc*” check at national airlines concerning Operation manuals compliance with applicable legislation.

SAFETY RECOMMENDATIONS from ANSV-23/443-05/11/A/07 to ANSV-27/443-05/15/A/07

Addressee: Tunisian DGAC.

Justification: The text of the following recommendations originates from evidence found during the investigation, regarding the technical-operational management of flight crew of the operator involved with the event and from considerations that emerged from the analysis of the actions performed by flight crew and cabin crew when managing the emergency.

Text: In cabin crew applicants' selection procedures, provide selective criteria aimed also to check behaviour during emergency situations and subsequent conditions of potential stress. (ANSV-23/443-05/11/A/07)

Text: Consider the possibility of having joint Recurrent Training (flight crew and cabin crew) characterised by operational scenarios with characteristics similar to the event under examination (preparation for landing outside an airport/ditching, emergency evacuation of passengers, etc.). (ANSV-24/443-05/12/A/07)

Text: Integrate operational manuals available to ATR 42/72 aircraft flight crew (FCOM and QRH), including further information concerning the identification of engine flame out conditions (uncontrolled shutdown) and their management. (ANSV-25/443-05/13/A/07)

Text: Consider the possibility of introducing a flight data monitoring system, such as the Flight Data Monitoring, useful as a preventive tool. It has to be pointed out that ICAO Annex 6 (provision 3.2.6) recommends for operators of an aeroplane of a certificated takeoff mass in excess of 20.000 kg to establish and maintain a flight data analysis programme as part of its safety management system. (ANSV-26/443-05/14/A/07)

Text: Promote establishment of reporting systems which allow learning and reduction of risk conditions in technical-operational operations, both for the flight operation part and for the maintenance part. (ANSV-27/443-05/15/A/07)

SAFETY RECOMMENDATION ANSV-28/443-05/16/A/07

Addressees: Minister of Justice (Italy) and Minister of Transport (Italy).

Justification: Flight recorders (FDR and CVR) of the aircraft involved in the accident were opened, read and decoded 10 days after recovery. In particular, due to the limits imposed by the competent judicial authority according to the criminal procedure code in force, it was not possible for ANSV to perform the above mentioned operations immediately after the equipment became available, as it should happen and as it normally happens at international level during technical investigations. The delay in reading data contained in flight recorders of an aircraft may compromise the development of an efficient and rapid prevention action, in the interest of flight safety and therefore of public safety. It can also compromise the reading result of data contained in the devices, due to the possibility of damage to the relative medium on which the information is recorded, especially if the devices are not correctly preserved. In general it is noted that, according to current Italian legislation, the judicial authority, in the case of inquiries for different purposes on an event which is also subject to ANSV technical investigation, may prevent or delay the acquisition, by ANSV, of elements fundamental for technical investigation development, with serious consequences in terms of prevention in the interest of flight safety. It is important to highlight that the sole objectives of the FDR and CVR installation on the aircraft is just for flight safety enhancement and not to apportion blame or liability.

Text: it is recommended, as applicable for relevant addressees of this safety recommendation, to take necessary legislative initiatives aimed to ensure the possibility for ANSV, even in case of a pending judicial authority inquiry, to have immediate and unconditional access to all elements (*in primis*, to information contained in aircraft's flight recorders) necessary for the technical investigation.

SAFETY RECOMMENDATION ANSV-29/443-05/17/A/07

Addressees: Minister of Justice (Italy) and Minister of Transport (Italy).

Justification: During the technical investigation it has not been possible for ANSV to fully and rapidly ensure the rights of representatives and relevant consultants of foreign agencies appointed for technical investigations, according to provisions stated in Annex 13 of International Civil Aviation Convention (Annex 13 ICAO), due to the limits imposed by the competent judicial authority according to the penal procedure code in force.

Text: It is recommended, as applicable for relevant addressees of this safety recommendation, to take necessary legislative initiatives aimed to rapidly ensure, in Italy, the rights of accredited representatives and relevant consultants of foreign accident investigation authorities appointed for technical investigations, according to provisions stated in Annex 13 of International Civil Aviation Convention (Annex 13 ICAO) also in the event of a judicial authority inquiry.

SAFETY RECOMMENDATION ANSV-30/443-05/18/A/07

Addressees: Minister of Justice (Italy) and Minister of Transport (Italy).

Justification: The competent judicial authority, on the basis of the criminal procedure code in force, has made available to the parties the contents of the CVR installed on the aircraft involved in the accident. In the afternoon of the day in which the parties had access to the above mentioned content, some press agencies were also in its possession - it is not known how- and made it available to the public domain in written and in audio format. Some of the dialogues recorded by the CVR and made available to the public domain were not relevant for reconstructing the dynamics of the event. The unconditional circulation of CVR content conflicts with provisions 5.12 and 5.12.1 in Annex 13 of the International Civil Aviation Convention (Annex 13 ICAO) and can cause serious negative consequences regarding prevention, thus preventing avoidance of other accidents. In general, observations made for safeguarding CVR content may concern also radio recordings of communications between aircraft, between aircraft and ATC, as well as recordings of telephone calls made between ATC centres.

Text: It is recommended, as applicable for relevant addressees of this safety recommendation, to adopt necessary legislative initiatives to modify the Italian code, in order to make it consistent with provisions 5.12 and 5.12.1. in Annex 13 of the International Civil Aviation Convention (Annex 13 ICAO). In particular, such initiatives should aim to establish the principle that recordings contained in the cabin voice recorder (CVR), recordings concerning communications between aircraft and between aircraft and ATC centres, as well as recordings of telephone calls between ATC centres, can be used in judicial proceedings, limited to the parts that assume particular relevance for reconstructing the event, while other parts not relevant for event analysis shall not be made available, remaining permanently confidential.

LIST OF ATTACHMENTS

- ATTACHMENT A:** Event zone map with indication of engine shutdown points.
- ATTACHMENT B:** Extracts of ATR 72 FCOM and QRH pages.
- ATTACHMENT C:** Job Instruction Card (JIC) before and after the event, FQI manufacture details.
- ATTACHMENT D:** Safety recommendations already issued by ANSV and BFU.
- ATTACHMENT E:** ATR 72 fuel system, FCOM extracts.
- ATTACHMENT F:** Load and balance sheet for flights TUI 152F and TUI 1153, old and new logbook.
- ATTACHMENT G:** Document of interest concerning search and rescue phases.
- ATTACHMENT H:** Sequence of relevant events, relevant parameters diagrams, deduced from the FDR data.
- ATTACHMENT I:** Animated reconstruction of flight TUI 1153: take off from Bari and final phase of the flight. (Contained in the attached CD-ROM)
- ATTACHMENT L:** ANSV remarks on State's accredited comments.
- APPENDIX:**
1. TSB Canada comments.
 2. BEA France comments.
 3. DGAC Tunisia comments, received through the Embassy of Tunisia in Rome.

Above mentioned attachments are a true copy of original documents possessed by ANSV. In the attached documents the anonymity of people involved in the event has been respected, complying with provisions stated by Legislative Decree February 25th, 1999, no. 66

ATTACHMENT A

Event zone map with indication of engine shut down points

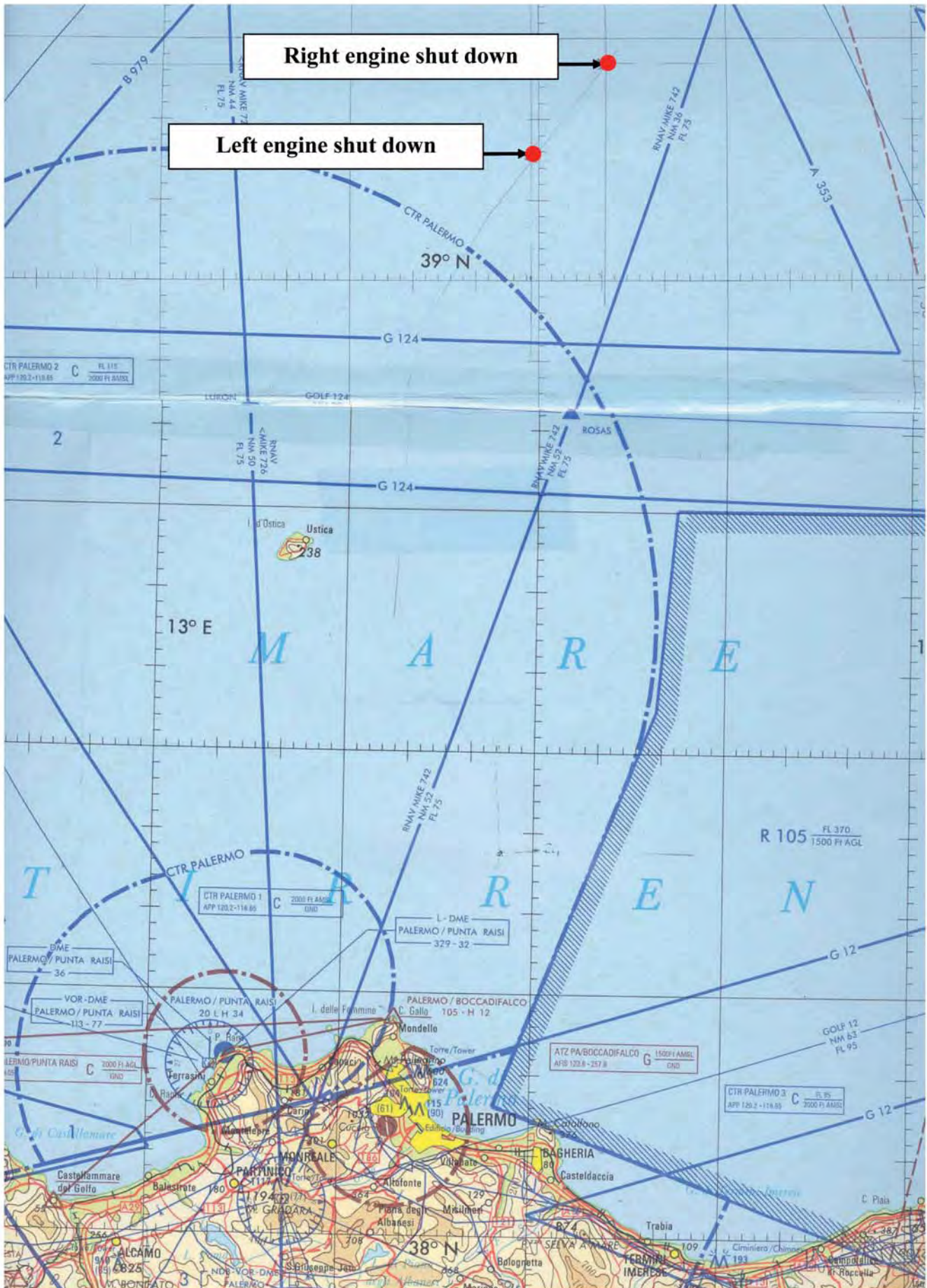

ATTACHMENT B

Extracts of ATR 72 FCOM and QRH pages

	EMERGENCY PROCEDURES CONTENTS	2.04.00		
		P 1	001	
				DEC 97

AA

2.04.00	CONTENTS
2.04.01	INTRODUCTION
2.04.02	POWER PLANT IN FLT ENG FIRE ON GND ENG FIRE BOTH ENGINES FLAME OUT ENG FLAME OUT AT TAKE OFF
2.04.03	SMOKE ELECTRICAL SMOKE AIR COND SMOKE FWD SMOKE AFT SMOKE AUX AFT COMPT SMOKE (if installed)
2.04.04	ELECTRICAL SYSTEM DUAL DC GEN LOSS
2.04.05	MISCELLANEOUS EMERGENCY DESCENT DITCHING FORCED LANDING ON GND EMER EVAC BOMB ON BOARD SEVERE ICING

R

R

R

	EMERGENCY PROCEDURES	2.04.01		
		P 1	001	
	INTRODUCTION			JUN 94

AA

GENERAL

The emergency procedures have been established for application in the event of a serious failure. They are applied according to the « READ AND DO » principle except for memory items.

R

PRESENTATION

The procedures are presented in the basic checklist format with an adjacent expanded part which provides :

- indication of the particular failure (alert condition)
- explanation for actions where the reason is not self evident
- additional background information.

The abbreviation used are identical to the nomenclature on the cockpit panels. All actions are printed in capital letters.

Memory items are BOXED for identification.

If actions depend on a precondition, a preceding black square ■ is used to identify the precondition.

A preceding black dot • is used to indicate the moment when actions have to be applied.

TASK SHARING

For all procedures the general task sharing stated below is applicable. The pilot flying remains pilot flying throughout the emergency procedure.

PF – Pilot flying Responsible for :

- . PL
- . Flight path and airspeed control
- . Aircraft configuration
- . Navigation

PNF – Pilot non flying Responsible for :

- . Check list reading
- . Execution of required actions
- . Actions on OVHD panel
- . CL
- . Communications

The AFCS is always coupled to the PF side (CPL selection).

 ATR 72 F.C.O.M.	EMERGENCY PROCEDURES		2.04.01	
	INTRODUCTION		P 2	001
				JUN 97

AA

PROCEDURES INITIATION

- No action will be taken (apart from depressing MW pb):
 - . Until flight path is stabilized.
- R . Under 400 ft above runway (except for propeller feathering after engine failure during approach at reduced power if go around is considered).
- Before performing a procedure, the crew must assess the situation as a whole, taking
 - R into consideration the failures, when fully identified, and the constraints imposed.

ANALYSIS OF CONSEQUENCES OF A FAILURE ON THE FLIGHT

Basic airmanship calls for a management review of the remaining aircraft capabilities under the responsibility of CM1.

CCAS

When TO INHI has been selected, until the first leg of landing gear unlocks, all alerts are inhibited except:

- ENG 1 FIRE
- ENG 2 FIRE
- CONFIG
- FLAPS UNLK
- LDG GEAR NOT DN
- EXCESS ALT
- PITCH DISCONNECT
- PROP BRK

	EMERGENCY PROCEDURES	2.04.02	
	POWER PLANT	P 3	001
			SEP 03

AA

BOTH ENGINES FLAME OUT**ALERT**

An engine flame out may be recognized by a rapid decrease in ITT and in NH.

PROCEDURE

BOTH ENGINES FLAME OUT	
ENG START rotary selector	CONT RELIGHT
PL both	FI
■ If NH drops below 30 % (no immediate relight)	
CL both	FTR then FUEL SO
FUEL SUPPLY	CHECK
<i>Note : See engine relight envelope (2.05.02)</i>	
OPTIMUM SPEED	Vm HB
CAPT EHSI	OFF
COMMUNICATIONS	VHF 1
ENG START rotary selector	START A & B
ENG 2 RELIGHT	
ENG 2 START pb	ON
At 10 % NH	
CL 2	FTR
ENG 2 RELIGHT	MONITOR
CL 2 then PL 2	AS RQD
ENG 1 RELIGHT	
ENG 1 START pb	ON
At 10 % NH	
CL 1	FTR
ENG 1 RELIGHT	MONITOR
CL 1 then PL 1	AS RQD
■ If neither engine starts	
CL both	FTR then FUEL SO
ENG START rotary selector	OFF/START ABORT
FUEL PUMPS	OFF
FORCED LANDING or DITCHING PROCEDURE	APPLY
CAUTION : Do not select AVIONICS VENT EXHAUST MODE to OVBD.	
■ If engine(s) recovered	
CL	MAX RPM
PL	AS RQD
SYSTEMS affected	RESTORE
ENG START rotary selector	CONT RELIGHT
CL	AS RQD

 AJR72 F.C.O.M.	EMERGENCY PROCEDURES	2.04.02		
		P 4	001	
	POWER PLANT			DEC 94

AA

COMMENTS

- Use of CONT RELIGHT during engine rundown when NH remains > 30 % may ensure a immediate restart.
- Fuel supply check consists of checking correct fuel quantity and correct pressure (no local pressure alert).
- The optimum airspeed to achieve best lift to drag ratio is $V_m HB$.

R - CAPT EHSI is selected OFF to recover composite mode.

IF BOTH ENG ARE LOST

- If landing gear extension is scheduled, emergency extension has to be performed.
- In short final, reduce speed as required by landing field in order to touch down with minimum vertical speed.
- If power supply still available is provided by batteries only, flaps' extension is impossible.

	EMERGENCY PROCEDURES POWER PLANT	2.04.02		
		P 5	001	
				JUN 97

AA

ENG FLAME OUT AT TAKE OFF**ALERT**

An engine flame out may be recognized by:

- Sudden dissymmetry
- TQ decrease
- Rapid ITT decrease

PROCEDURE

ENG FLAME OUT AT TAKE OFF	
ENG START rotary selector	CONT RELIGHT
UPTRIM	CHECK
AUTOFEATHER	CHECK
● At Acceleration Altitude	
PL	FI
CL	FEATHER then FUEL SO
■ If damage suspected	
FIRE HANDLE	PULL
SINGLE ENG OPERATION PROCEDURE	APPLY
■ If no damage suspected	
ENG RESTART IN FLT PROCEDURE	APPLY
■ If unsuccessful :	
SINGLE ENG OPERATION PROCEDURE	APPLY

	EMERGENCY PROCEDURES ELECTRICAL SYSTEM	2.04.04		
		P 1	001	
				JUL 99

AA

DUAL DC GEN LOSS**PROCEDURE**

DUAL DC GEN LOSS	
	DC GEN 1 and 2 OFF then ON
	■ If no generator recovered
	LAND ASAP
	MAN RATE KNOB 9 O'CLOCK
	CAB PRESS MODE SEL MAN
	BAT SW OVRD
R	<i>Note: If after a restart, a DC GEN becomes operative, set the BAT switch to ON</i>
	CAPT EHSI OFF
	ATC (VHF 1) NOTIFY
	MIN CAB LT OFF
R	<i>Note: NAV lights switch set to ON position is necessary to provide IEP illumination.</i>
	HF (if installed) OFF
	OMEGA (if installed) OFF
	STICK PUSHER/SHAKER OFF
	STICK PUSHER/SHAKER FAULT PROCEDURE APPLY
	AVIONICS VENT EXHAUST MODE OVBD
R	ADC SW SET to ADC 1
R	ATC SW SET to ATC 1
R	TLU MAN MODE LO SPD
	<i>After each TLU SW activation, check TLU FAULT light extinguishes then set TLU SW to AUTO</i>
	BUS EQT LIST CHECK
	MAIN BAT CHARGE (on LH maintenance panel) CHECK
	■ If STBY BUS UNDV light illuminates
R	STBY BUS For approach, OVRD only when necessary
	● Before descent
R	PAX INSTRUCTIONS USE PA
	HYD X FEED ON
	<i>Note: Selecting HYD X FEED to open position allows to recover green hydraulic system.</i>
	● At touch down
	IDLE GATE LEVER PULL

	EMERGENCY PROCEDURES ELECTRICAL SYSTEM	2.04.04		
		P 2	020	
				JUL 99

AA

COMMENTS

- BAT SW is selected OVRD in order to by-pass all the undervoltage protections and to ensure a correct supply of the EMER, ESS and STBY busses by the batteries.
- ATC communications must be performed with VHF 1 due to the loss of VHF 2.
- Both stick pusher and stick shaker are lost without FAULT alarm.
- Batteries will be lost according the following table :

START ATTEMPTS	TIME BEFORE UNDV ILLUMINATES	ADDITIONAL TIME WITHOUT STBY BUS OVRD	ADDITIONAL TIME WITH IMMEDIATE STBY BUS OVRD
0	50 mn		
1	42 mn		
2	35 mn	4 mn	2 mn

- As soon as both DC generators are lost, emergency exit lights will illuminate automatically.
 - As DC BUS 2 is lost, HYD GREEN PUMP is lost (powered by ACW BUS 2 but controlled by DC BUS 2).
HYD X FEED is opened in order to pressurize the whole hydraulic system from blue pump.
 - Loss of radio altimeter leads to untimely LDG GEAR NOT DOWN alarm when engine power is reduced.
 - TLU AUTO mode is lost and MAN MODE must be used.
MAN MODE acts on TLU stand by actuator which remains powered even if TLU is in LO SPD established position.
When TLU SW is set to AUTO position, TLU stand by actuator electrical power is off.
- R - PA must be used for pax instructions because cabin signs are not supplied in emergency.
- R

Model : 102-202-212

 ATR 72 F.C.O.M.	EMERGENCY PROCEDURES	2.04.05		
		P 2	080	
	MISCELLANEOUS			SEP 02

DITCHING
PROCEDURE

DITCHING

• **Preparation (time permitting)**

ATC (VHF1) NOTIFY
CABIN CREW NOTIFY
SIGNS ON
GPWS OFF
TERR OFF
CABIN and COCKPIT PREPARE
. Loose equipment secured
. Survival equipment prepared
. Belts and shoulder harness locked.
AUTO PRESS-LANDING ELEVATION SET

• **Approach**

AUTO PRESS (IF $\Delta P \neq 0$) DUMP
PACKS both OFF
OVBD VALVE FULL CLOSE
FLAPS (IF AVAILABLE) 30

Note : If power supply still available is provided by batteries only, flaps' extension is impossible.

L/G LEVER UP
DITCH pb (30 sec before the impact or 1250 ft above sea level) ON
ENG START rotary selector OFF/START ABORT
CABIN REPORT OBTAINED

• **Before ditching (200 ft)**

OPTIMUM PITCH ATTITUDE 9°
MINIMIZE IMPACT SLOPE
BRACE FOR IMPACT ORDER
CL both FTR then FUEL SO
FIRE HANDLES PULL
FUEL PUMPS OFF

Note : in case of night ditching, shutting down both engines may be performed, at captain discretion, immediately after the impact (to avoid loss of landing lights during flare out).

• **After ditching**

CABIN CREW (PA) NOTIFY
EVACUATION INITIATE
BAT (before leaving A/C) OFF

Note : After ditching, one aft door will be under the water line.

	EMERGENCY PROCEDURES	2.04.05		
		P 3	001	
	MISCELLANEOUS			DEC 96

AA

COMMENTS

- Notify ATC of the nature of the emergency encountered and state intentions. In the event of no ATC contact select ATC code A77 or transmit the distress message on one of the following frequencies (VHF) 121,5 MHz or (HF) 8364 KHz. Only VHF 1 is available on battery.
- Notify the cabin crew of the nature of emergency encountered and intentions. Specify the available time.
- Note : The direction of ditching is mainly dependent on wind and state of the sea and these factors may be assessed as follows :
 - 1) Wind direction :
This may be assessed by observing the waves which move and break down wind, spray from wave tops is also a reliable indication.
 - 2) Wind speed
The following conditions can be used as a guide to wind speed

R	A few white crests	8-17 kt
R	Many white crests	17-26 kt
R	Streaks of foam along water	23-35 kt
	Spray from waves	35-43 kt
 - 3) State of sea
This is better assessed from a height of 500 to 1000 ft particularly the direction of the swell which may not be obvious when seen from a lower altitude.
- When there is no swell, align into the wind. In the presence of a swell and provided that drift does not exceed 10 degrees, land parallel to the swell and as nearly into the wind as possible. If drift exceeds 10 degrees, land into wind. The presence of drift on landing is not dangerous but every effort should be made to minimize roll.
- For evacuation, open only the doors which are not under the water line.
- R - After using the DUMP function, the two pack valves are selected OFF to :
 - R * limit Δp .
 - R * prevent a untimely cabin inflation
 - R If the bleed valves are selected OFF, (also it induces the Pack valves shutting off), the venturi which creates the vacuum to the Dump function is no more supplied.
 - R
- R - Ditch pb must be activated at least 30 seconds before impact.

	EMERGENCY PROCEDURES		2.04.05	
	MISCELLANEOUS		P 4	001
			JUL 99	

AA

R AIRCRAFT ATTITUDE IN CASE OF DITCHING

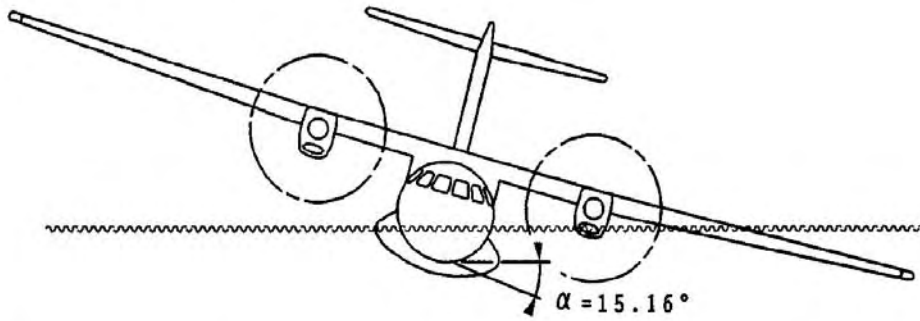

Note : This illustration is given as an example. It is not necessary the LH wing which is down.

R0FA-02-04-05-004-A001AA

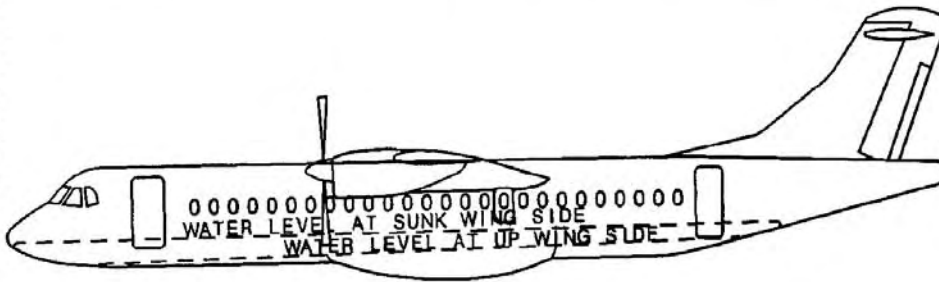

	PROCEDURES FOLLOWING FAILURE CONTENTS	2.05.00		
		P 1	001	
				JUL 01

2.05.00 CONTENTS

2.05.01 INTRODUCTION

2.05.02 POWER PLANT

SINGLE ENG OPERATION
 START FAULT
 NO NH DURING ENG START
 NO NL DURING ENG START
 NO ITT IND DURING ENG START
 NAC OVHT
 X START FAIL
 EXCESSIVE ITT DURING ENG START
 EXCESSIVE ITT
 ENG RESTART IN FLT
 ENG STALL
 ENGINE FLAME OUT
 ONE EEC FAULT
 BOTH EEC FAULT
 EEC SELECT IN FLT
 SYNPHR FAIL (If applicable)
 ATPCS FAIL
 IDLE GATE FAIL
 LOW PITCH IN FLT
 ENG OVER LIMIT
 PROP OVER LIMIT
 ENG OIL LO PR
 ENG OIL TEMP HI
 ENG OIL TEMP LO
 FUEL ABNORM TEMP
 FUEL CLOG
 PROP BRK UNLK (If applicable)
 PROP BRK UNLOCKING (ENG 2 stopped) (If applicable)
 PROP BRK (CAP alert) (If applicable)
 INCORRECT TQ INDICATION
 PEC 1 (2) SGL CH (If applicable)
 PEC 1 (2) FAULT (If applicable)
 R ONE PROPELLER REMAINING AT 100 % NP AFTER CLB PWR
 SELECTION (if applicable)

2.05.03 FUEL

FEED LO PR
 FUEL LO LVL

	PROCEDURES FOLLOWING FAILURE POWER PLANT	2.05.02		
		P 1	001	
				SEP 04

^{AA} **SINGLE ENG OPERATION**

PROCEDURE

SINGLE ENG OPERATION	
LAND ASAP	
CL non affected engine	MAX RPM
PWR MGT (both)	TO if necessary then MCT
SYNPHR	OFF
FUEL PUMP affected	OFF
DC GEN affected	OFF
ACW GEN affected	OFF
PACK affected	OFF
BLEED affected	OFF
TCAS (if installed)	TA only
OIL PRESSURE ON FAILED ENGINE	MONITOR
■ If FUEL X FEED is required	
FUEL PUMP affected	ON
FUEL X FEED	ON
FUEL PUMP on operating ENG	OFF
<i>Note: In icing conditions, Flaps 15 will be selected to improve drift down performances and single engine ceiling.</i>	
● For approach	
BLEED not affected	OFF
SINGLE ENGINE APPROACH SPEED FLAPS 30 IS EQUAL TO V _{mHB30} + WIND EFFECT OR 1.1 VMCA WHICHEVER IS HIGHER, UNTIL COMMITTED TO LAND.	
<i>Note: - At touch down, do not reduce below Fl before nose wheel is on the ground.</i>	
<i>- If during the flight, a positive oil pressure has been noted on the failed engine for a noticeable period of time, maintenance must be informed.</i>	

COMMENTS

- Refer to section Procedures and Techniques for fuel unbalance.
- For approach and landing, comply with Procedures and Techniques, Flight Patterns subsection.

R

	PROCEDURES FOLLOWING FAILURE POWER PLANT	2.05.02		
		P 8	001	
				JUN 97

AA

ENG RESTART IN FLT**PROCEDURE**

ENG RESTART IN FLT	
FUEL SUPPLY	CHECK
CL	FUEL SO
PL	FI
CAUTION : After ATPCS sequence PWR MGT rotary selector must be set to MCT position before engine restart in order to cancel propeller feathering.	
ENG START rotary selector	START A & B
EEC pb	RESET if necessary or DESELECT if FAULT persists
START pb	ON
At 10 % NH :	
CL	FTR
RELIGHT	MONITOR
CL then PL	ADJUST TO OTHER ENGINE
ENG START rotary selector	AS RQD
SYSTEMS affected	RESTORE

COMMENTS

- Engine relighting in flight is only guaranteed within the envelope and always necessitate starter assistance.

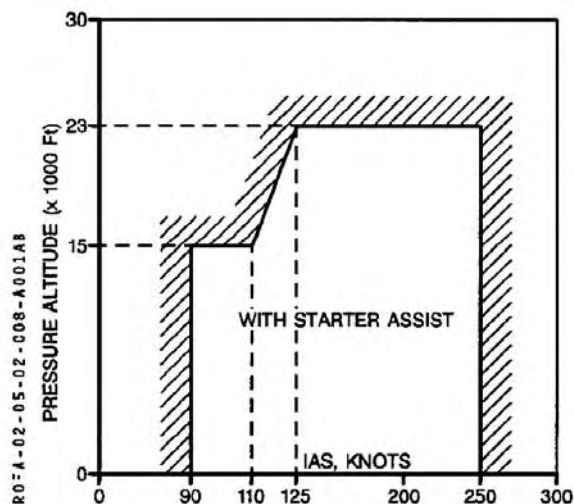

- The power may be restored immediately after relighting provided TOIL > 0 °C.
- Should the engine fail to light up within 10 s, select fuel to shut off, the ignition OFF and allow engine to be ventilated for 30 sec minimum prior to making another attempt.

	PROCEDURES FOLLOWING FAILURE POWER PLANT	2.05.02		
		P 10	001	
				DEC 94

AA

ENGINE FLAME OUT**ALERT**

An engine flame out may be recognized by :

- Sudden dissymmetry
- TQ decrease
- Rapid ITT decrease

PROCEDURE

ENGINE FLAME OUT	
ENG START rotary selector	CONT RELIGHT
PL	FI
<p>■ If NH drops below 30 % (no immediate relight)</p> <p>CL FTR THEN FUEL SO</p> <p>■ If damage suspected</p> <p>FIRE HANDLE PULL</p> <p>SINGLE ENG OPERATION PROCEDURE APPLY</p> <p>■ If no damages are suspected</p> <p>ENG RESTART IN FLT PROC APPLY</p> <p>■ If unsuccessful</p> <p>SINGLE ENG OPERATION PROCEDURE APPLY</p>	

R

COMMENTS

- Use of CONT RELIGHT during engine rundown ensures an immediate restart attempt and protects the non affected engine.
- Shut down the engine if no immediate relight.
- The causes of engine flame out can generally be divided into two categories :
 - External causes such as icing, very heavy turbulence, fuel mismanagement. These causes, which may affect both engines can generally be easily determined and an immediate relight can be attempted.
 - Internal causes which as engine stalls or failures usually affect a single engine and are not so easily determined. In these cases, the engine is shut down then the cause of the flame out investigated. If it cannot be positively determined what caused the flame out, the need for engine restart should be evaluated against the risk of further engine damage or fire that may result from a restart attempt.
- If damage is suspected, as precautionary measure, the FIRE handle is pulled.

	PROCEDURES FOLLOWING FAILURE FUEL	2.05.03		
		P 1	001	
				JUL 98

AA

FEED LO PR**ALERT**

CONDITION	VISUAL	AURAL
Engine feed low pressure (below 350 mbar/5 PSI)	<ul style="list-style-type: none"> - MC light flashing amber - FUEL amber light on CAP - associated FEED LO PR amber light on overhead panel. 	SC

PROCEDURE

FEED LO PR	
PUMP associated	CONFIRM ON
ENGINE associated	Monitor for possible run down
■ If engine runs down or if fuel quantity decreases significantly.	
PL	FI
CL	FTR then FUEL SO
PUMP associated	OFF
FIRE HANDLE	PULL
SINGLE ENG OPERATION PROCEDURE	APPLY
CAUTION : Do not open X FEED valve	

R

COMMENTS

- The illumination of FEED LO PR light associated with PUMP RUN light identifies a LEAK in the fuel line which may lead to engine rundown.
- If engine runs down or if fuel quantity decreases significantly, affected line must be isolated by selecting the pump OFF and by closing the fuel shut-off valve.
- If PUMP RUN does not illuminate, pump system may be defective and a X FEED attempt may be performed in order to restore engine supply. Max fuel unbalance has to be considered.

Eng. : PW 124

 ATR 72 F.C.O.M.	PROCEDURES FOLLOWING FAILURE	2.05.03		
		P 2	001	
				SEP 04
	FUEL			

AA

FUEL LO LVL**ALERT**

	CONDITION	VISUAL	AURAL
R	<ul style="list-style-type: none"> - Fuel tank low level (Fuel quantity indicator below 160 kg/352 lbs) - Fuel feeder tank high level lost (fuel quantity indicator over 160 kg/352 lbs) 	<ul style="list-style-type: none"> - MC light flashing amber - FUEL amber light on CAP - associated LO LVL amber light on FUEL QTY ind. 	SC

PROCEDURE

FUEL LO LVL
AVOID EXCESSIVE AIRCRAFT ATTITUDES

COMMENTS

- Excessive aircraft attitudes must be avoided to prevent pump unpriming.
 - It is considered as basic airmanship to use X FEED as required when possible.
- R - The fuel feeder tank high level lost is caused by the jet pump malfunction. In this case, 130 kg of the tank fuel is unusable (20 kg normally).

	PROCEDURES FOLLOWING FAILURE FUEL	2.05.03		
		P 3	001	
				SEP 04

AA

FUEL LEAK**ALERT**

CONDITION	VISUAL	AURAL
A fuel leak may be detected by either : -sum of fuel on board (FOB), read in steady flight at cruise level, and fuel used (FU), FOB+FU significantly less than fuel at departure or -passenger observation (fuel spray from engine or wing tip) or -total fuel quantity decreasing at an abnormal rate, or -fuel imbalance, or -a tank emptying too fast (leak from engine or a hole in a tank), or -excessive fuel flow (leak from engine), or -fuel smell in the cabin	-Nil-	-Nil-

PROCEDURE

FUEL LEAK
<ul style="list-style-type: none"> ● When a leak is confirmed <p>LAND ASAP</p> <ul style="list-style-type: none"> ■ Leak from engine (excessive fuel flow or feed spray from engine) PL (on affected engine) FI CL (on affected engine) FTR THEN FUEL SO PUMP associated OFF FIRE HANDLE (on affected engine) PULL SINGLE ENG OPERATION procedure APPLY (refer to 2.05.02 p1) ■ If excessive fuel flow was identified before engine shutdown, FUEL X FEED valve can be opened ■ In all other cases X FEED valve must remain closed ■ Leak not located FUEL X FEED MAINTAIN CLOSED <i>Note : the X feed must remain closed to prevent the leak affecting both sides</i> <p>BEFORE LANDING, NOTIFY ATC</p>

QRH

ATR	EMERGENCY	1.01	
		72	SEP 04 001

1 - EMERGENCY PROCEDURES**Content 1/1**

IN FLIGHT ENG FIRE	1.02
ON GROUND ENG FIRE	1.02
ON GROUND EMER EVACUATION	1.02
BOTH ENGINES FLAME OUT	1.03
ENG FLAME OUT AT TAKE OFF	1.04
BOMB ON BOARD	1.04
COCKPIT DOOR SECURITY SYSTEM	1.04A
ELEC SMK	1.05
AIR COND SMOKE	1.05
FWD SMK	1.06
AFT SMK	1.06
DUAL DC GEN LOSS	1.07
EMERGENCY DESCENT	1.08
DITCHING	1.08
FORCED LANDING	1.08A
SEVERE ICING	1.09

ATR	EMERGENCY	1.03	
		72	SEP 04 001

BOTH ENGINES FLAME OUT

ENG START ROTARY SELECTOR..... CONT RELIGHT
 PL BOTH.....FI

■ **If NH drops below 30 % (no immediate relight)**

CL BOTH..... FTR THEN FUEL SO
 FUEL SUPPLY..... CHECK

Note : See engine relight envelope (2.08)

OPTIMUM SPEED..... VmHB
 CAPT EHSI..... OFF
 COMMUNICATIONS..... VHF 1
 ENG START ROTARY SELECTOR..... START A & B

ENG 2 RELIGHT

ENG 2 START PB..... ON

● **At 10 % NH**

CL 2..... FTR
 ENG 2 RELIGHT..... MONITOR
 CL 2 then PL 2..... AS RQD

ENG 1 RELIGHT

ENG 1 START PB..... ON

● **At 10 % NH**

CL 1..... FTR
 ENG 1 RELIGHT..... MONITOR
 CL 1 then PL 1..... AS RQD

■ **If neither engine starts**

CL BOTH..... FTR THEN FUEL SO
 ENG START ROTARY SELECTOR..... OFF / START ABORT
 FUEL PUMPS..... OFF
 FORCED LANDING (1.08A) or DITCHING (1.08) procedure
APPLY

CAUTION : Do not select AVIONICS VENT EXHAUST MODE to
 OVBD

■ **If engine(s) recovered**

CL..... MAX RPM
 PL..... AS RQD
 SYSTEMS AFFECTED RESTORE
 ENG START ROTARY SELECTOR..... CONT RELIGHT
 CL..... AS RQD

ATR	EMERGENCY	1.04	
		72	SEP 04 001

ENG FLAME OUT AT TAKE OFF

ENG START ROTARY SELECTOR..... CONT RELIGHT
 UPTRIM..... CHECK
 AUTOFEATHER CHECK

- **At Acceleration Altitude**
 - PL..... FI
 - CL..... FTR THEN FUEL SO

- **If damage suspected**

FIRE HANDLE PULL
 SINGLE ENG OPERATION procedure (2.04)..... APPLY

- **If no damage suspected**

ENG RESTART IN FLIGHT procedure (2.08)..... APPLY

- **If unsuccessful**

SINGLE ENG OPERATION procedure (2.04)..... APPLY

BOMB ON BOARD

AUTO PRESS - LANDING ELEVATION..... CABIN ALTITUDE
 FLIGHT LEVEL..... DESCEND TO CABIN ALTITUDE
 AVOID LOAD FACTORS
 HANDLE BOMB CAREFULLY - AVOID SHOCKS

- **When Z aircraft = Z cabin**

APPROACH CONFIG : FLAPS 15 GEAR DOWN..... SELECTED
 AUTO PRESS..... DUMP
 SERVICE DOOR UNLOCK

PLACE BOMB NEAR SERVICE DOOR PREFERABLY IN A BAG
 ATTACHED TO THE DOOR HANDLE
 SURROUND IT WITH DAMPING MATERIAL

CABIN ATTENDANT OXYGEN AND FIRE EXTINGUISHER.....
 MOVE FORWARD
 PAX MOVE FORWARD / CRASH POSITION
 LAND ASAP

ATR	EMERGENCY	1.07	
		72	SEP 04 001

DUAL DC GEN LOSS

DC GEN 1 AND 2 OFF then ON

■ **If no generator recovered**

LAND ASAP

MAN RATE KNOB 9 O'CLOCK

CAB PRESS MODE SEL MAN

AVIONICS VENT EXHAUST MODE OVBD

BAT SW OVRD

Note : If after a restart, a DC GEN becomes operative, set the BAT switch to ON

CAPT EHSI OFF

ATC (VHF 1) NOTIFY

MIN CAB LIGHT OFF

Note : NAV lights switch set to ON is necessary to provide IEP illumination (if installed)

HF (if installed) OFF

OMEGA (if installed) OFF

STICK PUSHER / SHAKER OFF

STICK PUSHER / SHAKER FAULT procedure (2.22) APPLY

ADC SW SET TO ADC 1

ATC SW SET TO ATC 1

TLU MAN MODE LO SPD

After each TLU SW activation, check TLU FAULT light extinguishes then set TLU SW to AUTO

BUS EQUIPMENT LIST (2.17 - 2.18) CHECK

MAIN BATTERY CHARGE (on LH maintenance panel) CHECK

● **If STBY BUS UNDV light illuminates**

STBY BUS For approach, OVRD only when necessary

● **Before descent**

PAX INSTRUCTIONS USE PA

HYD X FEED ON

Note : Selecting HYD X FEED ON allows to recover green hydraulic system

● **At touch down**

IDLE GATE LEVER PULL

ATR 72	EMERGENCY	1.08	
		SEP 04	001

EMERGENCY DESCENT

PL BOTH	FI
ENG START ROTARY SELECTOR	CONT RELIGHT
CL BOTH	MAX RPM

OXYGEN PAX SUPPLY.....AS RQD
OXYGEN PRESSURE.....CHECK
OXYGEN MASKS / CREW COMMUNICATIONS.....AS RQD
SPEED.....MMO / VMO (or less if structural damage is suspected)
SIGNS.....ON
ATC.....NOTIFY
MEA.....CHECK

DITCHING

● **Preparation (time permitting)**

ATC (VHF1).....NOTIFY
CABIN CREW.....NOTIFY
SIGNS.....ON
GPWS.....OFF
TERR (If Enhanced GPWS installed).....OFF
CABIN AND COCKPIT.....PREPARE
- Loose equipment secured
- Survival equipment prepared
- belts and shoulder harnesses locked
AUTO PRESS - LDG ELEVATION.....SET
Note : Refer to 4.64 to determine approach speed.

● **Approach**

AUTO PRESS (If $\Delta P \neq 0$).....DUMP
PACKS BOTH.....OFF
OVBD VALVE.....FULL CLOSE
FLAPS (If available).....30
*Note : If power supply still available is provided by batteries only,
flaps extension is not possible.*
L/G LEVER.....UP
DITCH PB (30 s before impact or 1250 ft above sea level).....ON
ENG START ROTARY SELECTOR.....OFF / START ABORT
CABIN REPORT.....OBTAINED

● **Before ditching (200 ft)**

OPTIMAL PITCH ATTITUDE.....9°
MINIMIZE IMPACT SLOPE
BRACE FOR IMPACT.....ORDER
CL BOTH.....FTR THEN FUEL SO
FIRE HANDLES.....PULL
FUEL PUMPS.....OFF
*Note : In case of night ditching, shutting down both engines may be
performed at captain discretion, immediately after the
impact (avoiding loss of landing lights during flare out).*

● **After ditching**

CABIN CREW (PA).....NOTIFY
EVACUATION.....INITIATE
BAT (before leaving aircraft).....OFF
Note : After ditching, one aft door will be under the water line.

AR	EMERGENCY	1.08	
	72	SEP 04	001

EMERGENCY DESCENT

PL BOTH	FI
ENG START ROTARY SELECTOR	CONT RELIGHT
CL BOTH	MAX RPM

OXYGEN PAX SUPPLY.....AS RQD
OXYGEN PRESSURE.....CHECK
OXYGEN MASKS / CREW COMMUNICATIONS.....AS RQD
SPEED.....MMO / VMO (or less if structural damage is suspected)
SIGNS.....ON
ATC.....NOTIFY
MEA.....CHECK

DITCHING

- **Preparation (time permitting)**

ATC (VHF1).....	NOTIFY
CABIN CREW	NOTIFY
SIGNS	ON
GPWS	OFF
TERR (If Enhanced GPWS installed).....	OFF
CABIN AND COCKPIT	PREPARE

 - Loose equipment secured
 - Survival equipment prepared
 - belts and shoulder harnesses locked

AUTO PRESS - LDG ELEVATION	SET
----------------------------------	-----

Note : Refer to 4.64 to determine approach speed.
- **Approach**

AUTO PRESS (If $\Delta P \neq 0$)	DUMP
PACKS BOTH	OFF
OVBD VALVE	FULL CLOSE
FLAPS (If available)	30

Note : If power supply still available is provided by batteries only, flaps extension is not possible.

L/G LEVER	UP
DITCH PB (30 s before impact or 1250 ft above sea level)	ON
ENG START ROTARY SELECTOR	OFF / START ABORT
CABIN REPORT	OBTAINED
- **Before ditching (200 ft)**

OPTIMAL PITCH ATTITUDE	9°
MINIMIZE IMPACT SLOPE	
BRACE FOR IMPACT	ORDER
CL BOTH	FTR THEN FUEL SO
FIRE HANDLES	PULL
FUEL PUMPS	OFF

Note : In case of night ditching, shutting down both engines may be performed at captain discretion, immediately after the impact (avoiding loss of landing lights during flare out).
- **After ditching**

CABIN CREW (PA)	NOTIFY
EVACUATION	INITIATE
BAT (before leaving aircraft)	OFF

Note : After ditching, one aft door will be under the water line.

	EMERGENCY PROCEDURES		2.04.05	
	MISCELLANEOUS		P 2	080
				SEP 02

DITCHING
PROCEDURE

DITCHING

• **Preparation (time permitting)**

ATC (VHF1) NOTIFY
 CABIN CREW NOTIFY
 SIGNS ON
 GPWS OFF
 TERR OFF
 CABIN and COCKPIT PREPARE

. Loose equipment secured

. Survival equipment prepared

. Belts and shoulder harness locked.

AUTO PRESS-LANDING ELEVATION SET

• **Approach**

AUTO PRESS (IF $\Delta P \neq 0$) DUMP

PACKS both OFF

OVBD VALVE FULL CLOSE

FLAPS (IF AVAILABLE) 30

Note : If power supply still available is provided by batteries only, flaps' extension is impossible.

L/G LEVER UP

DITCH pb (30 sec before the impact or 1250 ft above sea level) ON

ENG START rotary selector OFF/START ABORT

CABIN REPORT OBTAINED

• **Before ditching (200 ft)**

OPTIMUM PITCH ATTITUDE 9°

MINIMIZE IMPACT SLOPE

BRACE FOR IMPACT ORDER

CL both FTR then FUEL SO

FIRE HANDLES PULL

FUEL PUMPS OFF

Note : in case of night ditching, shutting down both engines may be performed, at captain discretion, immediately after the impact (to avoid loss of landing lights during flare out).

• **After ditching**

CABIN CREW (PA) NOTIFY

EVACUATION INITIATE

BAT (before leaving A/C) OFF

Note : After ditching, one aft door will be under the water line.

	EMERGENCY PROCEDURES		2.04.05	
	MISCELLANEOUS		P 3	001
			DEC 96	

AA

COMMENTS

- Notify ATC of the nature of the emergency encountered and state intentions. In the event of no ATC contact select ATC code A77 or transmit the distress message on one of the following frequencies (VHF) 121,5 MHz or (HF) 8364 KHz. Only VHF 1 is available on battery.
- Notify the cabin crew of the nature of emergency encountered and intentions. Specify the available time.
- Note : The direction of ditching is mainly dependent on wind and state of the sea and these factors may be assessed as follows :
 - 1) Wind direction :
 - This may be assessed by observing the waves which move and break down wind, spray from wave tops is also a reliable indication.
 - 2) Wind speed
 - The following conditions can be used as a guide to wind speed
 - R A few white crests 8-17 kt
 - R Many white crests 17-26 kt
 - R Streaks of foam along water 23-35 kt
 - Spray from waves 35-43 kt
 - 3) State of sea
 - This is better assessed from a height of 500 to 1000 ft particularly the direction of the swell which may not be obvious when seen from a lower altitude.
- When there is no swell, align into the wind. In the presence of a swell and provided that drift does not exceed 10 degrees, land parallel to the swell and as nearly into the wind as possible. If drift exceeds 10 degrees, land into wind. The presence of drift on landing is not dangerous but every effort should be made to minimize roll.
- For evacuation, open only the doors which are not under the water line.
- R – After using the DUMP function, the two pack valves are selected OFF to :
 - R * limit Δp .
 - R * prevent a untimely cabin inflation
 - R If the bleed valves are selected OFF, (also it induces the Pack valves shutting off), the venturi which creates the vacuum to the Dump function is no more supplied.
 - R
- R – Ditch pb must be activated at least 30 seconds before impact.

	EMERGENCY PROCEDURES		2.04.05	
	MISCELLANEOUS		P 4	001
			JUL 99	

AA

R AIRCRAFT ATTITUDE IN CASE OF DITCHING

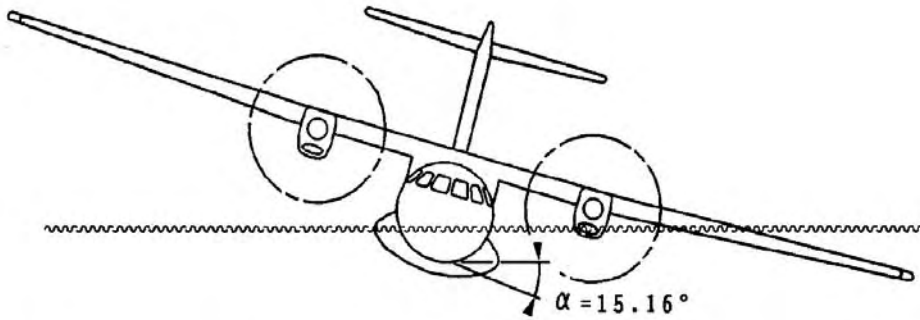

Note : This illustration is given as an example. It is not necessary the LH wing which is down.

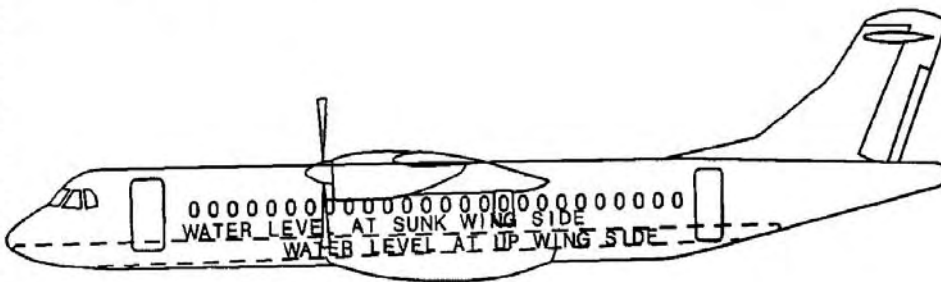

R3FA-02-04-05-004-A001AA

AR 72	FOLLOWING FAILURES POWER PLANT	2.04
		SEP 04 001

SINGLE ENG OPERATION

LAND ASAP
 CL NON AFFECTED.....MAX RPM
 PWR MGT BOTH.....TO if necessary then MCT
 SYNPHR AFFECTED OFF
 FUEL PUMP AFFECTED..... OFF
 DC GEN AFFECTED OFF
 ACW GEN AFFECTED OFF
 PACK AFFECTED OFF
 BLEED AFFECTED OFF
 TCAS (if installed)..... TA ONLY
 OIL PRESSURE ON FAILED ENGINE.....MONITOR

■ **If FUEL CROSS FEED is required**

FUEL PUMP AFFECTED ON
 FUEL X FEED ON
 FUEL PUMP ON OPERATING ENGINE OFF

Note : Refer to pages (4.61) and (4.62) to determine single engine gross ceiling.

Note : In icing conditions, FLAPS 15 will be selected to improve drift down performances and single engine ceiling.

● **For approach**

BLEED NOT AFFECTED OFF
 SINGLE ENGINE APPROACH SPEED IS EQUAL TO
 V_mHB 30 + WIND EFFECT OR 1.1VMCA WHICHEVER IS HIGHER
 UNTIL COMMITTED TO LAND.
 Refer to page (4.64) to determine 1.1VMCA.

Note : At touch down, do not reduce below FI before nose wheel is on the ground.

Note : If during the flight, a positive oil pressure has been noted on the failed engine for a noticeable period of time, maintenance must be informed.

START FAULT

ENG START ROTARY SELECTOR OFF / START ABORT

■ **If above 45 % NH**

START ON LIGHT CHECK EXTINGUISHED
 START TO BE CONTINUED

NO NH DURING ENG START

Note : In case of ENG 2 START in Hotel Mode without GPU, OIL PRESS is not available; in that case START ENG 1 and then ENG 2.

Wait for 10 seconds with the START pushbutton selected ON

■ **If OIL pressure increases**

CL..... FTR
 Continue START procedure, being informed NH indicator is inoperative.

■ **If OIL pressure does not increases**

ENG START ROTARY SELECTOR OFF / START ABORT
 Suspect starter motor failure. Maintenance action is due.

R
R
R
R

ATR 72	FOLLOWING FAILURES POWER PLANT	2.08
		SEP 04 001

ENG RESTART IN FLIGHT

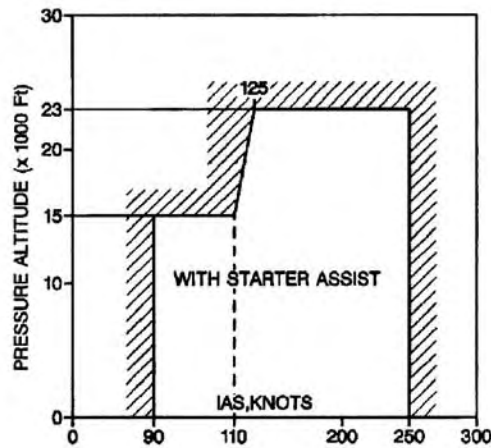

FUEL SUPPLY CHECK
 CL FUEL SO
 PL FI

CAUTION : After ATPCS sequence, PWR MGT rotary selector must be set to MCT position before engine restart, in order to cancel propeller feathering.

ENG START ROTARY SELECTOR START A & B
 EEC PB RESET if necessary or DESELECT if FAULT persists
 START PB ON

● **At 10 % NH**

CL FTR
 RELIGHT MONITOR
 CL then PL ADJUST TO OTHER ENGINE
 ENG START ROTARY SELECTOR AS RQD
 SYSTEMS AFFECTED RESTORE

ENG STALL

PL FI
 ENG START ROTARY SELECTOR CONT RELIGHT
 ENG PARAMETERS CHECK

■ **Abnormal**

CL FTR THEN FUEL SO
 SINGLE ENG OPERATION procedure (2.04) APPLY

■ **Normal**

ENG DE-/ANTI-ICING ON
 PL SLOWLY ADVANCE

■ **If stall recurs**

Reduce thrust and operate below the stall threshold

■ **If stall does not recur**

Continue engine operation

ATR 72	FOLLOWING FAILURES POWER PLANT	2.10
		SEP 04 001

EEC SELECT IN FLIGHT

On the side of the EEC to be selected :

PL.....RETARD IN GREEN SECTOR
 EEC..... ON
 PL..... ADJUST POWER (not to exceed the notch)
 ATPCS ON

ENG FLAME OUT

ENG START ROTARY SELECTOR..... CONT RELIGHT
 PL.....FI

- **If NH drops below 30 % (no immediate relight)**
 CL..... FTR THEN FUEL SO
- **If damage suspected**
 FIRE HANDLE PULL
 SINGLE ENG OPERATION procedure (2.04).....APPLY
- **If no damage suspected**
 ENG RESTART IN FLIGHT procedure (2.08).....APPLY
- **If unsuccessful**
 SINGLE ENG OPERATION procedure (2.04).....APPLY

ATPCS FAIL

- **If UPTRIM only is failed**
 MEL procedure (ATA 73 Dispatch with Uprim INOP)APPLY
- **If AUTOFEATHER only is failed**
 MEL procedure (ATA 61 Dispatch with AutoFeather INOP) .APPLY
- **If whole ATPCS system is failed (ARM light does not illuminate)**
 ATPCS OFF
 MEL procedure (ATA 61 Dispatch with ATPCS OFF)APPLY

IDLE GATE FAIL

- **In flight**
 IDLE GATE LEVER..... PUSH
- **At touch down**
 IDLE GATE LEVER..... PULL

SYNPHR FAIL

SYNPHR..... OFF
 NP BOTH.....ALIGN

LOW PITCH IN FLIGHT

PL.....FI
 CL..... FTR THEN FUEL SO
 SINGLE ENG OPERATION procedure (2.04).....APPLY

AR	FOLLOWING FAILURES FUEL	2.13	
		72	SEP 04 001

FUEL ABNORM TEMP

- **Too high (>50°C)**
 - Avoid rapid throttle movement
 - Monitor oil temperature and other engine parameters
- **Too low (<0°C)**
 - Use anti icing additive for next refueling if repair can't be accomplished

FUEL CLOG

- **If only one light is illuminated**
 - Associated ENGINE PARAMETERS.....MONITOR
- **If both lights are illuminated**
 - ENGINES PARAMETERS.....MONITOR
 - **After next landing, MAINTENANCE ACTION REQUIRED**

FEED LO PR

PUMP ASSOCIATED.....CONFIRM ON
ENGINE ASSOCIATEDMONITOR FOR POSSIBLE RUN DOWN

- **If engine runs down or if fuel quantity decreases significantly**
 - PL.....FI
 - CL..... FTR THEN FUEL SO
 - PUMP ASSOCIATED..... OFF
 - FIRE HANDLE PULL
 - SINGLE ENG OPERATION procedure (2.04).....APPLY

CAUTION : Do not open X FEED valve

FUEL LO LVL

AVOID EXCESSIVE AIRCRAFT ATTITUDES

ATR 72	FOLLOWING FAILURES FUEL	2.13A
		SEP 04 001

FUEL LEAK

ALERT CONDITION

A fuel leak may be detected by either :

- sum of fuel on board (FOB), read in steady flight at cruise level, and fuel used (FU), **FOB+FU** significantly less than fuel at departure, or
- total fuel quantity decreasing (fuel spray from engine or wing tip), or
- fuel imbalance, or
- a tank emptying too fast (leak from engine or a hole in a tank), or
- excessive fuel flow (leak from engine), or
- fuel smell in the cabin

● **When a leak is confirmed**

LAND ASAP

■ **Leak from engine (excessive fuel flow or feed spray from engine)**

PL (on affected engine) FI

CL (on affected engine) FTR THEN FUEL SO

PUMP ASSOCIATED OFF

FIRE HANDLE PULL

SINGLE ENG OPERATION procedure (2.04) APPLY

■ **If excessive fuel flow was identified before engine shutdown**

FUEL X FEED valve can be opened

■ **In all other cases X FEED valve must remain closed**

■ **Leak not located**

FUEL X FEED MAINTAIN CLOSED

Note : the X FEED must remain closed to prevent the leak affecting both sides.

BEFORE LANDING, NOTIFY ATC

AR 72	FOLLOWING FAILURES ELEC	2.16
		SEP 04 001

ACW BUS 1 OFF

R ACW GEN 1..... OFF
 LEAVE AND AVOID ICING CONDITIONS
 AS LONG AS ICING CONDITIONS EXIST,
 VISUALLY MONITOR ICE ACCRETION
 AFFECTED EQUIPMENT OFF
 CAPT AIRSPEED INDICATOR MONITOR
 HYD X FEED ON
 BUS EQUIPMENT LIST (2.17 - 2.18) CHECK
 ADC DISAGREEMENT procedure (2.32) APPLY

ACW BUS 2 OFF

ACW GEN 2..... OFF
 LEAVE AND AVOID ICING CONDITIONS
 AS LONG AS ICING CONDITIONS EXIST,
 VISUALLY MONITOR ICE ACCRETION
 AFFECTED EQUIPMENT OFF
 F/O AIRSPEED INDICATOR..... MONITOR
 HYD X FEED ON
 BUS EQUIPMENT LIST (2.17 - 2.18) CHECK
 ADC DISAGREEMENT procedure (2.32) APPLY
 TAXI ON BOTH ENGINES

ACW TOTAL LOSS

R ACW GEN BOTH..... OFF
 HYD X FEED CHECK OFF
 LEAVE AND AVOID ICING CONDITIONS
 AS LONG AS ICING CONDITIONS EXIST,
 VISUALLY MONITOR ICE ACCRETION
 AFFECTED EQUIPMENT OFF
 CAPT AND F/O AIRSPEED INDICATORS MONITOR
 MAIN HYD PUMPS..... OFF
 LANDING GEAR EXTENSION/RETRACTION LOST
 NORMAL BRAKE LOST
 LANDING DISTANCE MULTIPLY BY 1.5
Note : Refer to Chapter 4 to determine landing distance.
 BUS EQUIPMENT LIST (2.17 - 2.18) CHECK

- **Before landing**
 - L/G LEVER DOWN
 - BLUE PRESSURE CHECK
 - FLAPS AS RQD
 - L/G GRAVITY EXTENSION procedure (2.24)..... APPLY
- **After touch down**
 - USE FULL REVERSE IF NECESSARY
 - BRAKE HANDLE EMER AS RQD
 - TAXI ON BOTH ENGINES

ATR 72	FOLLOWING FAILURES ELEC	2.17	
		SEP 04	001

BUS EQPT LIST

SYS ↓	BUS FAILURES								BAT ONLY (ACW available)		
	DC BUS		AC BUS		STBY BUS (AC + DC)	ACW BUS			BASIC	STBY BUS UNDRV	STBY BUS OVRD
	1	2	1	2		1	2	1+2			
NAV / FLT INST	AHRS								# 2 LOST	# 2 * LOST	# 2 LOST
	ASI, VSI, ALTI				F/O LOST	CAPT LOST			F/O LOST	BOTH LOST	F/O LOST
	ADC		# 2 LOST		OUTPUT # 2 LOST				# 2 LOST	BOTH LOST	# 2 LOST
	EHSI	# 1 LOST	# 2 LOST						BOTH LOST	BOTH LOST	BOTH LOST
	VOR/ILS EADI/SGU		# 2 LOST			# 1 LOST			# 2 LOST	BOTH LOST	# 2 LOST
	DME	# 1 LOST	# 2 LOST						LOST	LOST	LOST
	ADF		# 2 LOST			# 2 LOST			# 2 LOST	BOTH LOST	# 2 LOST
	GPWS	LOST				LOST			LOST	LOST	LOST
	RADAR	LOST		LOST					LOST	LOST	LOST
	RADIO ALTI	LOST							LOST	LOST	LOST
	TAS/TAT/SAT									LOST	LOST
	RMI		# 1 LOST		# 1 LOST	# 2 LOST			# 1 LOST	BOTH LOST	# 1 LOST
	GPS									LOST	
AFCS	AFCS COMPTR	LOST							LOST	LOST	LOST
	AFCS ADU		LOST						LOST	LOST	LOST
COM	VHF		# 2 LOST						# 2 LOST	# 2 LOST	# 2 LOST
	HF									LOST	LOST
	ATC		# 2 LOST						# 2 LOST	# 2 LOST	# 2 LOST
HYD	MAIN PUMPS		GREEN LOST				BLUE LOST	GREEN LOST	BOTH LOST	GREEN LOST	GREEN LOST
	AUX PUMP		LOST							LOST	LOST
	PRESS IND									LOST	
	FLAPS					LOST				LOST	
	X FEEDVALVE					LOST	USE X FEED			LOST	
CCAS		Partially LOST **							AMBER ALERTS LOST	AMBER ALERTS LOST	AMBER ALERTS LOST

* AUTO ERECT LOST ON AHRS 1

**AMBER ALERTS OF CAP ARE LOST EXCEPT MFC, PRKG BRK, MAINT PNL

AR	72	FOLLOWING FAILURES ELEC	2.18	
			SEP 04	001

BUS EQPT LIST

SYS ↓	BUS FAILURES								BAT ONLY (ACW available)		
	DC BUS		AC BUS		STBY BUS (AC + DC)	ACW BUS			BASIC	STBY BUS UNDV	STBY BUS OVRD
	1	2	1	2		1	2	1+2			
FLT CTL	STICK PUSHER	LOST							LOST	LOST	LOST
	STICK SHAKER								LOST	LOST	LOST
	TRIM IND			LOST							
L/G and BRK	L/G RET		*		LOST		*	LOST	*	LOST	*
	L/G EXT		*		EMER ONLY		*	EMER **		EMER ONLY	
	L/G POS IND		OVHD PANEL LOST		MAIN PANEL LOST				OVHD PANEL LOST	BOTH LOST	OVHD PANEL LOST
	ANTI SKID		*							INB LOST	INB LOST
	LANDING LIGHTS					L LOST	R LOST	BOTH LOST			
	TAXI AND T.O. Lights		LOST				LOST	LOST	LOST	LOST	LOST
PWR PLANT	FF / FU / OIL T & P	# 1 LOST	# 2 LOST						BOTH LOST	BOTH LOST	BOTH LOST
	FQI									LOST	LOST
	SYNPHR	LOST							LOST	LOST	LOST
	AUTO IDLE GATE	LOST							LOST	LOST	LOST
	IDLE GATE FAIL IND		LOST						LOST	LOST	LOST
	PROP BRK if applicable									LOST	LOST
AIR	BLEED/PACK									LOST	LOST
	RECIRC / FAN	# 1 LOST	# 2 LOST						BOTH LOST	BOTH LOST	BOTH LOST
	PRESSU	AUTO LOST							AUTO LOST	AUTO LOST	AUTO LOST
ICE & RAIN	ICE DETECTOR							LOST			LOST
	HORNS ANTI ICE					R/D & LEFT ELEV LOST	AL & RIGHT ELEV LOST	BOTH LOST			
	PROP ANTI ICE					P1 LOST	P2 LOST	LOST			
	WIPERS		F/O LOST						F/O LOST	BOTH LOST	BOTH LOST
	MAIN WINDOW HTG					L FRONT LOST	R FRONT LOST	BOTH LOST			
	SIDE WINDOW HTG	L LOST	R LOST						BOTH LOST	BOTH LOST	BOTH LOST
	PROBE HTG					CAPT PTOT ALPHA TAT LOST	F/O PTOT ALPHA TAT LOST	CAPT + F/O LOST			
	STATICS PORTS	CAPT + F/O LOST	F/O LOST						ALL LOST	ALL LOST	ALL LOST

* HYD GREEN PUMP LOST / USE THE CROSS FEED

**USING HYD X FEED WHEN ONLY DC HYD PUMP IS AVAILABLE IS NOT RECOMMENDED

ATTACHMENT C

Job Instruction Card (JIC) before and after the event,
FQI manufacture details

Job Instruction Card... JIC 28-42-81 RAI 10000 REMOVAL/INSTALLATION OF FUEL QUANTITY IN

** ON A/C ALL

REMOVAL/INSTALLATION OF FUEL QUANTITY INDICATOR

TECHNICAL DATA

ZONING DATA

ZONE : 120
210

PREPARATION

..ORK	SKILL	MEN	MAN-HOURS
-------	-------	-----	-----------

ELAPSED TIME

SPARE	: 01 INDICATOR	284280-01-030
-------	----------------	---------------

PUBLICATION

JIC	<u>28-42-00-TST-10000</u>
-----	---------------------------

TASK DESCRIPTION

001 PREPARATION

REF. FIG. : 284272-FUT-00100

ON PANEL 121VU,
OPEN, SAFETY AND TAG THE FOLLOWING CIRCUIT
BREAKERS :

1QT FUEL/FQI/L TANK

2QT FUEL/FQI/R TANK

ITEM OF EQUIPMENT CONCERNED BY THE REMOVAL/
INSTALLATION PROCEDURE IS LOCATED ON LOWER
LEFT SECTION OF UPPER CENTER INSTRUMENT
PANEL 4VU.

002 STANDARD REMOVAL OF FLIGHT COMPARTMENT EQUIPMENT

NOTE:THE SHAPE OF LOCKING COLLARS,THE QUANTITY

Customer : TU

Page 1/4

Rev : avr. 01/05

Job Instruction Card

VAR 28-42-00 TST 10000 001

- A. PLACE
 - REFUELING/REFUEL/OFF/DEFUEL SWITCH 4QU IN OFF POSITION
 - REFUELING/REFUEL VALVE/L(R) SWITCH 5QU (6QU) IN SHUT POSITION.
- B. PRESS REFUELING/FQI TEST PUSHBUTTON SWITCH AND THEN RELEASE, NO DISPLAY.
- 2. ON PANEL 121VU,
 - A. CLOSE CIRCUIT BREAKERS 1QT (2QT).
 - B. ON PANEL 4VU, LEFT (RIGHT) FUEL QUANTITY INDICATOR 3QT READS FUEL QUANTITY REMAINING IN TANK CONCERNED.
- 3. ON PANEL 121VU
 - A. OPEN CIRCUIT BREAKERS 1QT (2QT).
 - B. ON PANEL 4VU, LEFT (RIGHT) FUEL QUANTITY INDICATOR 3QT DOES NOT GIVE ANY READING.
- 4. ON PANEL 121VU.
 - A. CLOSE CIRCUIT BREAKERS 1QT (2QT) AND THEN 2QU.
 - B. ON PANEL 4VU, FUEL QUANTITY INDICATOR 3QT READS QUANTITY REMAINING.
- 5. ON REFUELING PANEL 5004VU :
 - A. PRESS AND HOLD REFUELING FQI TEST PUSHBUTTON SWITCH 4QT.
 - ON PANEL 4VU, LEFT (RIGHT) FUEL QUANTITY INDICATOR 3QT READS 8888.
 - B. RELEASE REFUELING FQI TEST PUSHBUTTON SWITCH 4QT
 - ON PANEL 4VU LEFT (RIGHT) FUEL QUANTITY INDICATOR 3QT READS FUEL QUANTITY REMAINING IN TANK CONCERNED.
 - C. PLACE REFUELING/REFUEL VALVE/L(R) TANK SWITCH 5QU (6QU) IN NORM POSITION.
- 6. ON PANEL 4VU
 - A. PRESS AND HOLD FUEL QUANTITY INDICATOR 3QT TEST PUSHBUTTON SWITCH
 - LEFT (RIGHT) FUEL QUANTITY INDICATOR 3QT READS : 8888.
 - "LOW LEVEL" LIGHT L (R) COMES ON.
 - B. RELEASE FUEL QUANTITY INDICATOR 3QT TEST PUSHBUTTON SWITCH
 - LEFT (RIGHT) FUEL QUANTITY INDICATOR 3QT READS FUEL QUANTITY REMAINING IN TANK CONCERNED.
 - "LOW LEVEL" LIGHT L (R) GOES OFF.
- 7. ON PANEL 121VU
 - A. OPEN CIRCUIT BREAKERS 1QT (2QT).
 - B. ON PANEL 4VU, FUEL QUANTITY INDICATOR 3QT DOES NOT GIVE ANY READING.

004 ENERGIZATION OF FUEL QUANTITY INDICATOR

- 1. ON PANEL 121VU
 - A. CLOSE THE FOLLOWING CIRCUIT BREAKERS :
 - 1QT, 2QT, 2QU.

Job Instruction Card..

VAR 28-42-00 TST 10000 001

005 DE-ENERGIZATION OF AIRCRAFT DC AND AC CONSTANT FREQUENCY NETWORK

SEE JOB INSTRUCTION CARD

JIC : 244600-EAD-10000

Job Instruction Card JIC 28-42-81 RAI 10000 : REMOVAL/INSTALLATION OF FUEL QUANTITY IN

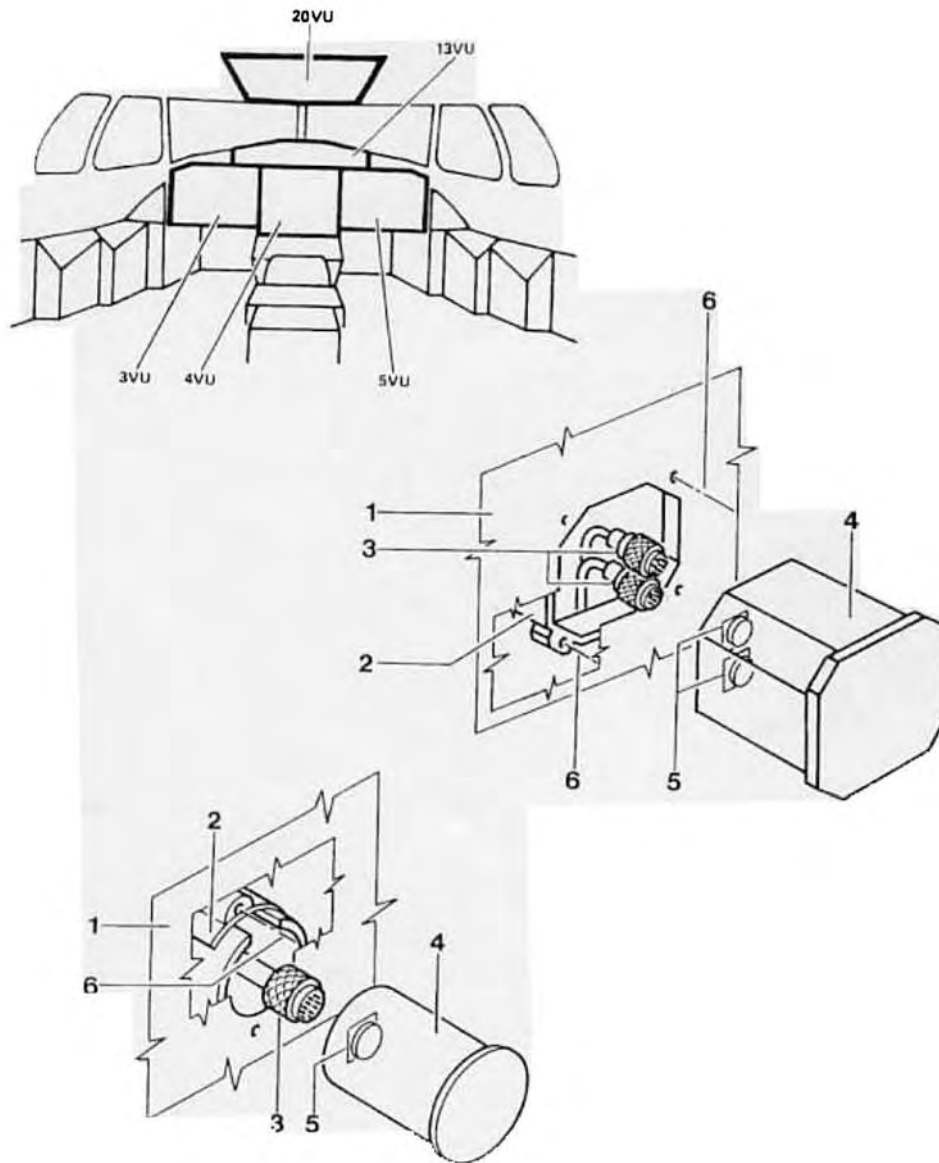

9SMJ 310000 RAI 00101 -- 001 AAD/FAD

FIGURE31-00-00-RAI-00101-001
FLIGHT COMPARTMENT EQUIPMENT

Job Instruction Card...

VAR 28-42-00 TST 10000 001

**** ON A/C ALL****TEST OF FUEL QUANTITY INDICATOR****TECHNICAL DATA****ZONING DATA**

ZONE : 192

210

ACCESS : 192 JR

PREPARATION

WORK	SKILL	MEN	MAN-HOURS
------	-------	-----	-----------

ELAPSED TIME

PUBLICATIONJIC 24-46-00-EAD-10000**TASK DESCRIPTION****001 ENERGIZATION OF AIRCRAFT DC AND AC CONSTANT FREQUENCY NETWORK**

SEE JOB INSTRUCTION CARD

JIC : 244600-EAD-10000**002 DE-ENERGIZATION OF FUEL QUANTITY INDICATOR**

1. ON PANEL 121VU

A. OPEN THE FOLLOWING CIRCUIT BREAKERS :

- 1 QT (2QT) FUEL/FQI/NORM PWR SUPPLY/L
(R) TANK.
- 2QU FUEL/FUELLING/CTL & IND.

003 TEST OF FUEL QUANTITY INDICATORREF. FIG. : 282573-FUT-00120

1. ON REFUELING PANEL 5004VU

Customer : TU

Page : 1/4

Rev : avr. 01/05

Job Instruction Card JIC 28-42-81 RAI 10000 : REMOVAL/INSTALLATION OF FUEL QUANTITY IN

OF BINDING SCREWS AS WELL AS THE SHAPE AND QUANTITY OF CONNECTORS MAY BE DIFFERENT ACCORDING THE EQUIPMENT. NEVERTHELESS, THE REMOVAL AND INSTALLATION PROCEDURE IS IDENTICAL.

REF. FIG. : 310000-RAI-00101

CAUTION: DO NOT LOOSEN LOCKING COLLAR ATTACHMENT SCREWS.

1. REMOVE CABIN PANEL VU (1).
2. SUFFICIENTLY LOOSEN BINDING SCREWS (6) OF EQUIPMENT LOCKING COLLAR (2) ON CABIN PANEL VU (1). (DO NOT COMPLETELY UNSCREW).
3. PULL EQUIPMENT (4) ALONG ITS LOCKING COLLAR (2).
4. DISCONNECT CONNECTORS (3) FROM RECEPTACLE (5)
5. REMOVE EQUIPMENT (4).
6. INSTALL PROTECTIVE CAP ON EACH CONNECTOR (3) AND ON EACH RECEPTACLE (5).

003 STANDARD INSTALLATION OF FLIGHT COMPARTMENT EQUIPMENT**REF. FIG. : 310000-RAI-00101**

1. CLEAN AND INSPECT INSTRUMENT CABIN PANEL VU (1) AND EQUIPMENT (4) INTERFACE AREA.
2. REMOVE PROTECTIVE CAPS INSTALLED ON CONNECTORS (3) AND RECEPTACLES (5).
3. MAKE CERTAIN THAT PINS ARE IN CORRECT CONDITION AND CONNECT CONNECTORS (3) WITH RECEPTACLES (5).
4. INSTALL EQUIPMENT (4) BY SLIDING IT ALONG ITS LOCKING COLLAR (2).
5. POSITION EQUIPMENT AND TIGHTEN LOCKING COLLAR (2) BINDING SCREWS (6).
6. INSTALL CABIN VU PANEL (1).

04 CLOSE-UP

1. ON PANEL 121VU,
REMOVE SAFETY CLIPS AND TAGS AND CLOSE CIRCUIT BREAKERS: 1QT, 2QT

005 TEST OF FUEL QUANTITY INDICATOR

SEE JOB INSTRUCTION CARD

JIC : 284200-TST-10000

Job Instruction Card... JIC 28-42-81 RAI 10000 : REMOVAL/INSTALLATION OF FUEL QUANTITY IN

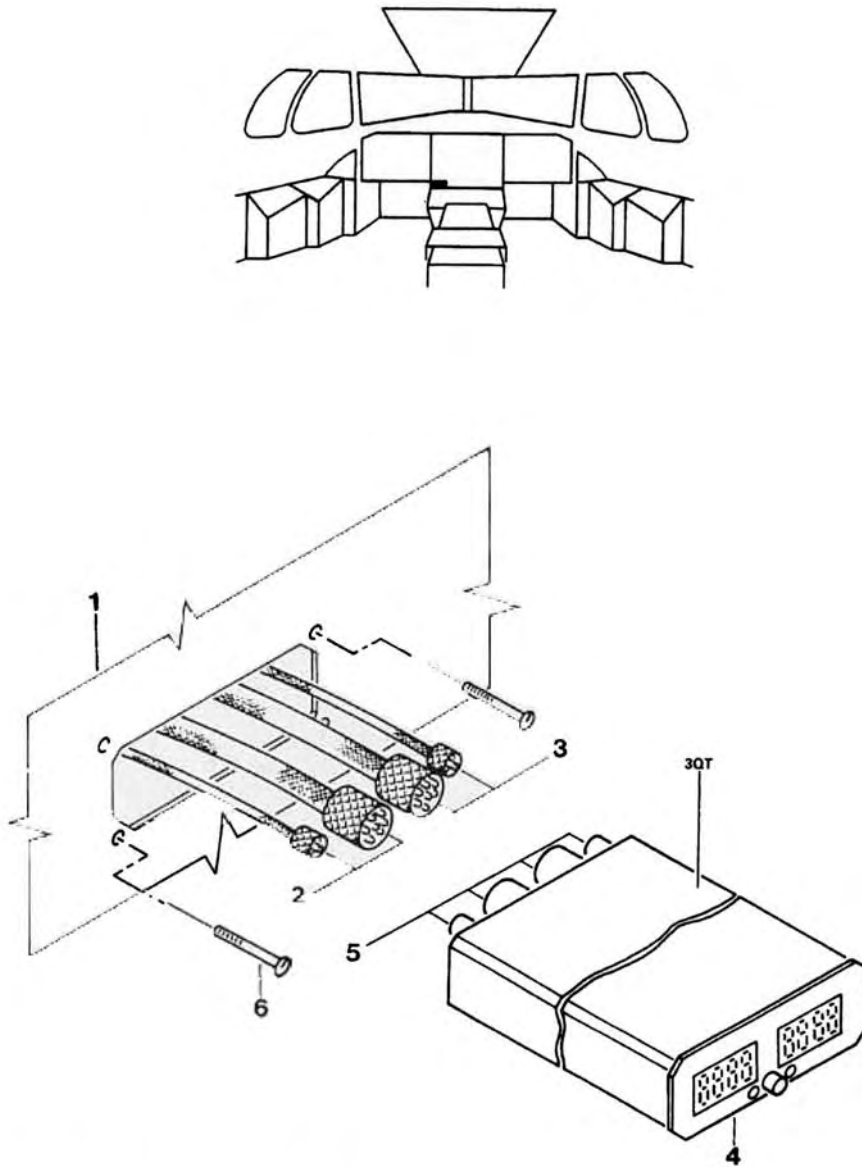

9SMJ 284272 FUT 00100 - 001 AAD/FAD

**FIGURE28-42-72-FUT-00100-001
COCKPIT FUEL QUANTITY INDICATING**

Job Instruction Card...

VAR 28-42-00 TST 10000 001

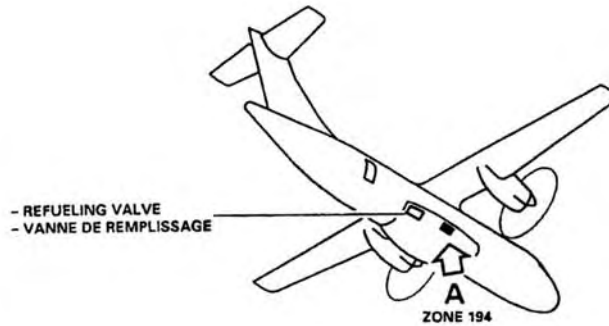

A

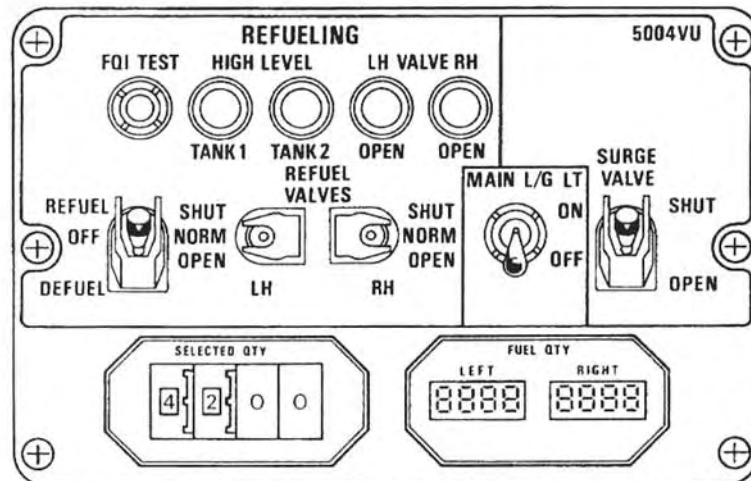

9SMJ 282573 FUT 00120-006 AAA/FAA

**FIGURE28-25-73-FUT-00120-006
DEFUEL/REFUEL PANEL**



Customer :
 Type : ATR72
 Rev. Date : Apr 01/06

Manual: AMMJIC
 Selected effectivity: ALL

JIC 28-42-81 RAI 10000 : REMOVAL/INSTALLATION OF FUEL QUANTITY INDICATOR

REMOVAL/INSTALLATION OF FUEL QUANTITY INDICATOR

**** ON A/C ALL**

TECHNICAL DATA

ZONING DATA

ZONE : 120
 210

PREPARATION

SPARES : 01 INDICATOR 284280-01-030

PUBLICATIONS

JIC : 28-42-00-TST-10000

TASK DESCRIPTION

001 PREPARATION

REF. FIG. :284272-FUT-00100

ON PANEL 121VU,

OPEN, SAFETY AND TAG THE FOLLOWING CIRCUIT

BREAKERS :

1QT FUEL/FQ/L TANK

2QT FUEL/FQ/R TANK

ITEM OF EQUIPMENT CONCERNED BY THE REMOVAL/

INSTALLATION PROCEDURE IS LOCATED ON LOWER

LEFT SECTION OF UPPER CENTER INSTRUMENT

PANEL 4VU.

002 STANDARD REMOVAL OF FLIGHT COMPARTMENT EQUIPMENT

NOTE:THE SHAPE OF LOCKING COLLARS,THE QUANTITY OF BINDING SCREWS AS WELL AS THE SHAPE AND QUANTITY OF CONNECTORS MAY BE DIFFERENT ACCORDING THE EQUIPMENT.

NEVERTHELESS,THE REMOVAL AND INSTALLATION PROCEDURE IS IDENTICAL.

REF. FIG. :310000-RAI-00101

Print Date: Jul 11/06

Page 1 of 7



Customer :
 Type : ATR72
 Rev. Date : Apr 01/06

Manual: AMMJIC
 Selected effectivity: ALL

JIC 28-42-81 RAI 10000 : REMOVAL/INSTALLATION OF FUEL QUANTITY INDICATOR

CAUTION: DO NOT LOOSEN LOCKING COLLAR ATTACHMENT SCREWS.

1. REMOVE CABIN PANEL VU (1).
2. SUFFICIENTLY LOOSEN BINDING SCREWS (6) OF EQUIPMENT LOCKING COLLAR (2) ON CABIN PANEL VU (1).(DO NOT COMPLETELY UNSCREW).
3. PULL EQUIPMENT (4) ALONG ITS LOCKING COLLAR (2).
4. DISCONNECT CONNECTORS(3) FROM RECEPTACLE (5)
5. REMOVE EQUIPMENT (4).
6. INSTALL PROTECTIVE CAP ON EACH CONNECTOR (3) AND ON EACH RECEPTACLE (5).

003 STANDARD INSTALLATION OF FLIGHT COMPARTMENT EQUIPMENT

REF. FIG. :310000-RAI-00101

1. CLEAN AND INSPECT INSTRUMENT CABIN PANEL VU (1) AND EQUIPMENT (4) INTERFACE AREA.
2. REMOVE PROTECTIVE CAPS INSTALLED ON CONNECTORS (3) AND RECEPTACLES (5).
3. MAKE CERTAIN THAT PINS ARE IN CORRECT CONDITION AND CONNECT CONNECTORS (3) WITH RECEPTACLES (5).
4. INSTALL EQUIPMENT (4) BY SLIDING IT ALONG ITS LOCKING COLLAR (2).
5. POSITION EQUIPMENT AND TIGHTEN LOCKING COLLAR (2) BINBING SCREWS (6).
6. INSTALL CABIN VU PANEL (1).

004 CLOSE-UP

1. ON PANEL 121VU,
 REMOVE SAFETY CLIPS AND TAGS AND CLOSE
 CIRCUIT BREAKERS: 1QT,2QT

005 TEST OF FUEL QUANTITY INDICATOR

SEE JOB INSTRUCTION CARD

JIC : 284200-TST-10000

Print Date: Jul 11/06

Page 2 of 7



Customer .
 Type : ATR72
 Rev. Date : Apr 01/06

Manual: AMMJIC
 Selected effectivity: ALL

JIC 28-42-81 RAI 10000 : REMOVAL/INSTALLATION OF FUEL QUANTITY
 INDICATOR

006 CROSSCHECK OF FUEL QUANTITY ON BOARD

REF. FIG. :284281-CHK-00100

REF. FIG. :284281-CHK-00110

CHECK CHOERENCE OF FUEL QUANTITY INDICATED ON
 THE FQI AND THE PHYSICAL QUANTITY IN THE
 TANKS BY MEAN OF DRIPSTICKS.

SEE JOB INSTRUCTION CARD:

12-11-28 CHK 10000

CONVERT VOLUME OBTAINED THROUGH DRIPSTICK IN
 WEIGHT BY MEAN OF CONVERSION TABLE OF FIGURES

TAKING INTO ACCOUNT FUEL DENSITY OF THE DAY.

(Ref Fig. 28-42-81 VOLUME/WEIGHT CROSSCHECK OF FUEL QUANTITY)

(Ref Fig. 28-42-81 VOLUME/WEIGHT CROSSCHECK OF FUEL QUANTITY)

28-42-81 VOLUME/WEIGHT CROSSCHECK OF FUEL QUANTITY

28-42-81 VOLUME/WEIGHT CROSSCHECK OF FUEL QUANTITY

Customer
 Type : ATR72
 Rev. Date : Apr 01/06

JIC 28-42-81 RAI 10000 : REMOVAL/INSTALLATION OF FUEL QUANTITY INDICATOR

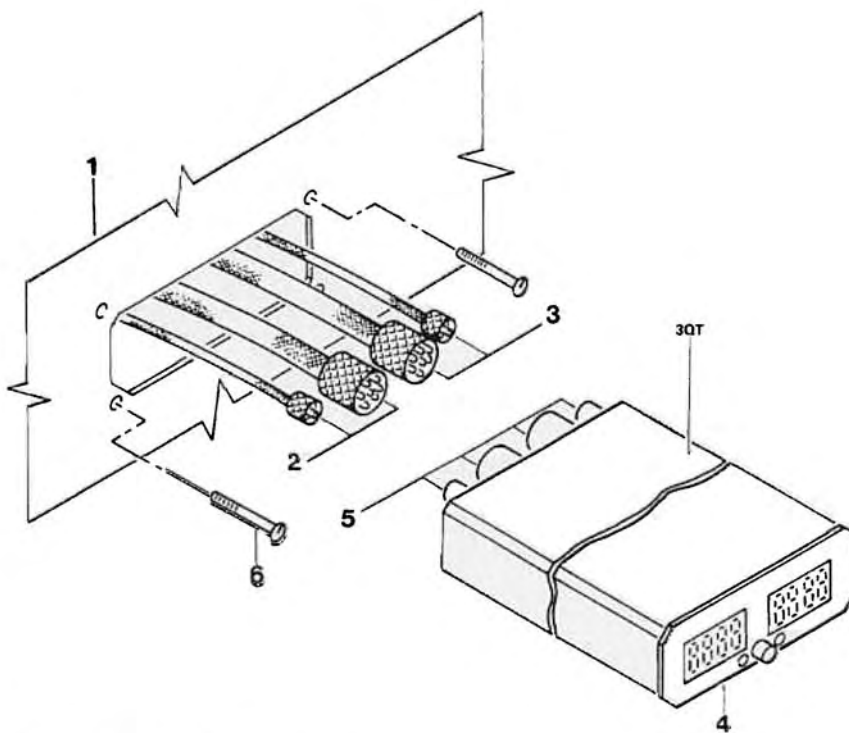
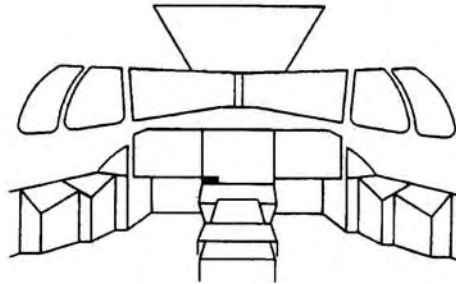

9SMJ 284272 FUT 00100 - 001 AAD/FAD

Figure 28-42-72-FUT-00100-001 - COCKPIT FUEL QUANTITY INDICATING

Customer :
 Type : ATR72
 Rev. Date : Apr 01/06

Manual: AMMJIC
 Selected effectivity: ALL

JIC 28-42-81 RAI 10000 : REMOVAL/INSTALLATION OF FUEL QUANTITY INDICATOR

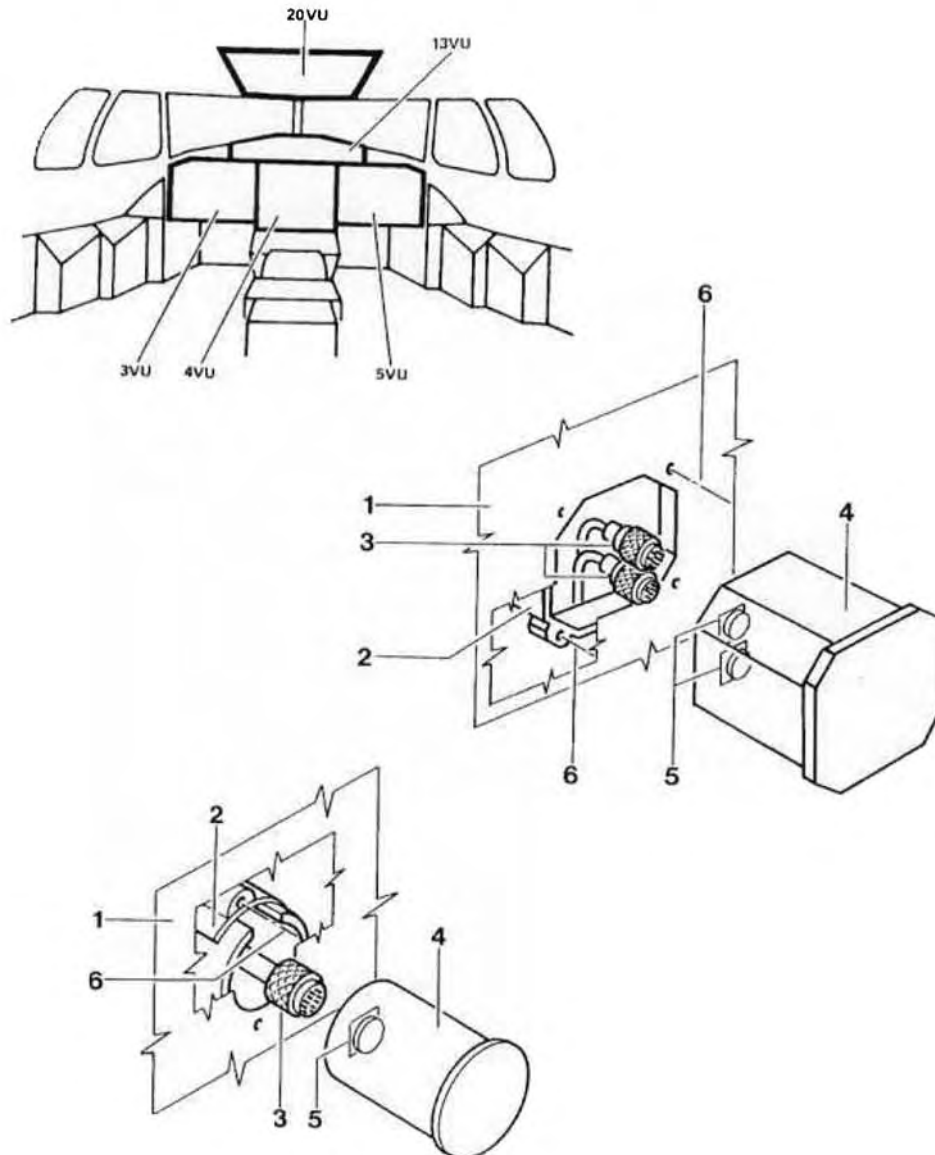

9SMJ 310000 RAI 00101 -- 001 AAD/FAD

Figure 31-00-00-RAI-00101-001 - FLIGHT COMPARTMENT EQUIPMENT



Customer
 Type : ATR72
 Rev. Date : Apr 01/06

Manual: AMMJIC
 Selected effectivity: ALL

JIC 28-42-81 RAI 10000 : REMOVAL/INSTALLATION OF FUEL QUANTITY INDICATOR

LOADING - FUEL - BALANCE CHART
 FUEL LOADING LBS

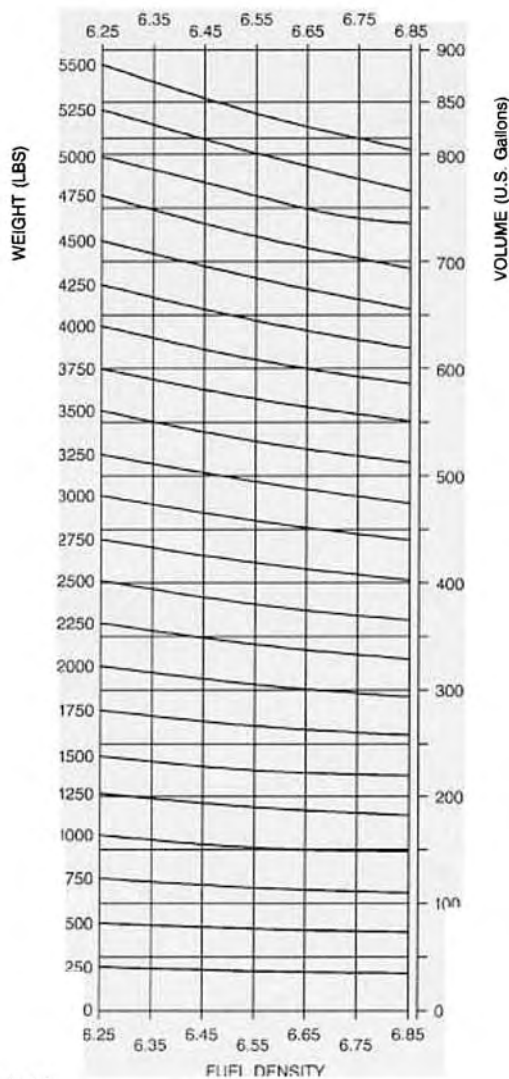

SJ5 284281 CHK 00100 001 A AA

Figure 28-42-81-CHK-00100-001 - VOLUME/WEIGHT CROSSCHECK OF FUEL QUANTITY



Customer:
 Type : ATR72
 Rev. Date : Apr 01/06

Manual: AMMJIC
 Selected effectivity: ALL

JIC 28-42-81 RAI 10000 : REMOVAL/INSTALLATION OF FUEL QUANTITY INDICATOR

LOADING - FUEL - BALANCE CHART
 FUEL LOADING KG

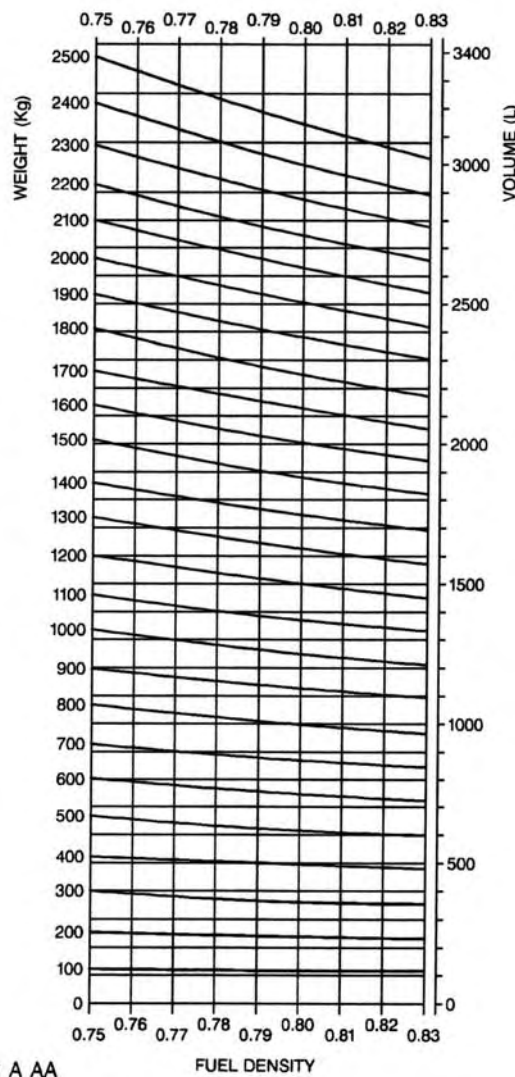

SJ5 284281 CHK 00110 001 A AA

Figure 28-42-81-CHK-00110-001 - VOLUME/WEIGHT CROSSCHECK OF FUEL QUANTITY

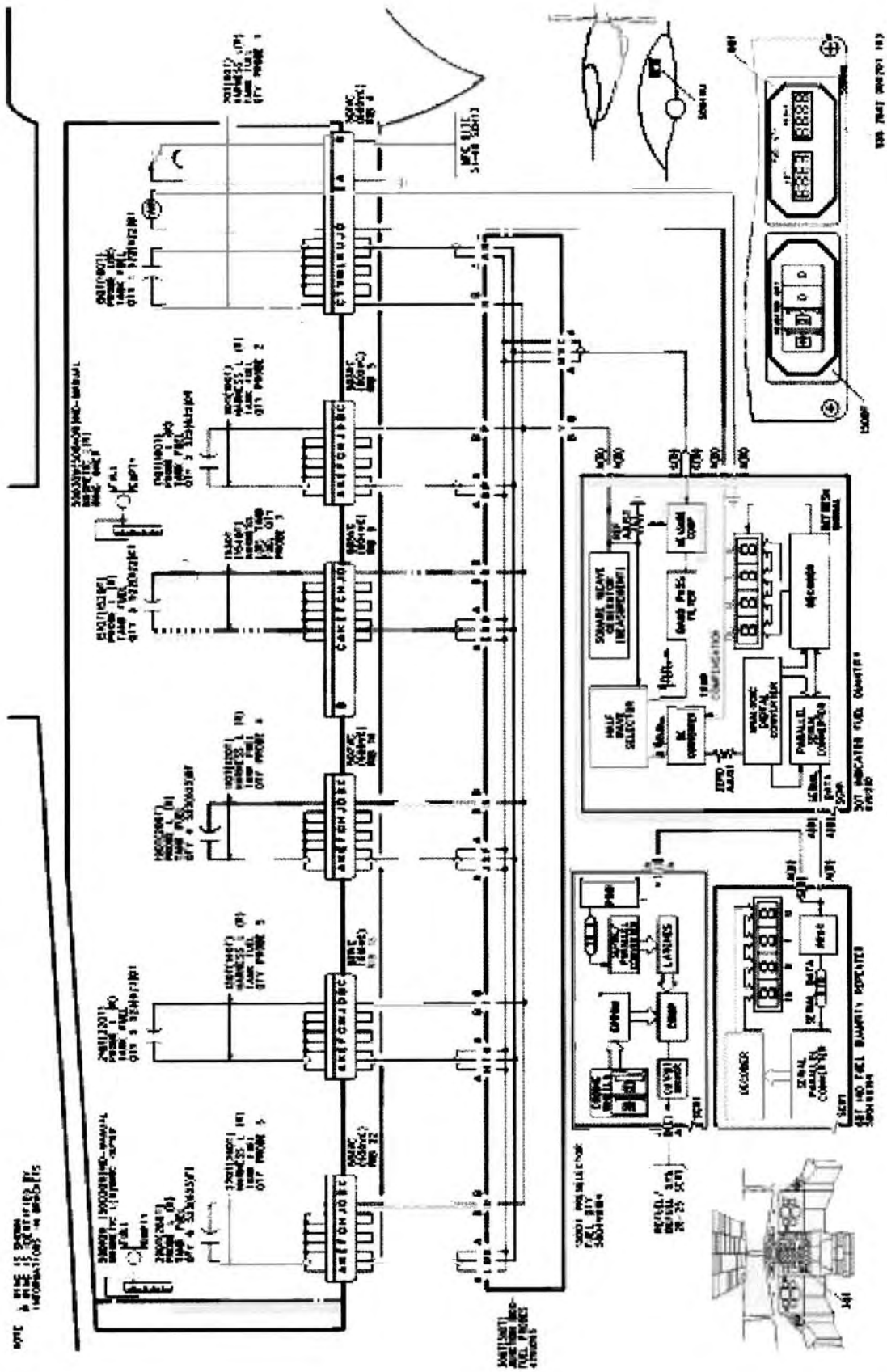

ATR-72 Fuel Quantity Indicator Electrical System (Schematic)



ATR 42 (kg)



ATR 72 (kg)

Maximum fuel quantity



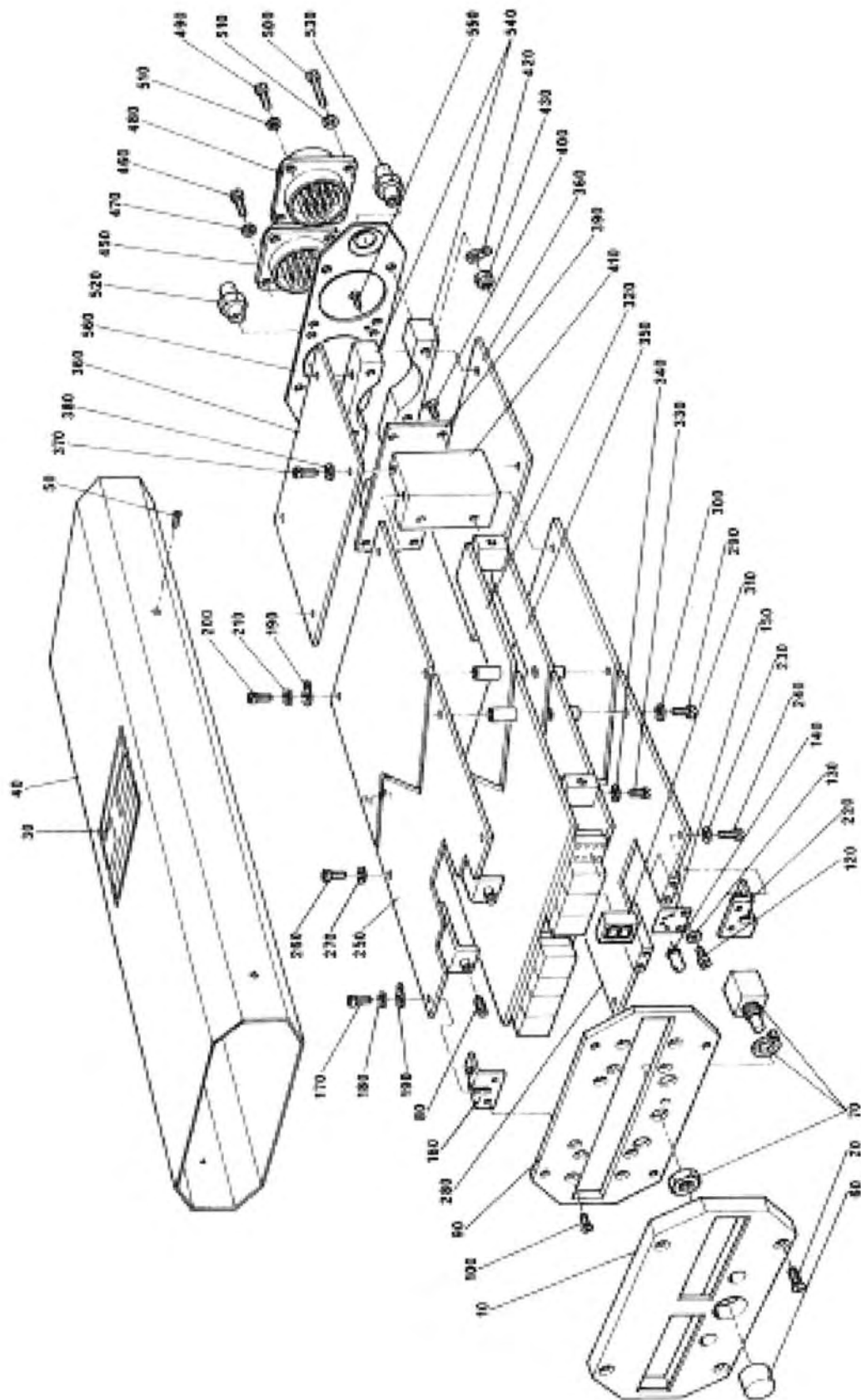

FQI - details

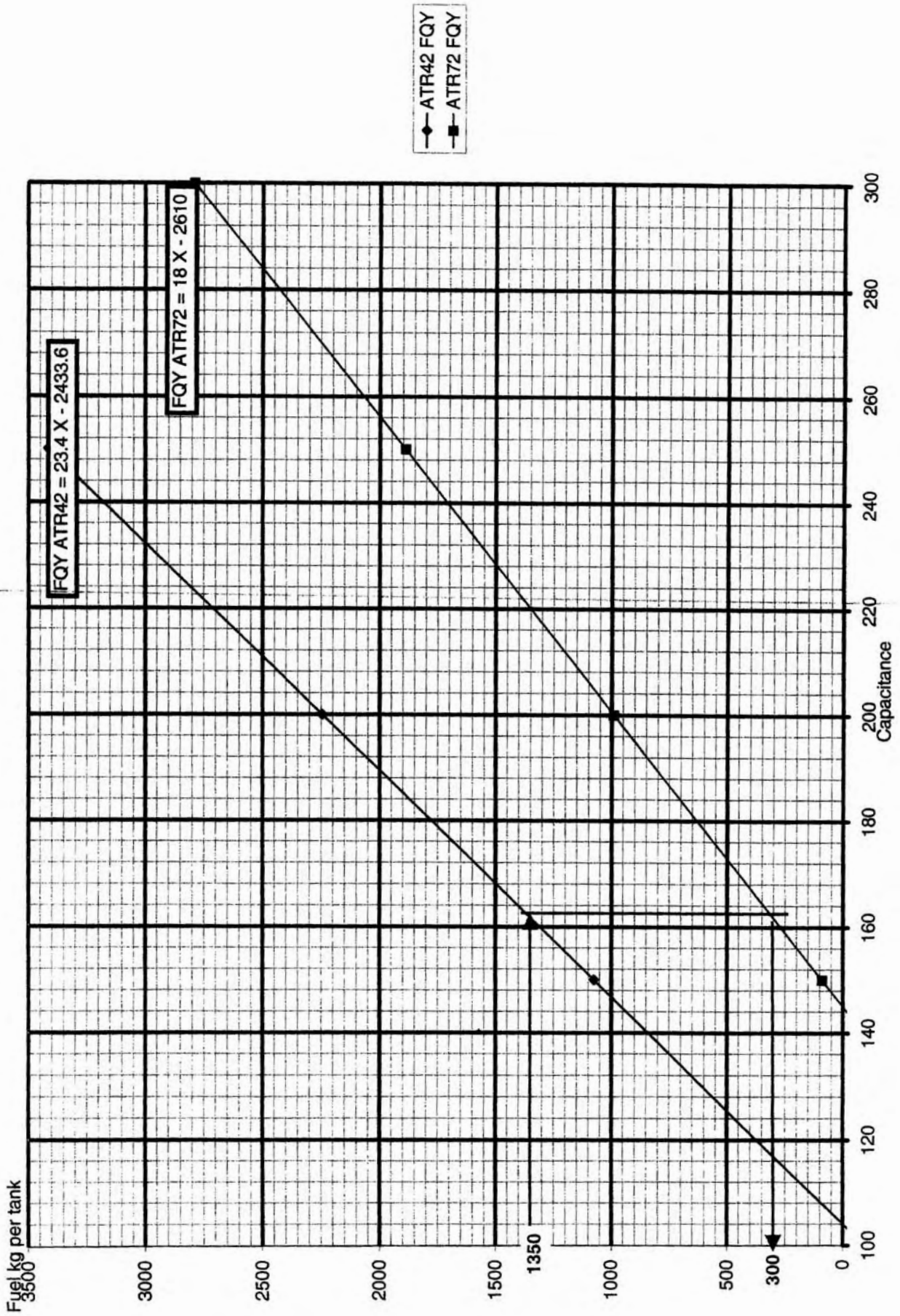

**INTERTECHNIQUE
COMPONENT MAINTENANCE MANUAL WITH I.P.L.
FUEL QUANTITY INDICATOR P/N 748-XXX**

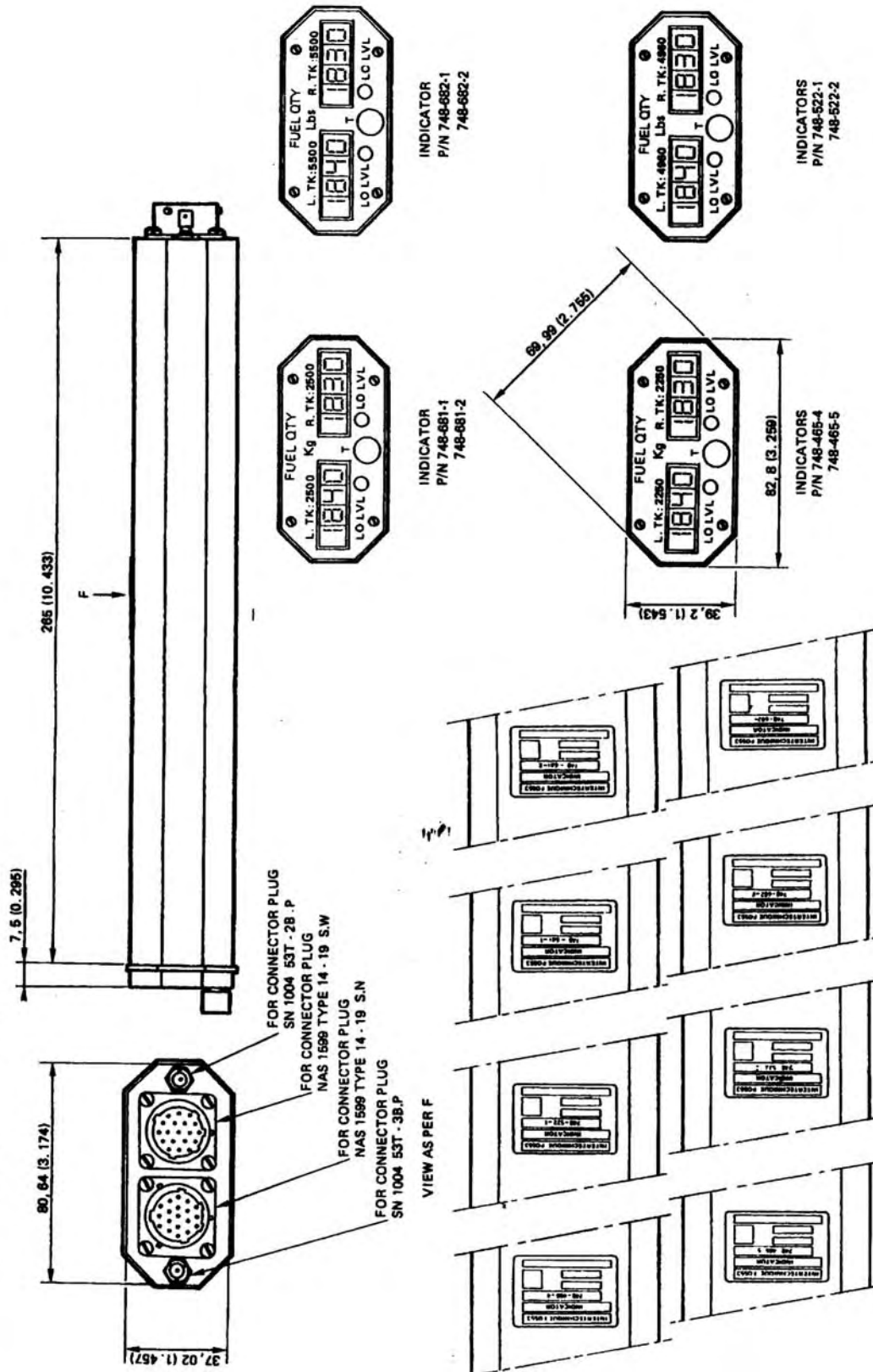

Overall dimensions
Figure 1

28-42-81
Page 3/4
OCT. 15/90



**INTERTECHNIQUE
COMPONENT MAINTENANCE MANUAL
749 SERIES**

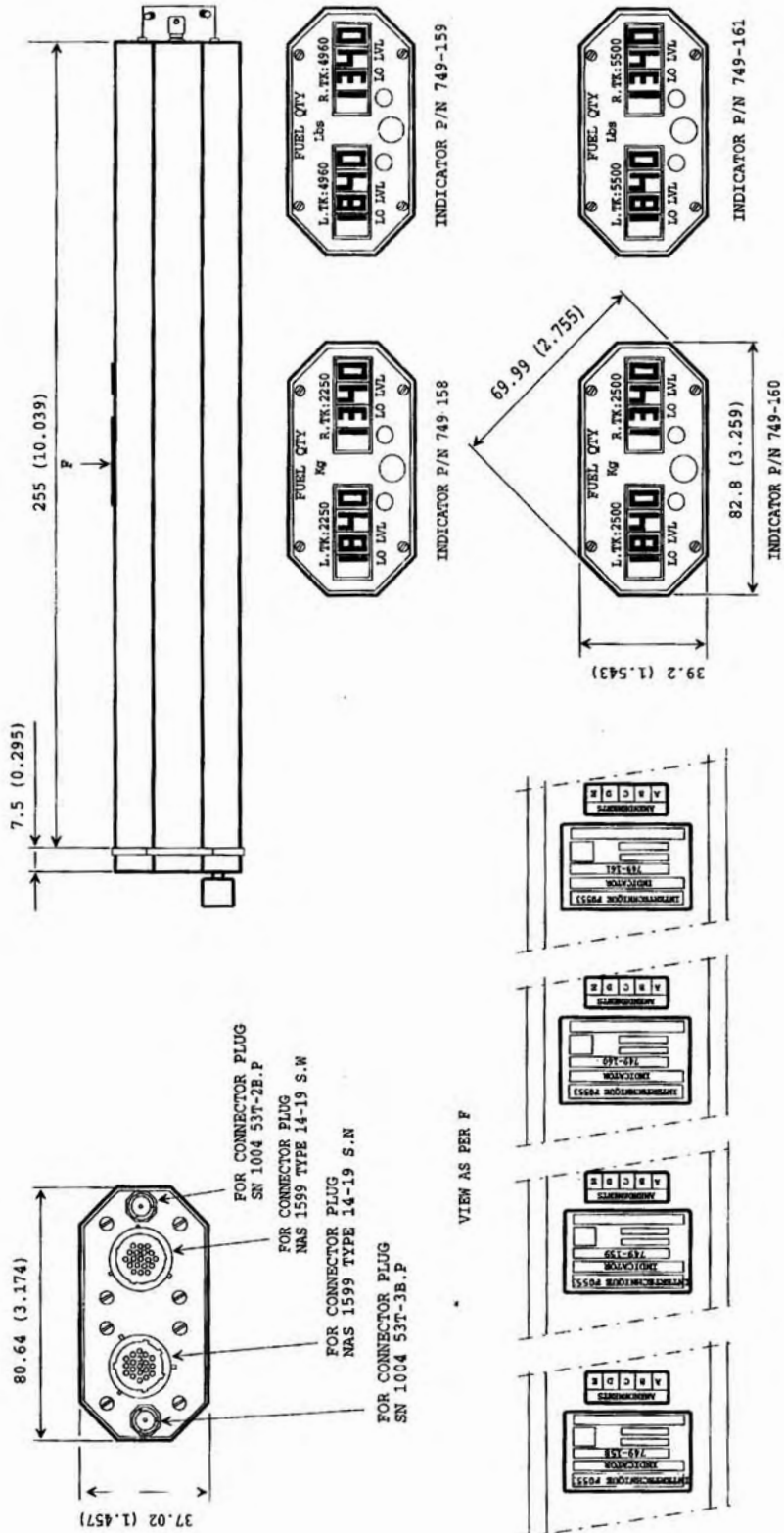

OVERALL DIMENSIONS
FIGURE 1

Page 3/4
JUL 15/99

28-42-82

The data and information contained herein are proprietary to INTERTECHNIQUE. Copy and distribution to a third party are strictly forbidden.

ATTACHMENT D

Safety recommendations already issued by ANSV and BFU

Ref. 1917 / INV / 443 / 5 / 05
Rome, 6 September 2005

SAFETY RECOMMENDATION

Subject: ATR-72, registration marks TS-LBB. Accident occurred on 6 August 2005 offshore Palermo airport (Sicily - Italy).

To: **EASA – European Aviation Safety Agency**
Executive Director – Mr Patrick Goudou
Postfach 10 12 53
D-50452 Koeln, Germany

c.c. **ENAC – Ente Nazionale per l'Aviazione Civile**
President - Prof. Vito Riggio
Viale del Castro Pretorio, 118 – 00185 Roma

On August 6, 2005, a ATR-72-202, registered in Tunisia as TS-LBB and operated by Tuninter as a non-scheduled flight (TUI 1153) from Bari (Italy) to Djerba (Tunisia), experienced a dual engine failure and ditched offshore Palermo (Sicily - Italy).

Airplane took off from Bari at 12.32 UTC with 39 persons on board (35 passengers, 4 crew). 45 minutes after, while cruising at FL 230, the crew experienced the right engine (n. 2) failure and decided to divert to Palermo Punta Raisi airport with only one engine operating. After 3-4 minutes, during the descent required by the operational condition at 17,000 ft ca, left engine (n. 1) also failed. The crew reported that they attempted to relight the engines with no success. After gliding for about 16 minutes, the aircraft was flown to a ditching procedure at approximately 23 NM North-East offshore from Palermo airport. The aircraft broke into three parts at impacting the sea surface. 15 passengers and 1 flight assistant reported fatal injuries; other occupants reported serious and minor injuries.

The aircraft technical documentation available at this stage of the investigation and the wreckage examination, showed that the Fuel Quantity Indicator (FQI) installed in the cockpit of the ATR-72,

registration marks TS-LBB, was an Intertechnique P/N 749-158, which is one of those applicable to the ATR-42 model.

The FQI provides the crew with the indication of the weight of the fuel contained in each wing tank. The FQI processes the signal coming from the capacitance probes installed in the tanks with an algorithm typical for each aircraft, depending on tank shape and size, and number of the probes installed.

The wing tanks of the ATR-72 and ATR-42 differ in terms of maximum fuel capacity and shape, as well as number of the probes; as a consequence FQIs for the ATR-72 and for the ATR-42 utilize different algorithms to process the input capacitance signals coming from the tank probes and therefore they are not interchangeable (see manufacturer curves in Annex).

Nevertheless the FQIs for the ATR-72 and ATR-42 have the same dimensions and installation interface; this means that an FQI for the ATR-42 could erroneously be installed on a ATR-72 model and viceversa. The only visible difference between the two FQIs is the indication in small white digits of the maximum fuel quantity per tank, which is “2500” for the ATR-72 and “2250” for the ATR-42.



Fuel Quantity Indicator ATR-42



Fuel Quantity Indicator ATR -72

ANSV conducted extensive refuelling tests in order to quantify and assess the effect of an erroneous FQI installation in terms of fuel quantity indication.

More specifically, for a given fuel quantity in the tanks of an ATR-72, FQI readings of an ATR-72 and ATR-42 model have been recorded.

Test results showed that a FQI for the ATR-42 installed on a ATR-72 introduces a non conservative error (i.e. the indicated values of the fuel quantity is greater than the fuel actually present on board),

which is linearly increasing with the fuel quantity and not less than 900 kg per tank; this means that with zero fuel on board the FQI ATR-42 readings for each tank is 900 kg (e.g. total fuel on board indicated by the FQI is not less than 1800 kg, see figure in Annex).

Based on the above considerations ANSV, still deeply investigating the occurrence, for the time being recommends that European Aviation Safety Agency:

- should require an ATR-72 and ATR-42 fleet inspection in order to verify the installation of the applicable Fuel Quantity Indicator.

(In reply refer to: ANSV-6/443-05/1/A/05).

- should consider the possibility to mandate a modification of the Fuel Quantity Indicator installation in order to prevent any incorrect fitting.

(In reply refer to: ANSV-7/443-05/2/A/05).

Original signed
Prof. Bruno Franchi
ANSV President

ANNEX

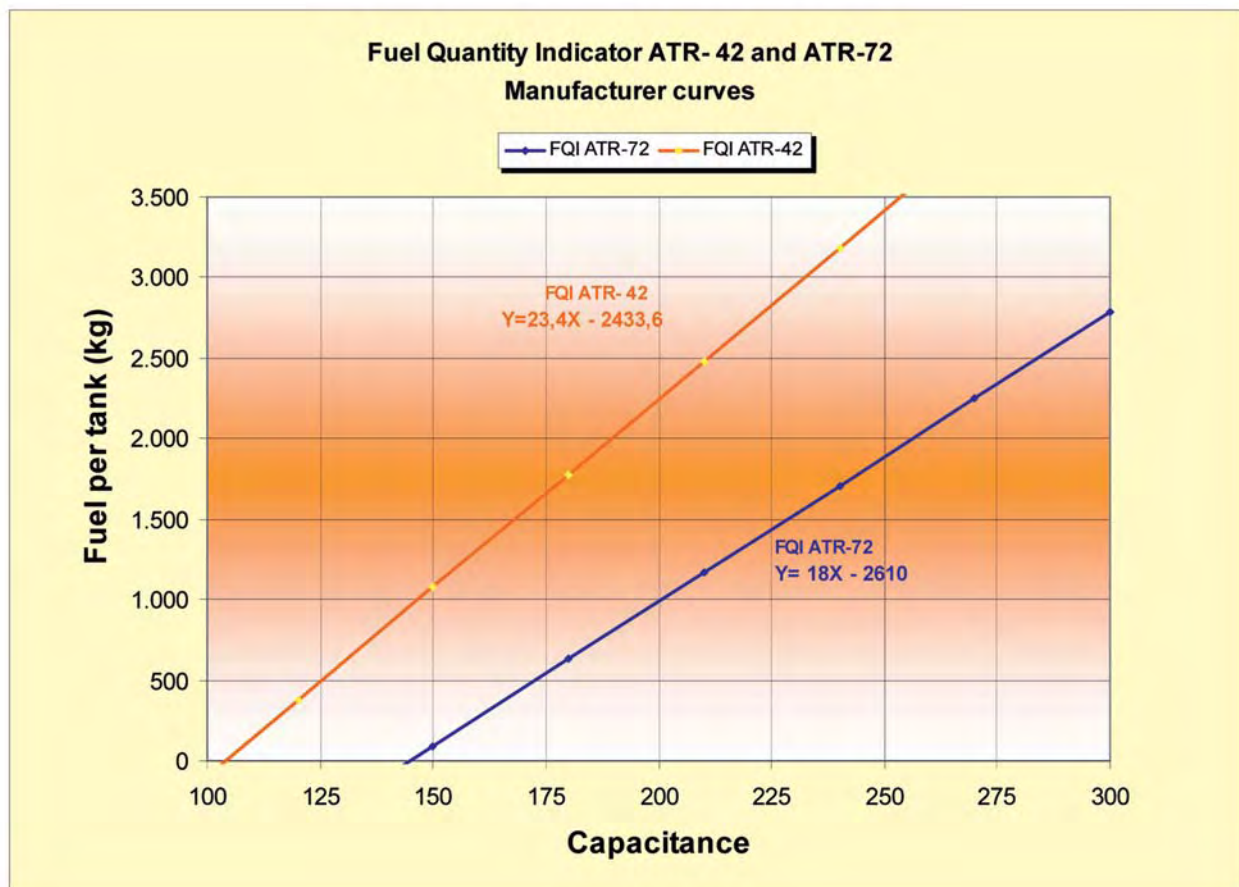

ANNEX

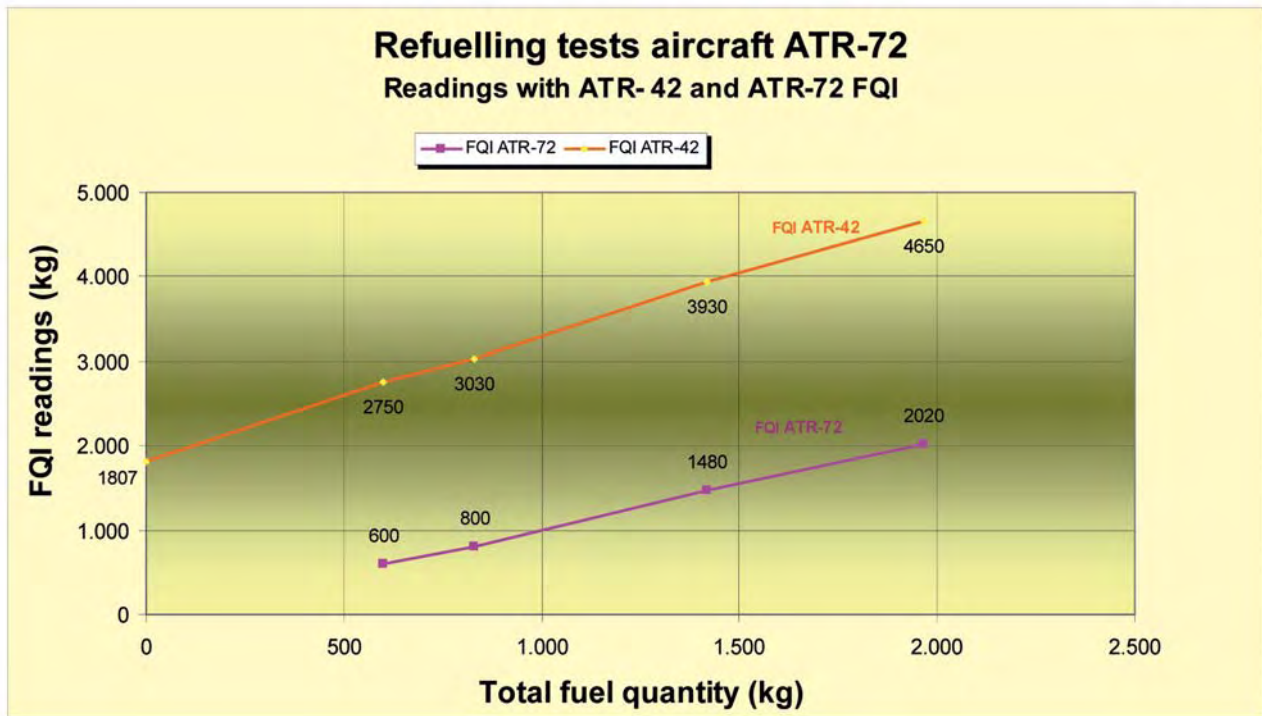

Ref. 2818/INV/443/5/05
Rome, **5 DIC. 2005**

SAFETY RECOMMENDATION

Subject: ATR 72, registration marks TS-LBB. Accident occurred on 6 August 2005 offshore Palermo airport (Sicily – Italy).

To: **EASA – European Aviation Safety Agency**
Executive Director – M. Patrick Goudou
Postfach 10 12 53
D-50452 Koeln, Germany

c.c. **ENAC – Ente Nazionale per l'Aviazione Civile**
President - Prof. Vito Riggio
Viale del Castro Pretorio, 118 – 00185 Roma

As a result of the evidences collected during the initial phase of the technical investigation on the subject accident, on 6 September 2005 ANSV issued the safety recommendations ANSV-6/443-05/1/A/05 and ANSV-7/443-05/2/A/05.

In the meantime this Agency pursued the investigation on the event in order to determine its causal and contributory factors.

The analysis of the additional information gathered at this stage of the investigation allowed a better understanding of the event.

Based on the available evidences, such as the information on the aircraft refuelling operations, the logbook entries, the fuel used during the previous flight TUI 152F from Tunis to Bari and during the flight TUI 1153 from takeoff to ditching, it has been possible, in particular, to determine the fuel quantity actually present in the tanks and the fuel quantity information provided to the crew by the cabin instruments during the various phases of the last two flights.

The attached figure shows the result of this analysis.

Note: for coherence with the data in the figure, a single fuel low level activation line has been drawn at 320 kg. In fact, as specified in the text, each tank has its own fuel low level alerts system which activates when the fuel in the tank is less than 160 kg.

As shown in the attached figure, the actual total fuel tanks contents after the uncommanded double engine flame-out was 0 kg, even though the Fuel Quantity Indicator (FQI) was indicating 1.800 kg (900 kg in each wing tank). Tests confirmed that with no fuel in the tanks of an ATR 72 aircraft, the indication provided by a FQI applicable to the ATR 42 model, installed on it, is exactly 1.800 kg.

The figure shows that the estimated total fuel onboard after landing at Bari airport was about 305 kg, however the FQI indication was about 2.300 kg; the crew confirmed this indication during the interviews conducted by ANSV. In the same occasion the crew stated that during the accident flight and the previous one they did not get any fuel low level alerts.

In the FQI panel there are two amber lights (with a white inscription “LO LVL”) which, separately for the LH and RH tank, provide the crew with a visual alert in case of low fuel contents; an aural alert (chime) is associated to the visual one, together with the activation of the Master Caution.

According to the system logic, the amber LO LVL light illuminates when fuel content in the tank is less than 160 kg; this information is provided by the FQI instrument, which, based on the inputs coming from the capacitors installed in the wing tanks, calculates the fuel quantity utilizing an algorithm depending on the fuel tank shape, its dimensions and the number of capacitors installed.

In other terms, the fuel low level warning system of the aircraft ATR 72 registration marks TS-LBB was directly linked to the fuel quantity gauging system, since the activation of the visual and aural alerts is controlled by the FQI instrument. This is applicable to the ATR 42-200 and -300 as well.

As a consequence, in this case, even though the actual fuel quantity in each tank during the flight from Tunis to Bari and from Bari to Palermo lowered below 160 kg (see the attached figure), the low fuel quantity warnings did not activate.

The FQI instrument applicable to the ATR 42 model, installed on the ATR 72 aircraft registration marks TS-LBB, calculated and indicated a fuel quantity at least 900 kg greater than the actual one, and, in accordance with the system logic, did not trigger the fuel low level alerts.

The Certification Specification 25 “Large Aeroplanes” (superseding JAR-25), applicable to the ATR 42 and ATR 72 type, as well as the Certification Specification 23 (applicable to a different class - *normal, utility, aerobatic & commuter aeroplanes*), with regard to the fuel system, do not specifically require the installation of a fuel low level warning system independent from the fuel gauging system.

It is to be noted that there are aircraft certified in accordance with CS-25 adopting a fuel low level warning independent from the fuel gauging systems.

In 2002 ATR issued the Service Bulletin ATR72-28-1013 (Title: Fuel – Quantity Indication – Add low level detection system), applicable to ATR 72-202, when used in ETOPS operations.

Based on the above considerations ANSV recommends that European Aviation Safety Agency:

should consider the possibility to change the fuel system certification regulation for public transport aircraft, in order to require that the fuel low level warnings be independent from the fuel gauging systems.

(In reply refers to: ANSV-13/443-05/3/A/05).

Original signed
Prof. Bruno Franchi
ANSV President

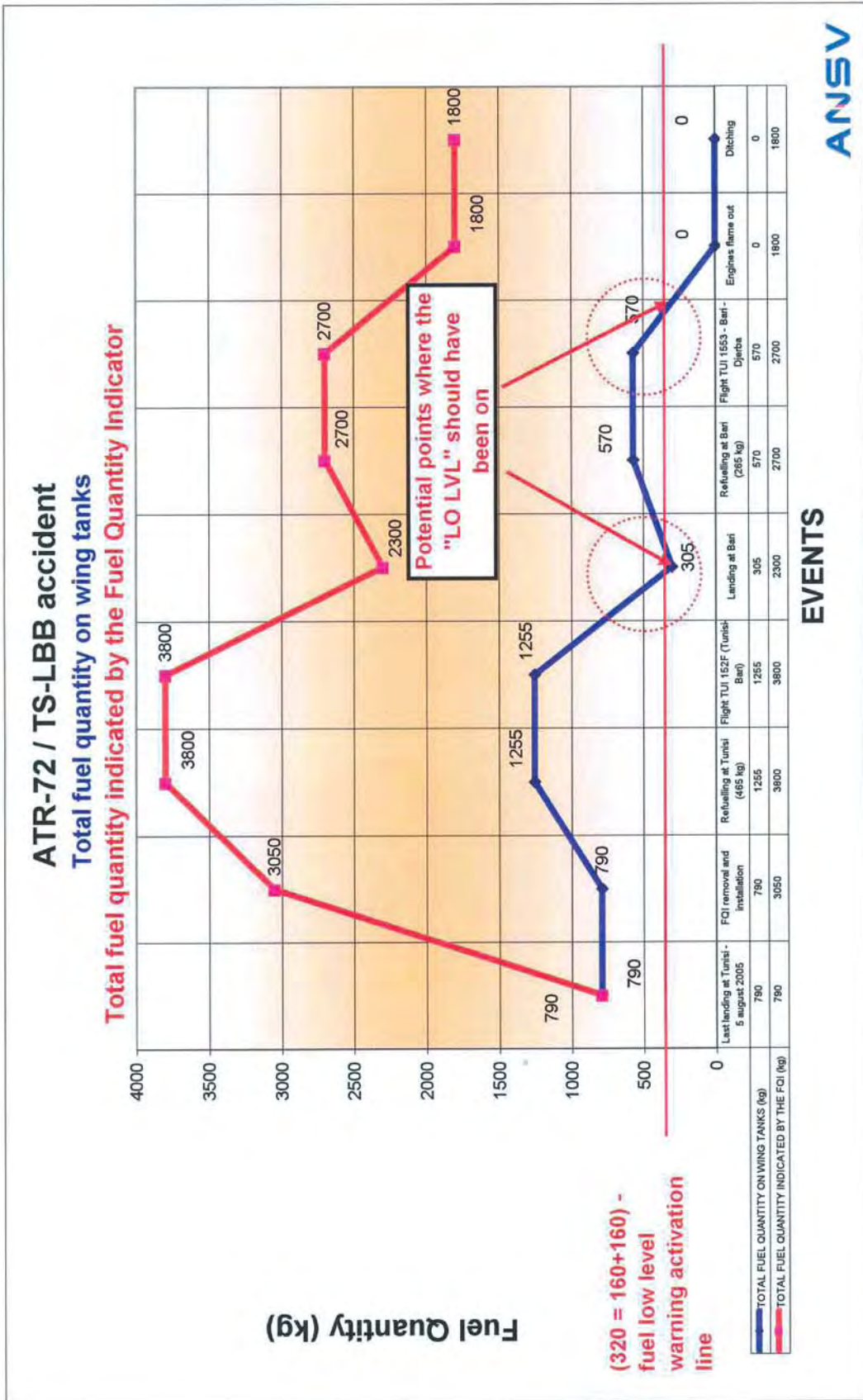

Bundesstelle für
Flugunfalluntersuchung
German Federal Bureau of
Aircraft Accidents Investigation

Safety Recommendation

14/2006
25 October 2006

To EASA

Installation of a wrong Fuel Quantity Indicator in an ATR 72

Factual information

Incident: 5X011-0/06

On 18 March 2006 at about 08:50 hrs local time during flight preparations for the flight from Duesseldorf to Dresden, the ATR 72 crew noticed a difference of about 1,800 kg fuel between the remaining fuel quantity after the last flight and the currently indicated one. Because there was no explanation and no fuelling order the crew objected the flight and insisted that the matter was looked into.

Maintenance checked the aircraft and determined that a Fuel Quantity Indicator (FQI) of an ATR 42 had been installed during the previously performed maintenance work. This FQI indicated a fuel quantity which was about 1,800 kg higher as the actual one.

The investigation of the company involved, Contactair, determined that the mechanic in Duesseldorf had noticed the different FQI part numbers (P/N). P/N of the removed FQI: 749-759. P/N of the FQI to be installed: 749-757. He asked the Home Base in Saarbruecken and received the answer that the two P/Ns are interchangeable.

In retrospect it was determined that the two people had spoken about two different replacement parts. Whereas the mechanic talked about the FQI the colleague at the Home Base spoke of the Fuel Probes in the fuel tanks. These are indeed interchangeable whereas the FQIs are not.

One can easily replace or interchange the FQI of the two aircraft types (ATR 72 and 42) because they are identical in construction. The only difference lies in the imprinted fuel quantities of the left and right fuel tanks: ATR 42 – 2250 kg, ATR 72 – 2500 kg. This imprint does not really catch the eye and is easily overlooked.

Contactair contacted ATR's Airworthiness- and Safety-Department as well as EASA with the request to change the construction so that in the future these FQIs cannot be installed in the wrong aircraft type.

The company, thereby, referred to a safety recommendation issued by the Italian Air Accident Investigation Authority – ANSV. This safety recommendation was addressed to ATR and EASA in connection with an accident in 2005 with Tuninter where a wrong FQI was a relevant cause for the accident.

ATR and EASA objected to the construction change.

ATR advised Contactair in writing with so called „Points of detection“ how this mistake could have been prevented and stated that the existing provisions were sufficient.

Analysis

The reoccurrence of an interchange of the two FQI's (installation of FQI 42 instead of FQI 72) makes very clear that the safety recommendation issued by ANSV after the Tuninter accident to change the construction of the FQIs is still valid.

Recommendation

Recommendation no.: 14/2006

EASA should arrange that the construction of one of the Fuel Quantity Indicators (FQI) of the ATR 72 or ATR 42 be changed to such an extent that they cannot be interchanged anymore.

Kramer

Director of the BFU



European Aviation Safety Agency

Safety Recommendation Reply

Recommendation 2006-014 issued on 11.12.2006

Subject:	Incident to ATR72, on 18.03.2006 at Dusseldorf airport
Safety recommendation:	EASA should arrange that the construction of one of the Fuel Quantity Indicators (FQI) of the ATR 72 or ATR 42 be changed to such an extent that they cannot be interchanged any more.
Response category:	Partial Agreement
Response:	<p>EASA has brought this event to the TC holder's knowledge. This event emphasizes the ANSV recommendation related to the ATR72 accident registered TS-LBB on August 2005 near the Italian coast. In such occasion, it was validated that the current aircraft Type Design meets the certification requirements, the involved fuel quantity indicators have different part numbers and the maintenance instructions/documentation from the TC Holder takes this into account (In both events, it appears that the maintenance procedure was not strictly followed).</p> <p>Consequently, some additional actions were put into practice:</p> <ul style="list-style-type: none"> • ATR distributed among the operators several "All Operators Messages" regarding this event; • EASA as well as other Civil Aviation Authorities issued specific Airworthiness Directives to perform a one shot inspection on the fuel quantity indicators for all ATR42 and 72. <p>However, in the light of this new occurrence, a new risk assessment will be performed through specific meetings between EASA Certification Team and ATR.</p>
Status:	Open

ATTACHMENT E

ATR 72 fuel system, FCOM extracts

	FUEL SYSTEM CONTENTS	1.11.00		
		P 1	001	
				DEC 96

AA

1.11.00 CONTENTS

1.11.10 GENERAL

- 10.1 DESCRIPTION
- 10.2 CONTROLS
- 10.3 ELECTRICAL SUPPLY/SYSTEM MONITORING
- 10.4 LATERAL MAINTENANCE PANEL
- 10.5 SCHEMATIC

	FUEL SYSTEM	1.11.10		
		P 1	001	
	GENERAL			DEC 96

AA

10.1 DESCRIPTION

The fuel system includes :

- two tanks with one electrical pump and one jet pump in each tank
- the vent system
- the fuel quantity indicating system
- the refuel/defuel system with associated controls and ind.

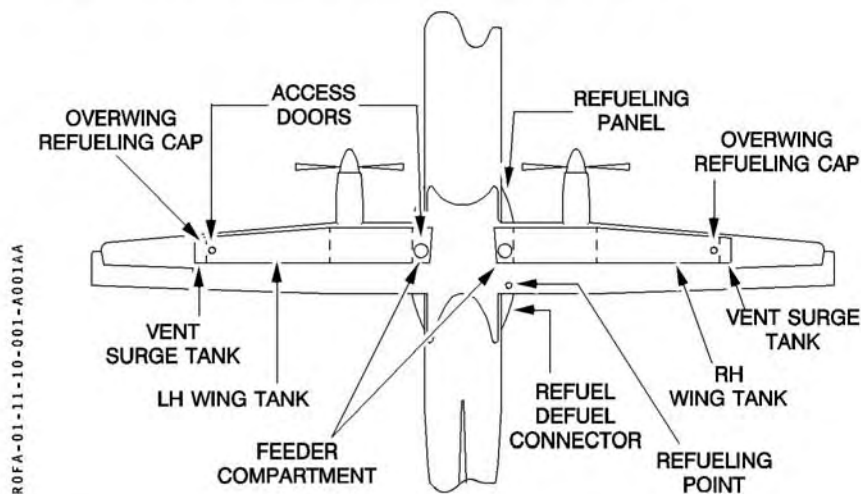

TANKS

The fuel is stored in two tanks, one in each wing, formed as an integral part of the wing structure. The maximum fuel capacity is :

	per tank	total
Volume	3185 l (840 US gal)	6370 l (1680 US gal)
Weight (density 0,785)	2500 kg (5512 lbs)	5000 kg (11025 lbs)

An additional volume in each tank allows a 2 % thermal expansion of fuel without spillage.

Each tank is equipped with two access doors located on the upper wing skin at each tank extremity to provide access to the interior and to essential equipment.

Water drainage is provided at the low points of each tank and can be performed up to 3° ground slope.

A temperature measuring device is installed in the left feeder compartment. Temperature is displayed on the pilot panel.

	FUEL SYSTEM		1.11.10		
	GENERAL		P 2	001	
					DEC 96

AA

VENT SYSTEM

TANKS

The vent system ensures positive pressure in the whole flight envelope. Each fuel tank is air vented via an individual vent duct and a vent float valve to a 100 l surge tank located in the outer section of the wing. The surge tank is connected to the atmosphere via a flush NACA inlet and is designed to avoid icing obstructions. Fuel collected in the surge tank is directed back to the wing tank via the vent duct.

The vent system also provides protection for the tanks in the event of accidental spillage during refueling.

WING CENTER BOX

The wing center box over the fuselage does not store any fuel and is crossed by two fuel pipes for cross engine feed and tanks refueling. To prevent fuel vapor concentration, the box is vented and drained.

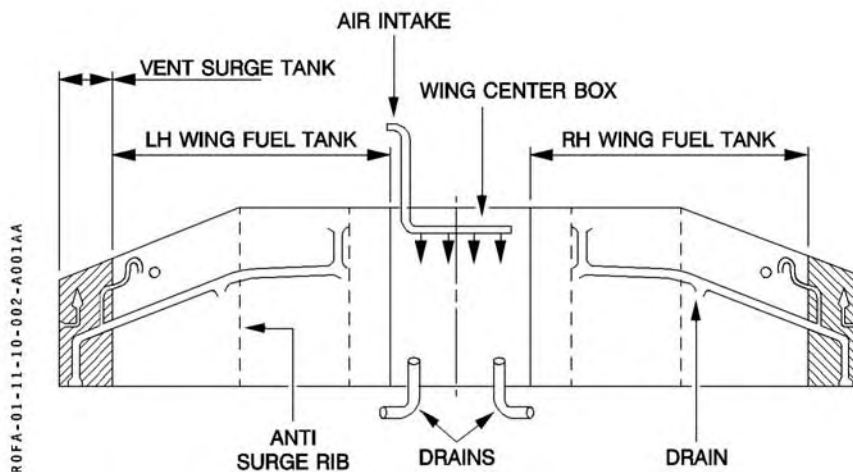

	FUEL SYSTEM	1.11.10		
		P 3	001	
	GENERAL			DEC 96

AA

ENGINE FEED (See schematic p 13/14)

In normal conditions, each engine is supplied from its associated wing tank. Fuel flow/fuel used ind. allow the crew to monitor fuel consumption for each engine.

Each tank is fitted with a 200 l feeder compartment always full of fuel protecting the engine feed system against negative or lateral load factors. In the feeder compartment, an electrical pump and a jet pump are installed. The jet pump is activated by HP fuel from the engine HMU and is controlled by a motive flow valve.

Note : Each electrical pump is able to supply one engine in the whole flight envelope.

In normal operation, the electrical pump is only used to start the engine. After start, jet pump takes over automatically.

If jet pump pressure drops below 350 mbar (5 PSI), the electrical pump is automatically activated to supply the engine.

A crossfeed valve, controlled by an electrically operated actuator, allows both engines to be fed from one side or one engine to be fed by either tank, allowing control of an unbalance situation.

When the crossfeed valve is open, a blue "FUEL X FEED" light comes on memo panel.

In this case, the two electrical pumps are automatically actuated. It's possible to use only one fuel tank by switching off the opposite pump pb.

At the fuel outlet of each tank a fuel LP valve, controlled by the associated fire handle, is installed.

When low level is reached in one tank, its electrical pump is automatically actuated (\leq 160 kg remaining fuel in the tank).

 NR72 F.C.O.M.	FUEL SYSTEM		1.11.10	
	P 4	001		
	GENERAL		DEC 96	

AA

QUANTITY INDICATING

The fuel tank capacity measurement system is such that the figures appear in terms of weight. The system is based on the fundamental relationship between the dielectric constant of the fuel and its density, to obtain a signal proportional to the mass of fuel in the tanks from a number of capacitance probes installed in the tanks.

Six probes are positioned in each tank and are electrically connected to the cockpit fuel quantity ind. Both fuel quantity indicating channels (one per tank) are independent. The fuel quantity ind. contains two digital displays showing the fuel mass in each of the two tanks. The accuracy on the total fuel indication, on ground, with attitude within -3° and $+1^\circ$ of Pitch and $\pm 2^\circ$ of Roll is :

$\pm 1\%$ of full scale near zero level

$\pm 3\%$ of full scale at full level

For all other ground and flight conditions, outside this envelope (pitch and roll) accuracy of fuel indications will be degraded.

To enable the tanks content to be determined on the ground in case of quantity indicating system failure, two magnetic level indicators are mounted in each tank through the lower wing skin. Tables allow these readings to be converted into units of fuel mass with corrections made for aircraft attitude and fuel density (Refer to chapter 2.06).

Actual magnetic indicators marking is in cm of fuel in the tank.

REFUEL/DEFUEL SYSTEM

All refueling operations are controlled from the refueling panel installed in the RH main landing gear fairing.

Complete refueling can be achieved in about 16 mn through the single refueling connector which is located in the rear part of the RH main landing gear fairing. Both wing tanks can be refueled with a refueling flow of about $24 \text{ m}^3/\text{h}$ (106 US gal/mn) with a maximum refueling pressure of 3.5 bars (50 PSI).

From the valve outlet, the fuel is distributed by pipes to diffusers which allow the fuel to enter the tank without surging.

High level detection comprises two different controls :

In normal operation, the high level detection is achieved by the FQI System. When the high level tank quantity is reached (2500 kg/5510 lb), the associated tank refuel valve is shut.

In case of FQI detection failure, the high level detection is achieved by a level sensor installed at the bottom of each surge tank.

When this level sensor is activated (3185 l/840 us gal), the associated high level light is illuminated on the refuel panel and the corresponding refuel valve is shut.

The wing tanks can also be refueled by gravity via one top of wing filler CAP per tank. The system may be used to defuel the aircraft by applying a 0.77 bar (11 PSI) suction to the connector and opening the tank refuel valves.

	FUEL SYSTEM	1.11.10		
		P 5	001	
	GENERAL			DEC 96

AB

10.2 CONTROLS

FUEL PANEL

PROFA-01-11-10-005-A001AA

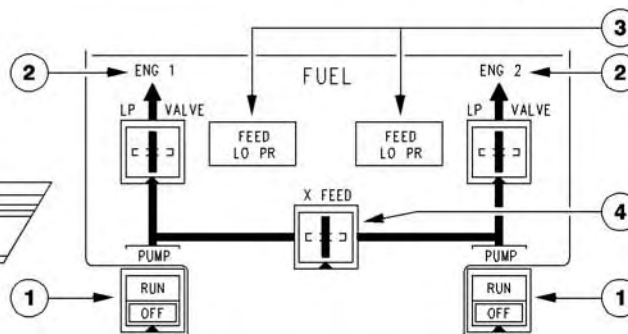

① PUMP pb

Controls electrical pump and jet pump motive flow valve in each tank.

PB pressed in :

- * when jet pump delivery low pressure is detected (engine not running or jet pump pressure drop) :
 - electrical pump is automatically activated,
 - jet pump motive flow valve is controlled open but will remain closed until a sufficient pressure is available.
- * as soon as HP fuel pressure is available and normal jet pump functioning is sensed by the 600 mbar (8.5 PSI) pressure switch, electrical pump is automatically switched off.

RUN illuminates green when electrical pump is activated.

OFF (pb released) electrical pump is deactivated, jet pump motive flow valve is controlled closed, OFF It illuminates white.

② LP VALVE position ind.

The position of the fuel LP valve is displayed. Each valve is controlled by its associated fire handle.

IN LINE Flow bar illuminates green. The valve is open.

CROSS LINE The valve is closed, flow bar illuminates green and crosses the system flow line.

Note : During transient phases (opening or closing), flow bars are extinguished.

③ FEED LO PR light

The light illuminates amber and the CCAS is activated when the fuel delivery pressure drops below 350 mbar (5 PSI). This indicates pump failure or fuel starvation.

④ X FEED pb

Controls the operation of the fuel crossfeed valve.

IN LINE (pb pressed in) The flow bar illuminates green in line. The valve is open.

Both electrical pumps are automatically actuated.

CROSS LINE (pb released) The flow bar illuminates green and crosses the system flow line. The valve is closed.

Note : During transient phases (opening or closing), flow bar is extinguished. Permanent extinguishing of both bars indicates a valve fault.

Eng. : PW124

	FUEL SYSTEM	1.11.10	
		P 6	001
	GENERAL		JUL 98

AA

FUEL QTY PANEL

R0FA-01-11-10-006-A001AA

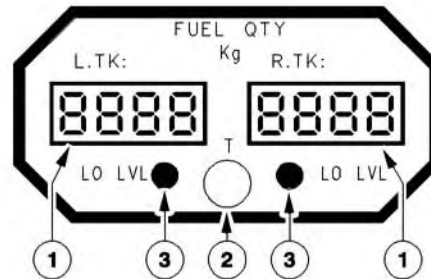
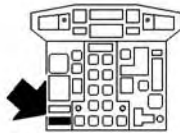

- ① **FUEL QTY indications**
Fuel quantity in each tank is displayed in kg.
- ② **Test pb**
Pressing the test button will check both measurement channels and, if the functioning is normal, display all 8's.
At the same time, CCAS is activated, MC flashes amber, SC is heard.
- ③ **LO LVL amber lights**
Each light illuminates amber and the CCAS is activated when quantity of the concerned display becomes lower than 160 kg ; in addition, the corresponding electrical pump is automatically actuated.

FF/FU IND.

R0FA-01-11-10-006-B001AA



- A fuel flow/fuel used ind. is provided for each engine.
- ① **FF indication**
The mass fuel flow to the engine is indicated by a pointer on a scale graduated in kg/h X 100
 - R ② **FU counter**
On the digital read out, fuel used is indicated in kg. This value is computed by integration of the fuel flow parameter.
 - ③ **FU reset knob**
The fuel used counter is reset to 0 by pulling associated ind. reset knob.
- Note :** All the digits (on the FU counter as well as on the FUEL QTY ind.) may be tested by the overhead panel ANN LIGHT switch on TEST position.

	FUEL SYSTEM	1.11.10		
		P 7	001	
	GENERAL			JUL 01

AA X FEED advisory light

ROFA-01-11-10-007-A001AA

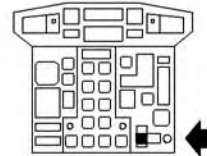

Illuminates blue on memo panel when the crossfeed valve is selected open.
TANK FUEL TEMPERATURE INDICATOR

ROFA-01-11-10-007-B001AA

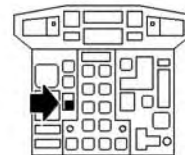

A temperature measuring device is installed in the left feeder compartment.
 Temperature is displayed on the center instrument panel.
FUEL TEMP IND

ROFA-01-11-10-007-C060AA

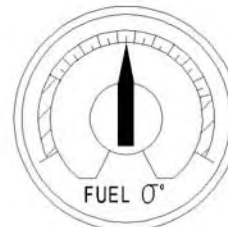
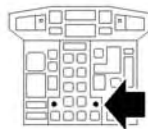

FUEL TEMP indication

Fuel temperature is displayed.

- R Yellow sector : -54°C to 0°C
- R Green sector : 0°C to 50°C
- R Yellow sector : 50°C to 57°C
- Red dash : -54°C and + 57°C

FUEL CLOG LIGHT

FUEL CLOG

Light illuminates amber when fuel pressure loss in the corresponding HP pump fuel filter exceeds 45 PSI, indicating that the filter is blocked and by passed.

	FUEL SYSTEM		1.11.10	
	GENERAL		P 8	001
			DEC 96	

AA

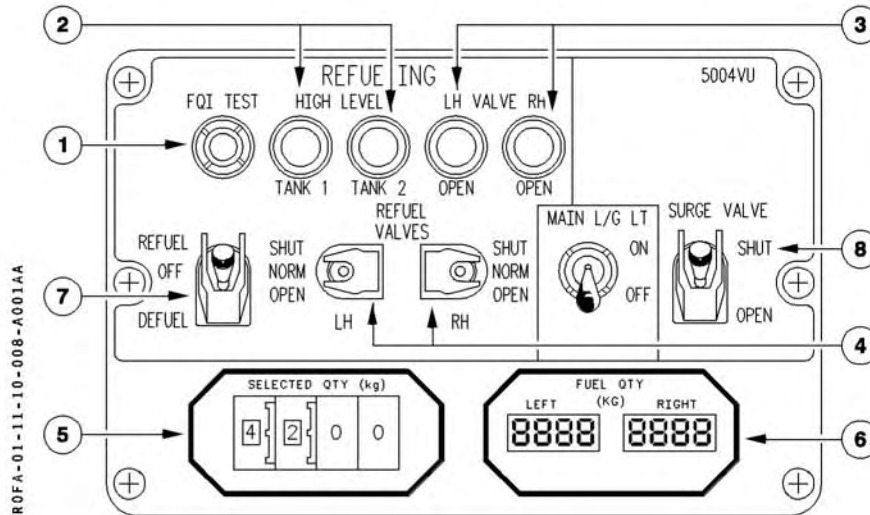
REFUELING PANEL

- ① **FQI TEST pb**
Pressing the test button will check both measurement channels and, if the functioning is normal, display all 8's on the FUEL QTY ind. on the refueling panel as well as in the cockpit. It will also shut the refuel valves, simulating a maxi level in both tanks. This test activates the CCAS.
- ② **HIGH LEVEL light**
The light illuminates amber when the high level sensor is submerged (maximum refueling quantity reached). The corresponding refuel valve closes automatically.
- ③ **REFUEL VALVES position light**
The light illuminates blue when the refuel valve is open. They extinguish during the fuel circuit test, indicating the valves have closed.

	FUEL SYSTEM	1.11.10		
		P 9	001	
	GENERAL			DEC 96

AA

④ REFUEL VALVES switches

Control the operation of the valves for each tank. They are guarded at NORM.

NORM Valves are controlled by automatic fueling logic, depending on position of the mode selector switch and quantity preselection. Valves close automatically when high level is detected by the FQI.

OPEN Valves open when the mode selector switch is in the refuel or defuel position and the high level sensor is not submerged.

SHUT Valves close regardless of the mode selector switch position.

⑤ SELECTED QTY ind.

The quantity for automatic refueling is controlled by the setting of the preselector. The counter displays the preselected total fuel quantity.

⑥ FUEL QTY ind.

This ind. has the same presentation as the one used in the cockpit.

CAUTION : Wait indicators are stabilized before taking into account fuel quantity indications.

⑦ Mode selector switches

Controls the operating mode for automatic fueling and the activation of REFUEL VALVES switches for manual operation.

OFF Refuel valves are closed, switches are not activated.

REFUEL Refuel valves may be operated by auto refueling logic (REFUEL VALVES switches on NORM) or manual refueling operation.

DEFUEL Refuel valves may be operated by manual defueling operation. With the mode selector in DEFUEL position and REFUEL VALVES in the OPEN position, all level protections are inhibited.

⑧ SURGE VALVE

Provides air vent of the refuel line during suction draining of this line.

OPEN The surge valve opens. Mode Selector switch must be in OFF position

SHUT The surge valve is closed.

	FUEL SYSTEM	1.11.10		
		P 10	001	
	GENERAL			DEC 96

AA

10.3 ELECTRICAL SUPPLY/SYSTEM MONITORING

ELECTRICAL SUPPLY

EQUIPMENT	DC BUS SUPPLY (C/B)
ENG 1 Electrical pump – Pressure sw controlling electrical pump activation/ disactivation and motive flow valve opening/closure – Fuel feed pressure sw Fuel LP valve Fuel LP valve position ind. FF/FU ind.	DC ESS BUS (on lateral panel ELEC PUMP) DC ESS BUS (on lateral panel CTL and CAUTION) • DC BUS 1 (on lateral panel MOTOR 1) • DC EMER BUS (on lateral panel MOTOR 2) DC EMER BUS (on lateral panel IND) DC BUS 1 (on lateral panel FUEL FLOW FUEL USED)
ENG 2 Electrical pump – Pressure sw controlling electrical pump activation/ disactivation and motive flow valve opening/closure – Fuel feed pressure sw + IND Fuel LP valve Fuel LP valve position ind. FF/FU ind.	DC ESS BUS (on lateral panel ELEC PUMP) DC ESS BUS (on lateral panel CTL and CAUTION) • DC BUS 2 (on lateral panel MOTOR 1) • DC EMER BUS (on lateral panel MOTOR 2) DC EMER BUS (on lateral panel IND) DC BUS 2 (on lateral panel FUEL FLOW FUEL USED)

 A320 F.C.O.M.	FUEL SYSTEM	1.11.10		
		P 11/12	001	
	GENERAL			DEC 96

AB

EQUIPMENT	DC BUS SUPPLY (C/B)
Refuel valves high level detection System	GND HDLG BUS (on lateral panel FUELING CTL and IND)
Left quantity ind. *	DC ESS BUS (on lateral panel L TANK)
Right quantity ind. *	DC ESS BUS (on lateral panel R TANK)
Crossfeed valve	DC ESS BUS (on lateral panel X FEED)
Tank fuel temperature indicator	DC BUS 1 (on lateral panel)

* Left and right cockpit quantity indicators will be supplied by GND HDLG BUS on ground for airplane servicing, when battery is off and refuel door open.

SYSTEM MONITORING

The following conditions are monitored by visual and aural alerts :

- Engine feed low pressure (below 350 mbar/5PSI)
 - See FEED LO PR procedure in chapter 2.05.03.
- Fuel tank low level (below 160 kg/352 Lbs)
 - See FUEL LO LVL procedure in chapter 2.05.03.
- Jet pump pressure drop (below 350 mbar/5PSI)
 - this condition is monitored only by visual alert. RUN green light illuminates on overhead panel.

10.4 LATERAL MAINTENANCE PANEL

The right side maintenance panel includes a readout display for failures of systems linked to the MFC (refer to 1.01.10/10.5). It can be used to test feeder jet pumps functioning.

Eng. : PW124

	FUEL SYSTEM	1.11.10	
	DESCRIPTION	P 13/14	001
		DEC 96	

AA

10.5 SCHEMATIC

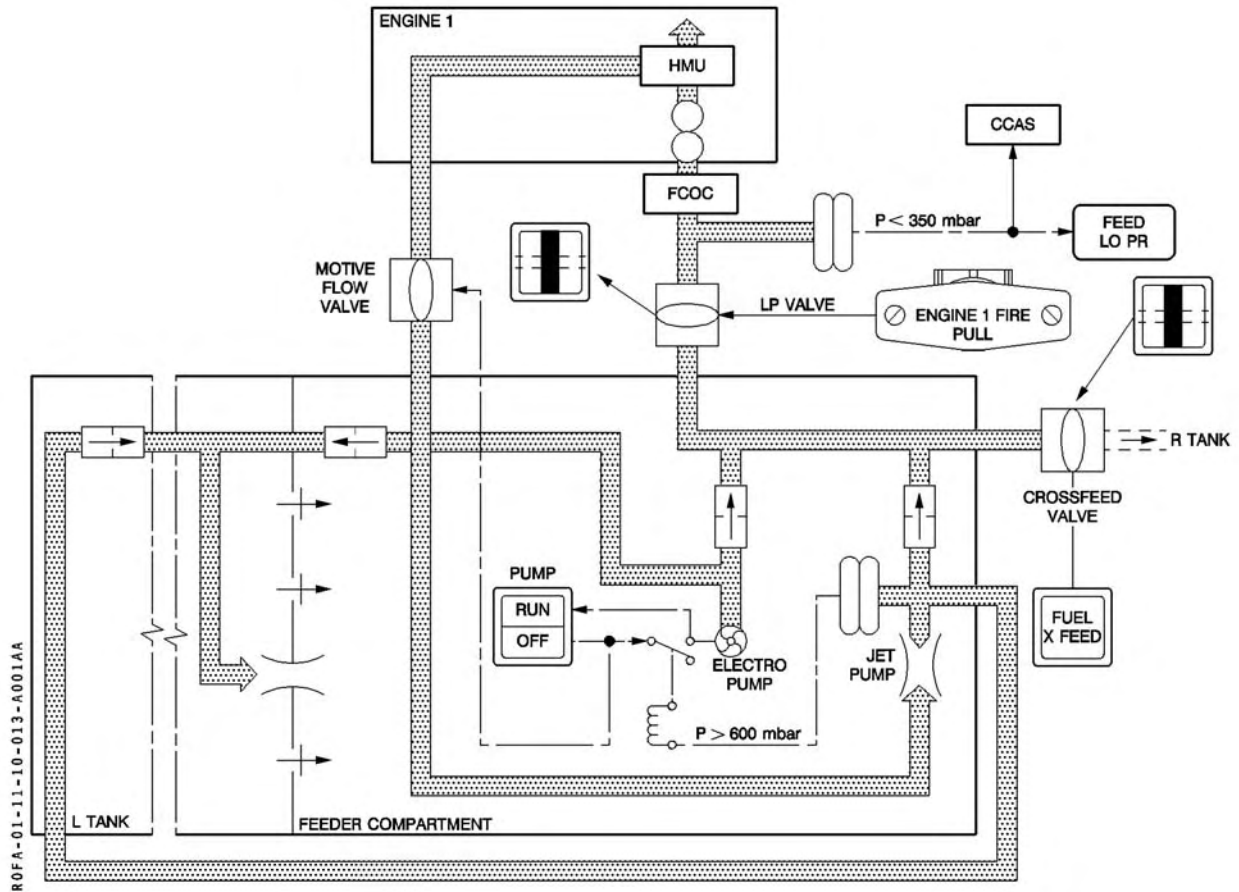

Eng.: PW124

ATTACHMENT F

Load and balance sheet for flights TUI 152F and TUI 1153,
old and new logbook.

TRIP FUEL (décollage)		1100	
---------------------------------	--	------	--

 الخطوط الدولية TUNINTER		(DEVIS DE POIDS ET FEUILLE DE CENTRAGE)	
OU	ADRESSE	ORIGIN	SIGN
	BRI	TUNIS	166
LDM	FLIGHT No/mas vol	DATE	A/C REG/immatriculation
	UG152F/06	06/10/06	TS/BP
		VERSION 70 Pax 30° & 29°	CREW/équipage
			2/2

BASIC WEIGHT (masse de base)	MAXIMUM WEIGHT (masse max)	ZERO FUEL WEIGHT (sans carburant)	TAKE OFF WEIGHT (décollage)	LANDING WEIGHT (atterrissage)
11330		11320	13720	11150
CORRECTIONS	TAKE OFF FUEL (carburant au décollage)		TRIP FUEL (décollage)	
		23470	21500	22150
DRY OPERATING WEIGHT (masse de base corrigée)	MAXIMUM ALLOWED TOW (limitation utile)			
11330				
TAKE OFF FUEL (carburant au décollage)	OPERATING WEIGHT (masse en opération)			
3770				
OPERATING WEIGHT (masse en opération)	ALLOWED TRAFFIC LOAD (charge autorisée)			
11700				

TAKE OFF FUEL (carburant au décollage)		3770	
--	--	------	--

Load sheet flight UG 152F (TUI 152F, ferry flight Tunis-Bari) - particular

“TAKE OFF FUEL” is the Block Fuel of 3800 kg – 30 kg (fuel for taxiing), which is equal to 3770 kg.

“TRIP FUEL” is equal to 1100 kg (fuel foresee for the Tunis-Bari leg).

K E W	.ER	CAPT STAFF NBR & SIGN	PERFORMANCE RECORD		LOG NBR
			ALL AIRCRAFT		Nº 075635
		A/C TYPE	A/C REG	D D M M Y Y	
		ATR72	TSWBB	DATE 050805	

LEG	FLT NBR	DEP	ARR	OUT UTC	OFF UTC	ON UTC	IN UTC
1	172	TUN	CTA	0705	0710	0805	0810
2	143	CTA	TUN	0915	0920	1035	1040
3	140	TUN	CTA	1115	1120	1220	1225
4	144	CTA	TUN	1355	1400	1510	1515
5							
6							

AIR WORTHINESS RELEASE IDENT. AND SIGN.						ENG. OIL QTY. READ ADD				A P U	
						#1	#2	#3	#4		
						REMAINING F	ADDED FUEL				
TOTAL FUEL	FUEL USED 1	FUEL USED 2	FUEL USED 3	FUEL USED 4	TOTAL USED	770	1560				
1	2290	321	330		650	1630					
2	1630	410	420		830	770	1600				
3	2260	322	338		660	1670					
4	1670	404	440		821	790	2b 2b				
5											
6											

UTC	S.A.T.	MACH.	I.A.S.	ALT.	T.A.T.	GROSS WEIGHT	AIR CON
1							
2							
3							
4							

POS	F.P.R.	N1	E.G.T.	N2	FUEL FLOW	ENGL BLD.	T.I.R. POS	OIL TEMP	OIL PRESS.	C VIB	T
	.001	.1%	1.°	.1%	50#		0.5	1°	1#	.1	1

RECORD TO THE NEAREST

IF THE PURPOSE OF THE FLIGHT IS A LOCAL TRAINING: OA = _____ NO = _____ (SEE LAND)

FLT NBR	STA	A/C TYPE	A/C REG	D	D	M	M	Y	Y	SEQ	S/N OFF	P/N OFF						
	CTA	ATR7	TSABA	0	5	0	8	0	5									
SUBJECT: No 068297 1										ACTION TAKEN:								
COMPLAINTS: Maintenance										VT Ref. fuel								
CREW IDENT										FAILING								
ATA NBR										N°OE	LAST SEQ							
FIRM CODE																		
										OIL REFILLING US QUARTS	AIRWORTHINESS RELEASE							
										#1	#2	#3	#4	APU	STA IDENT	SIGN		
										TIME UTC			D	D	M	M	Y	Y
													0	5	0	8	0	5

FLT NBR	STA	A/C TYPE	A/C REG	D	D	M	M	Y	Y	SEQ	S/N OFF	P/N OFF						
	DUN	ATR7	TSABA	0	5	0	8	0	5									
SUBJECT: No 068297 12										ACTION TAKEN:								
COMPLAINTS:										VT Ref. fuel								
CREW IDENT										FAILING								
ATA NBR										N°OE	LAST SEQ							
FIRM CODE																		
										OIL REFILLING US QUARTS	AIRWORTHINESS RELEASE							
										#1	#2	#3	#4	APU	STA IDENT	SIGN		
										TIME UTC			D	D	M	M	Y	Y
													0	5	0	8	0	5

FLT NBR	STA	A/C TYPE	A/C REG	D	D	M	M	Y	Y	SEQ	S/N OFF	P/N OFF						
	CTA	ATR7	TSABA	0	5	0	8	0	5									
SUBJECT: No 068297 3										ACTION TAKEN:								
COMPLAINTS: Maint.										VT Ref. fuel								
CREW IDENT										FAILING								
ATA NBR										N°OE	LAST SEQ							
FIRM CODE																		
										OIL REFILLING US QUARTS	AIRWORTHINESS RELEASE							
										#1	#2	#3	#4	APU	STA IDENT	SIGN		
										TIME UTC			D	D	M	M	Y	Y

FLT NBR	STA	A/C TYPE	A/C REG	D	D	M	M	Y	Y	SEQ	S/N OFF	P/N OFF						
114	CTA	ATR7	TSABA	0	5	0	8	0	5		179	748681-2						
SUBJECT: INSTRUMENT No 068297 4										ACTION TAKEN:								
COMPLAINTS: FUEL QTY INDICATOR R TK										Replace fuel qty indicator								
CREW IDENT										FAILING								
ATA NBR										N°OE	LAST SEQ							
FIRM CODE																		
										OIL REFILLING US QUARTS	AIRWORTHINESS RELEASE							
										#1	#2	#3	#4	APU	STA IDENT	SIGN		
										TIME UTC			D	D	M	M	Y	Y
													0	5	0	8	0	5



AIRCRAFT TECHNICAL REPORT

Complete in block capitals & press: **mm/yyyyddmm**

FLIGHT N°		RECH.		Sector		No of Landings	
1		2		3		7	
AVC Type		8		EVS Out		EVS In	
DEFECT SYMPTOM (if none, enter NIL)		ACTION TAKEN		ITEM CERTIFICATION		Authorisation	
Item Nr	0	Item Nr	14	Item Nr	17	Item Nr	18
DEFECT	10	A.D. Drained Nr	15	Limitation (A,B,C,D)	16	Limitation (A,B,C,D)	19
DEFECT CODE		A.D.D clear Nr	18		19		20
DEFECT			20		21		22
DEFECT CODE			23		24		25
DEFECT			26		27		28
DEFECT CODE			29		30		31
DEFECT			32		33		34
DEFECT CODE			35		36		37
DEFECT			38		39		40
DEFECT CODE			41		42		43
DEFECT			44		45		46
DEFECT CODE			47		48		49
DEFECT			50		51		52
DEFECT CODE			53		54		55
DEFECT			56		57		58
DEFECT CODE			59		60		61
DEFECT			62		63		64
DEFECT CODE			65		66		67
DEFECT			68		69		70
DEFECT CODE			71		72		73
DEFECT			74		75		76
DEFECT CODE			77		78		79
DEFECT			80		81		82
DEFECT CODE			83		84		85
DEFECT			86		87		88
DEFECT CODE			89		90		91
DEFECT			92		93		94
DEFECT CODE			95		96		97
DEFECT			98		99		100
DEFECT CODE			101		102		103
DEFECT			104		105		106
DEFECT CODE			107		108		109
DEFECT			110		111		112
DEFECT CODE			113		114		115
DEFECT			116		117		118
DEFECT CODE			119		120		121
DEFECT			122		123		124
DEFECT CODE			125		126		127
DEFECT			128		129		130
DEFECT CODE			131		132		133
DEFECT			134		135		136
DEFECT CODE			137		138		139
DEFECT			140		141		142
DEFECT CODE			143		144		145
DEFECT			146		147		148
DEFECT CODE			149		150		151
DEFECT			152		153		154
DEFECT CODE			155		156		157
DEFECT			158		159		160
DEFECT CODE			161		162		163
DEFECT			164		165		166
DEFECT CODE			167		168		169
DEFECT			170		171		172
DEFECT CODE			173		174		175
DEFECT			176		177		178
DEFECT CODE			179		180		181
DEFECT			182		183		184
DEFECT CODE			185		186		187
DEFECT			188		189		190
DEFECT CODE			191		192		193
DEFECT			194		195		196
DEFECT CODE			197		198		199
DEFECT			200		201		202
DEFECT CODE			203		204		205
DEFECT			206		207		208
DEFECT CODE			209		210		211
DEFECT			212		213		214
DEFECT CODE			215		216		217
DEFECT			218		219		220
DEFECT CODE			221		222		223
DEFECT			224		225		226
DEFECT CODE			227		228		229
DEFECT			230		231		232
DEFECT CODE			233		234		235
DEFECT			236		237		238
DEFECT CODE			239		240		241
DEFECT			242		243		244
DEFECT CODE			245		246		247
DEFECT			248		249		250
DEFECT CODE			251		252		253
DEFECT			254		255		256
DEFECT CODE			257		258		259
DEFECT			260		261		262
DEFECT CODE			263		264		265
DEFECT			266		267		268
DEFECT CODE			269		270		271
DEFECT			272		273		274
DEFECT CODE			275		276		277
DEFECT			278		279		280
DEFECT CODE			281		282		283
DEFECT			284		285		286
DEFECT CODE			287		288		289
DEFECT			290		291		292
DEFECT CODE			293		294		295
DEFECT			296		297		298
DEFECT CODE			299		300		301
DEFECT			302		303		304
DEFECT CODE			305		306		307
DEFECT			308		309		310
DEFECT CODE			311		312		313
DEFECT			314		315		316
DEFECT CODE			317		318		319
DEFECT			320		321		322
DEFECT CODE			323		324		325
DEFECT			326		327		328
DEFECT CODE			329		330		331
DEFECT			332		333		334
DEFECT CODE			335		336		337
DEFECT			338		339		340
DEFECT CODE			341		342		343
DEFECT			344		345		346
DEFECT CODE			347		348		349
DEFECT			350		351		352
DEFECT CODE			353		354		355
DEFECT			356		357		358
DEFECT CODE			359		360		361
DEFECT			362		363		364
DEFECT CODE			365		366		367
DEFECT			368		369		370
DEFECT CODE			371		372		373
DEFECT			374		375		376
DEFECT CODE			377		378		379
DEFECT			380		381		382
DEFECT CODE			383		384		385
DEFECT			386		387		388
DEFECT CODE			389		390		391
DEFECT			392		393		394
DEFECT CODE			395		396		397
DEFECT			398		399		400
DEFECT CODE			401		402		403
DEFECT			404		405		406
DEFECT CODE			407		408		409
DEFECT			410		411		412
DEFECT CODE			413		414		415
DEFECT			416		417		418
DEFECT CODE			419		420		421
DEFECT			422		423		424
DEFECT CODE			425		426		427
DEFECT			428		429		430
DEFECT CODE			431		432		433
DEFECT			434		435		436
DEFECT CODE			437		438		439
DEFECT			440		441		442
DEFECT CODE			443		444		445
DEFECT			446		447		448
DEFECT CODE			449		450		451
DEFECT			452		453		454
DEFECT CODE			455		456		457
DEFECT			458		459		460
DEFECT CODE			461		462		463
DEFECT			464		465		466
DEFECT CODE			467		468		469
DEFECT			470		471		472
DEFECT CODE			473		474		475
DEFECT			476		477		478
DEFECT CODE			479		480		481
DEFECT			482		483		484
DEFECT CODE			485		486		487
DEFECT			488		489		490
DEFECT CODE			491		492		493
DEFECT			494		495		496
DEFECT CODE			497		498		499
DEFECT			500		501		502
DEFECT CODE			503		504		505
DEFECT			506		507		508
DEFECT CODE			509		510		511
DEFECT			512		513		514
DEFECT CODE			515		516		517
DEFECT			518		519		520
DEFECT CODE			521		522		523
DEFECT			524		525		526
DEFECT CODE			527		528		529
DEFECT			530		531		532
DEFECT CODE			533		534		535
DEFECT			536		537		538
DEFECT CODE			539		540		541
DEFECT			542		543		544
DEFECT CODE			545		546		547
DEFECT			548		549		550
DEFECT CODE			551		552		553
DEFECT			554		555		556
DEFECT CODE			557		558		559
DEFECT			560		561		562
DEFECT CODE			563		564		565
DEFECT			566		567		568
DEFECT CODE			569		570		571
DEFECT			572		573		574
DEFECT CODE			575		576		577
DEFECT			578		579		580
DEFECT CODE			581		582		583
DEFECT			584		585		586

ATTACHMENT G

Document of interest concerning search and rescue phases

INCIDENTE AEREO TUNINTER DEL 06/08/05

ORA	EVENTO
15:45	Decollo dall'ospedale Cervello per Lampedusa
16:00	Monreale 4500 ft. Richiesta di Palermo APP di procedere per il luogo dell'ammarraggio al largo di Capo Gallo. Successivamente comunicato 010PRS12.
16:06	Arrivo sul punto 010PRS12. Aereo AirOne comunica di essere sul punto dell'ammarraggio e di avere in vista il relitto. L'aereo AirOne comunica la posizione 053PRS22.
16:10	Arrivo sul relitto in coordinate 38°23'35.6"N 013°27'01"E
16:20	Arrivo di ulteriori elicotteri in zona. Inizio orbitamento in senso antiorario di noi più altri 2 elicotteri. Comunicazione all'aria agli elicotteri presenti di seguire una circuitazione antioraria
16:25	Arrivo della prima motovedetta Guardia Costiera che si avvicina al relitto e recupera le persone sull'ala del velivolo a mare.
16:29	Arrivo della seconda motovedetta Guardia Costiera che si posiziona a N del relitto e inizia il recupero delle persone a mare
16:30 ca	Dichiarazione a Palermo APP e all'aria di on-scene-commander (OSC). Istruiti eli Polizia e eli VV.FF. di circuitare mantenendo la separazione e all'eli dei Carabinieri di mantenere 500 ft GND
16:33	Arrivo della terza motovedetta che si affianca alla precedente a N del relitto
16:36	A seguito di avvistamento di una persona in galleggiamento, cosciente e senza giubbotto di salvataggio, rilascio di un nostro salvagente. Caduto a circa tre metri dal superstite. Avvistato il superstite che recuperava il salvagente, lo gonfiava e lo mette sotto le gambe
16:38	Arrivo del gommone della Polizia che recupera 4 persone inanimate a E del relitto
16:44	Palermo APP chiede a noi, in qualità di OSC se le ambulanze devono rimanere presso l'aeroporto di Punta Raisi o devono andare al porto. Richiesto a Palermo APP di mandare le ambulanze al porto perché zona più vicina al relitto
16:46	La prima motovedetta della Guardia Costiera si dirige verso il Porto di Palermo
16:49	La seconda motovedetta si dirige verso il porto di Palermo
6:52	Avvistata donna inanimata in galleggiamento a NNW dal relitto
16:55	La terza motovedetta si dirige verso il porto di Palermo
16:56	Elicotteri presenti in zona: I-BRMA, Poli 34, Volpe 141, Drago 21, I-Rescue 1, Fiamma 20, I-CGCL.
17:01	Arrivo del Drago 21 che rilascia 5 sommozzatori vicino al relitto. Prima del rilascio istruiti gli elicotteri di spostarsi tutti a N del relitto per lasciare libera la zona al Drago 21
17:04	Drago 21 completa il rilascio dei sommozzatori e rientra a Palermo.
17:05	Istruiti gli elicotteri ad effettuare una ricerca settoriale dando i seguenti settori: I-BRMA settore sud, Poli 34 Settore nord, I-CGCL settore est, Fiamma 20 a ovest, Volpe 141 orbitamento sulla zona a 500 ft, I-Rescue 1 rimanere fuori la zona di ricerca per un eventuale utilizzo come mezzo per il recupero naufraghi. Confermato dall'I-Rescue 1 di essere abilitato al solo recupero persone animate.
17:08	Avvistato gommone dirigersi verso il porto di Palermo con 4 persone inanimate a bordo
17:09	Poli 34 lascia la zona di operazioni, seguendo il proprio gommone, senza avvisare l'OSC
17:13	Il Poli 34 conferma di aver lasciato la zona di operazioni
17:14	Riassegnato il settore nord al Volpe 141 e istruito l'I-Rescue 1 ad orbitare in zona a 500 ft. Ricevuta indicazione da Palermo APP che le persone a bordo erano 39, compreso

	l'equipaggio. La Centrale Operativa 118 riporta che al momento risultavano 20 persone superstiti e 7 morti.
17:15	L'I-CGCL viene chiamato dalla Centrale Operativa 118 e lascia la zona.
17:19	Avvistata una motonave proveniente dal settore nord che punta sul porto di Palermo con rotta che passa sul luogo dell'ammarraggio. Date indicazioni all'I-Rescue 1 di contattarli con il VHF marino e fargli presente della emergenza in atto. Eventualmente di chiedere il supporto della motonave, rallentando a lento moto e partecipando alla ricerca o, nel caso contrario, di passare al largo della zona. Il Volpe 141 riporta che la motonave è il "Raffaele Rubattino". Dato indicazioni al I-Rescue 1 di avvicinarsi alla motonave e farla deviare
17:21	L'I-Rescue 1 riporta di non riuscire a mettersi in contatto con la motonave ma che questa ha accostato a destra per passare al largo della zona dell'ammarraggio
17:26	Riportate le coordinate aggiornate del relitto a Palermo APP: 38°22'51"N 013°28'08"E
17:31	Riassegnati i settori di ricerca: Fiamma 20 sul relitto per un raggio di 1 NM, I-Rescue 1 settori nord e est, Volpe 141 settore ovest, I-BRMA settore sud
17:43	I-Rescue 1 riporta di avere avvistato 3 persone inanimate, successivamente recuperate da una motovedetta.
18:00	La Centrale Operativa 118 ci chiede di lasciare la zona di operazioni per un intervento primario a Villagrazia di Carini.
18:01	L'I-BRMA lascia la zona delle operazioni di soccorso e trasferisce le competenze dell'OSC all'I-Rescue 1 che conferma il trasferimento dell'incarico.
18:25	Atterraggio a Villagrazia di Carini presso il campo sportivo
19:00	Decollo con il paziente
19:10	Atterraggio a Bocca di Falco per rilascio del paziente all'ambulanza già presente in aeroporto
19:30	Decollo da Bocca di Falco
19:40	Atterraggio all'ospedale Cervello

ATTACHMENT H

Sequence of relevant events, relevant parameters diagrams
deduced from the FDR data

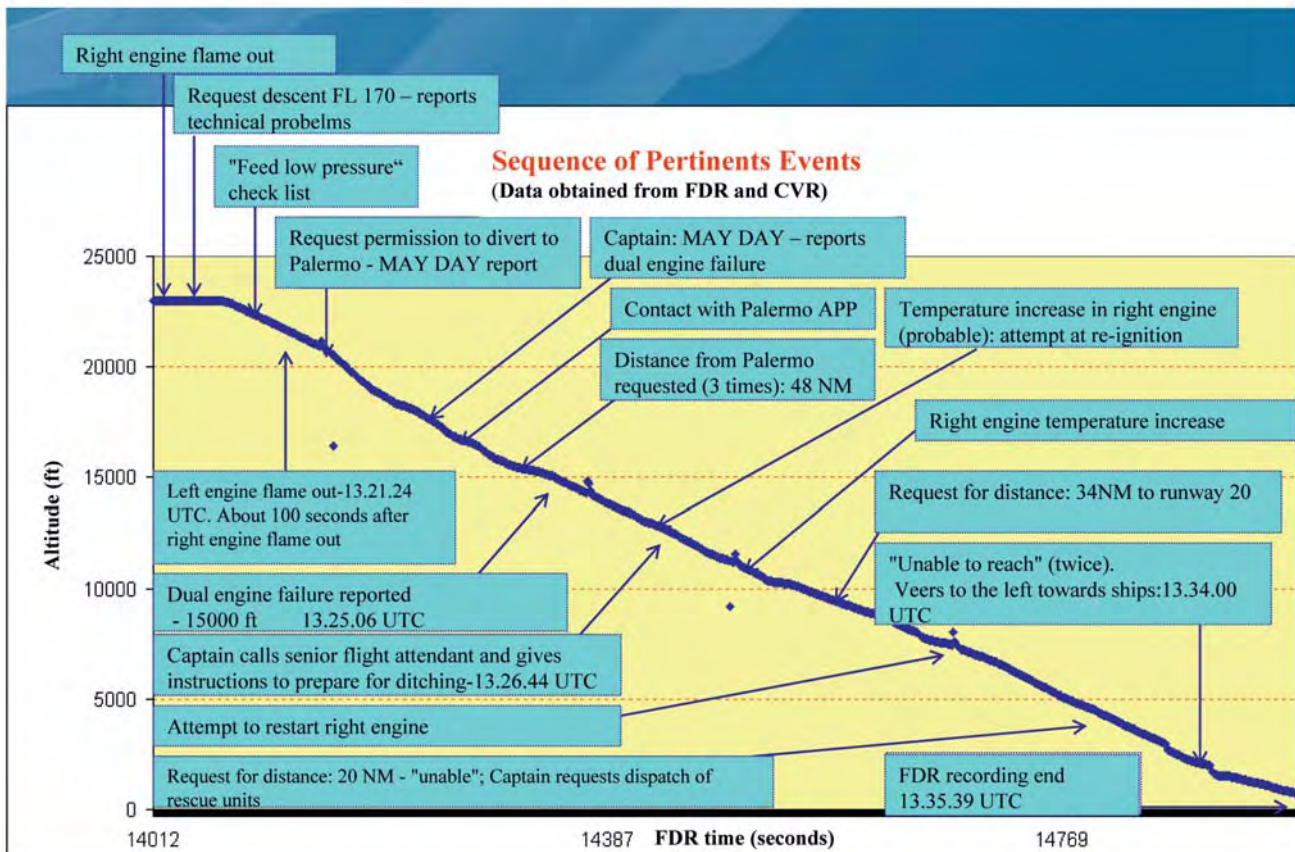

ATR 72 / TS-LBB Ditching - 6 august 2005
Flight TUI 1153 - Sequence Events of interest

N.	Event	FDR Time (seconds)	UTC time (hh.mm.ss from FDR)	Altitude (ft)	Airspeed (kts)	Note	Distance from Palermo TVOR/DME
1	Right engine shut down	14030	13.19.43	22.940	182	Radio contact with Roma control (Roma ACC)	
2	Request descent to FL 170	14058	13.20.10	22.940	166	TUI 1153 declares technical problems	
3	"Feed low pressure" check list reading	14091	13.20.44	22.410	165		
4	Left engine shut down	14131	13.21.24	21.340	178	100 seconds since right engine shut-down	
5	Request diversion to Palermo	14142	13.21.35	21.060	175		
6	MAYDAY	14159	13.21.51	20.550	171		
7	MAYDAY again	14220	13.22.53	18.140	178	Captain: "We lose both engines" - 14230	
8	Radio contact with Palermo approach (APP)	14255	13.23.28	16.960	177		
9	TUI 1153 confirms MAYDAY conditions	14281	13.23.54	16.290	168	Request latest wind conditions in Palermo	

ATR 72 / TS-LBB Ditching - 6 august 2005
Flight TUI 1153 - Sequence Events of interest

N.	Event	FDR Time (seconds)	UTC time (hh.mm.ss from FDR)	Altitude (ft)	Airspeed (kts)	Note	Distance from Palermo TVOR/DME
10	TUI 1153 requests distance from Palermo (3 times)	14295 - 14312	13.24.08 - 13.24.25	15780-15400	170-164	Palermo APP does not understand the distance request (DME) done by TUI 1153; then they will and it was communicated	48 NM
11	TUI 1153 acknowledge the distance (48 NM) and the Captain says in the cockpit: "impossible" (3 times)	14326	13.24.39	15.240	151		
12	TUI 1153 requests to Palermo APP if there is another airport closest than Palermo	14345	13.24.58	14.880	144	TUI 1153 informs Palermo APP that they have both engines failed and that they are at 15000 ft - 13.25.02 UTC	
13	TUI 1153 requests again whether there is closest airfield ("Any nearest airport where we can land")	14366	13.25.19	14.320	145	Palermo APP does not understand the request made by TUI 1153 regarding the closest airport	
14	Another aircraft contact Palermo repeating the same request on the closest airport made by TUI 1153	14393	13.25.46	13.610	147		
15	Palermo APP informs that the distance is 40NM	14418	13.26.11	12.940	149		40 NM
16	Right engine temperature rises above limit; probably a restart attempt	14431		12.710	144		
17	Captain tells to chief cabin attendant to prepare the cabin for a ditching	14450		12.160	148	Palermo APP does not know yet about the intention of TUI 1153 to perform a ditching	
18	Palermo APP: continue inbound and report field in sight; also to confirm if they land for runway 20 or 25	14485	13.27.18	11.240	149		
19	Right engine temperature rise; probably a restart attempt	14497		10.960	149		

ATR 72 / TS-LBB Ditching - 6 august 2005
Flight TUI 1153 - Sequence Events of interest

N.	Event	FDR Time (seconds)	UTC time (hh.mm.ss from FDR)	Altitude (ft)	Airspeed (kts)	Note	Distance from Palermo TVOR/DME
20	TUI 1153 requests distance from the airport: 37 NM	14523		10.240	155		37 NM
21	TUI 1153 requests once more if there is a closest airport	14542		10.070	140		
22	TUI 1153 request sdistance from the airport: 34 NM for runway 20	14576		9.350	140		34 NM
23	Captain repeats in cockpit that it is impossible (3 times)	14588		9.120	139		
24	TUI 1153 request to Palermo APP to be vectored for a straight-in runway 20 ("... we lost all instruments....")	14606		8.790	139		
25	Palermo APP: difficulties in understanding the request made by TUI 1153 regarding "vectoring", "heading": then says tha they are in position for a straight-in runway 20	14628		8.350	141		
26	Right engine restart attempt	14664		7.750	144		
27	Palermo APP request number of people on board and the fuel quantity	14675		7.410	137	TUI 1153: 35 passengers and "1800" as fuel quantity on board	
28	TUI 1153 requests distance: 27 NM	14732		6.060	134		27 NM
29	Copilot starts to perform the ditching check list	14777		4.840	136		
30	TUI 1153 requests distance: 20 NM	14800		4.310	130		20 NM

ATR 72 / TS-LBB Ditching - 6 august 2005
Flight TUI 1153 - Sequence Events of interest

N.	Event	FDR Time (seconds)	UTC time (hh.mm.ss from FDR)	Altitude (ft)	Airspeed (kts)	Note	Distance from Palermo TVOR/DME
31	TUI 1153 reports that they are not able to reach the runway and asks for the rescue service	14802	13.32.35	4.260	130		
32	TUI 1153: "Unable to reach" (2 times) and inform Palermo that he is going towards two "boats"	14887		2.040	134		
33	FDR ending	14988	13.35.39	728	125		
34	Sound ("cricket"). Most probably the stall warning sound	15035					
35	Impact with the sea - CVR ending	15045	13.36.36			Radial 053 from Palermo TVOR/DME	22 NM

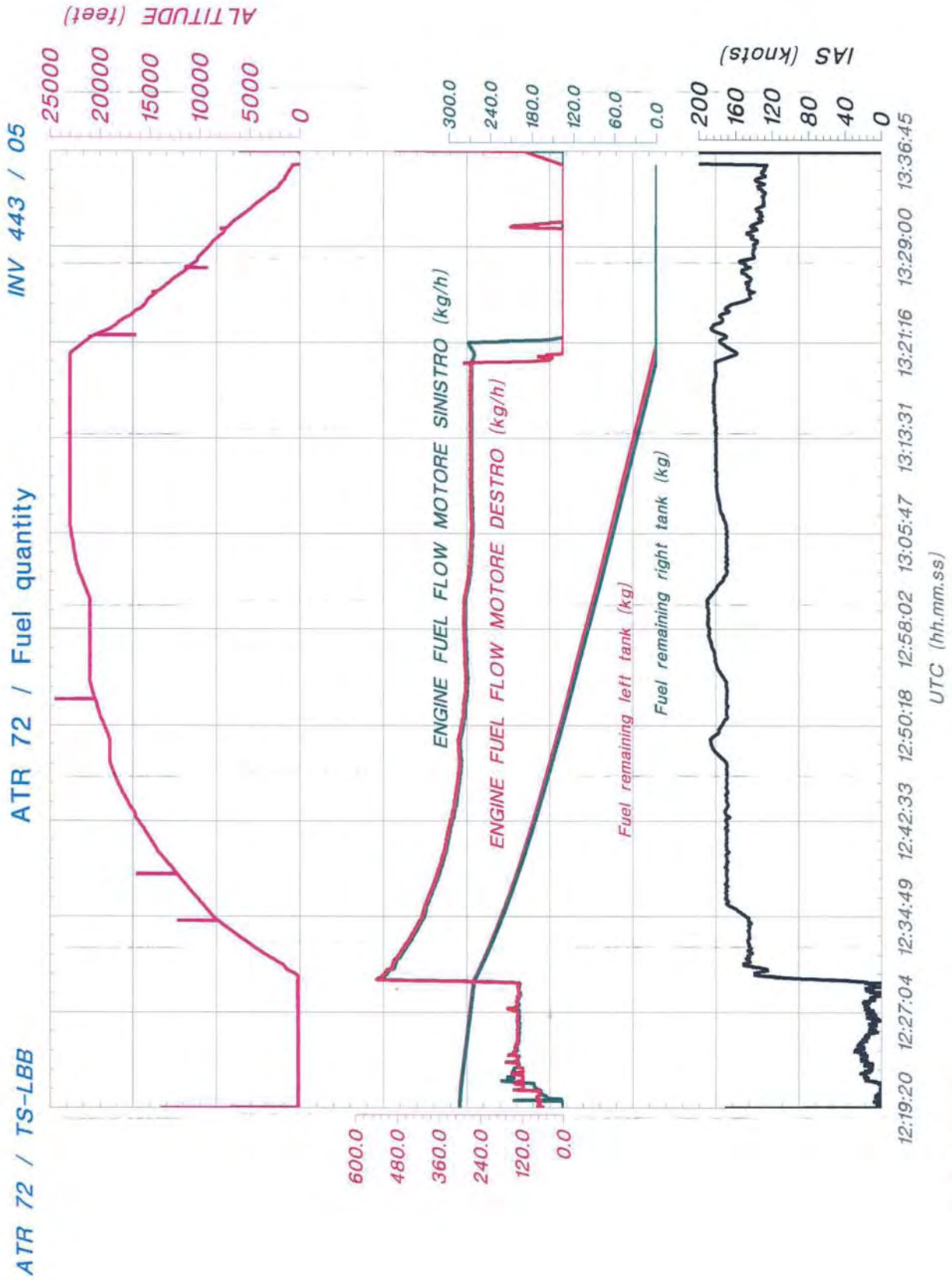

Dati definitivi

Created: November 02, 2007

ANSV Laboratorio

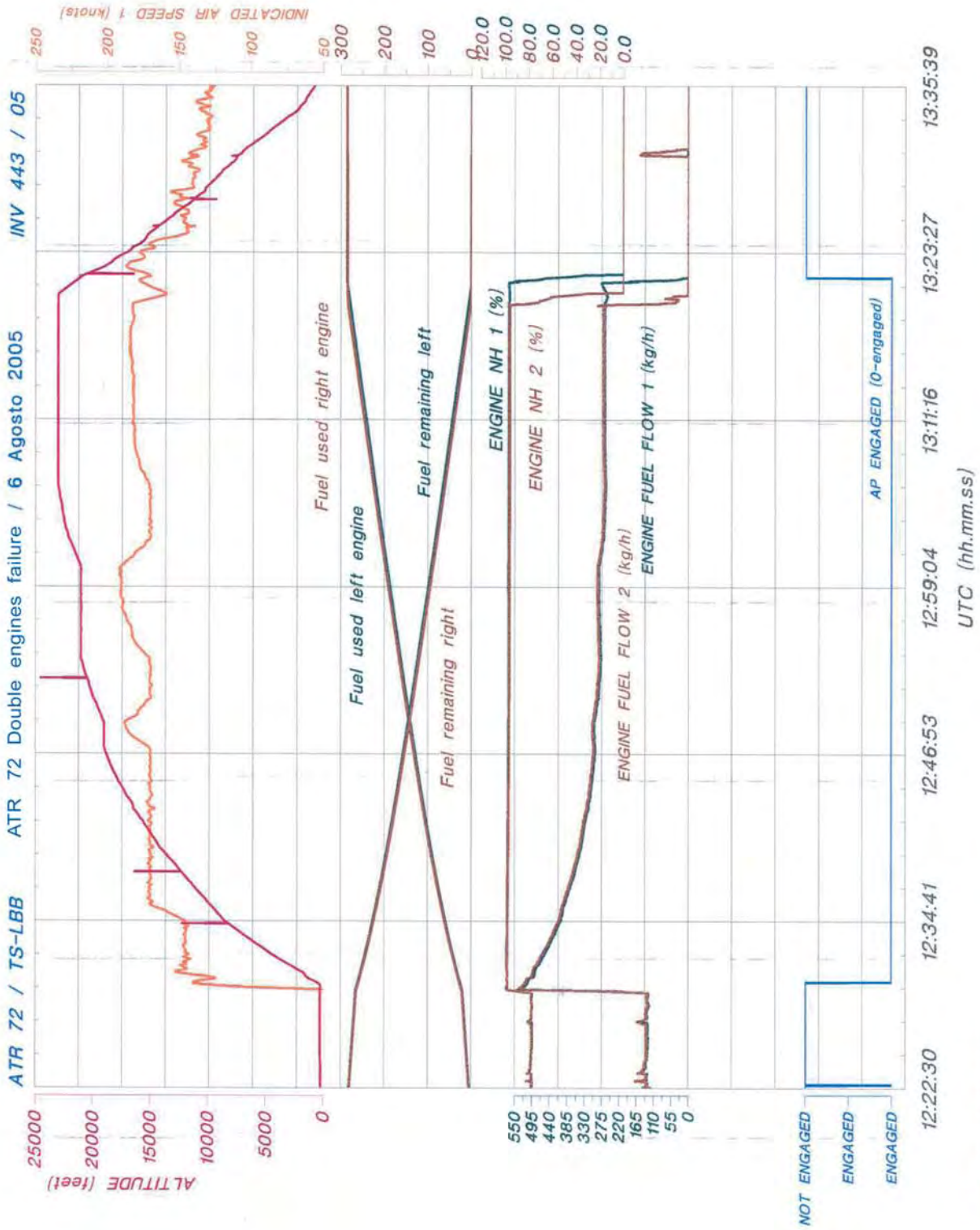

Dati definitivi
 Created: November 02, 2007
 ANSV Laboratorio

ATR 72/TS-LBB

Engines parameters - Flight TUI 1153 - take-off until initial cruise altitude

INV 443/05

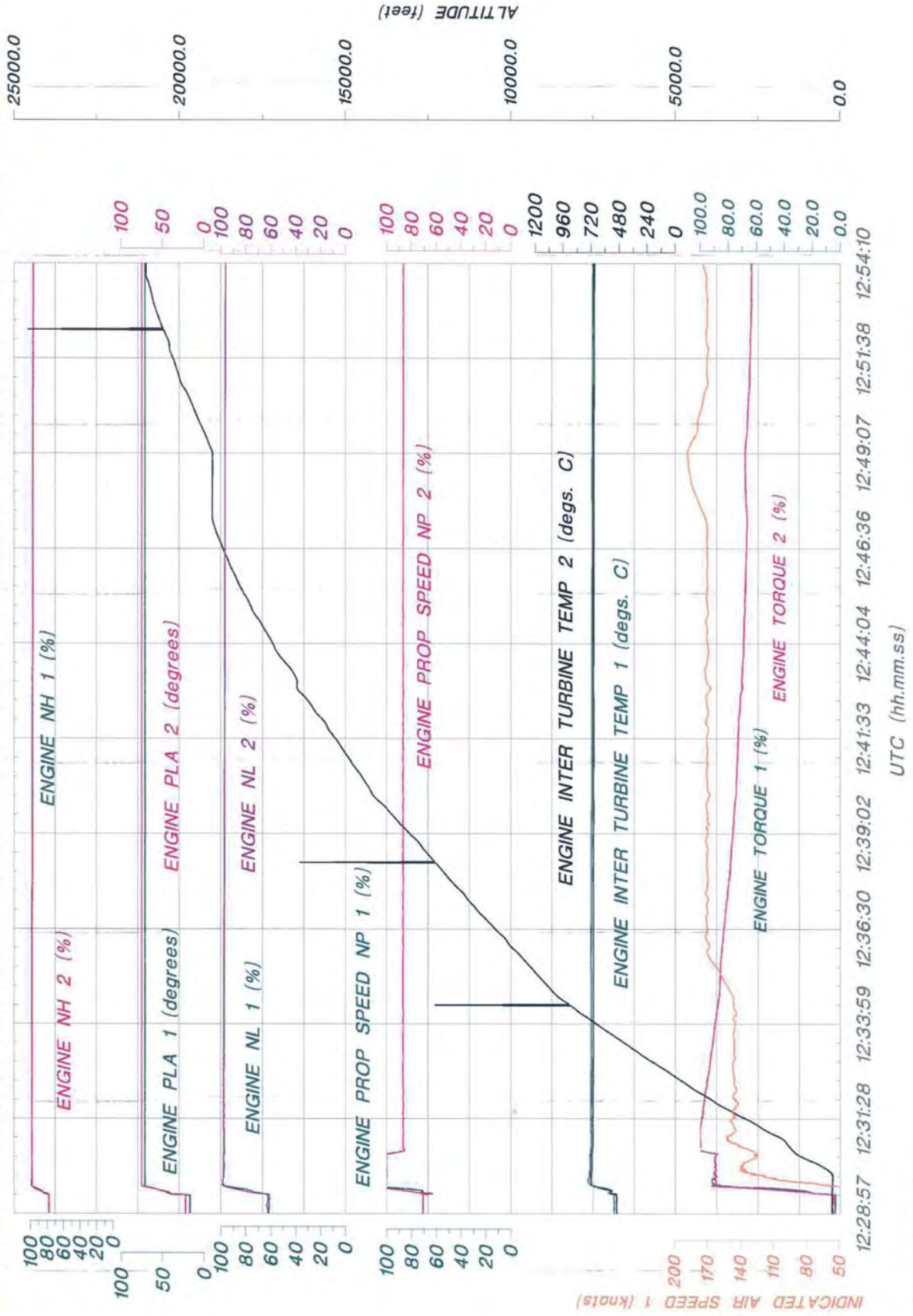

Dati definitivi

Created: November 02, 2007

ANSV Laboratorio

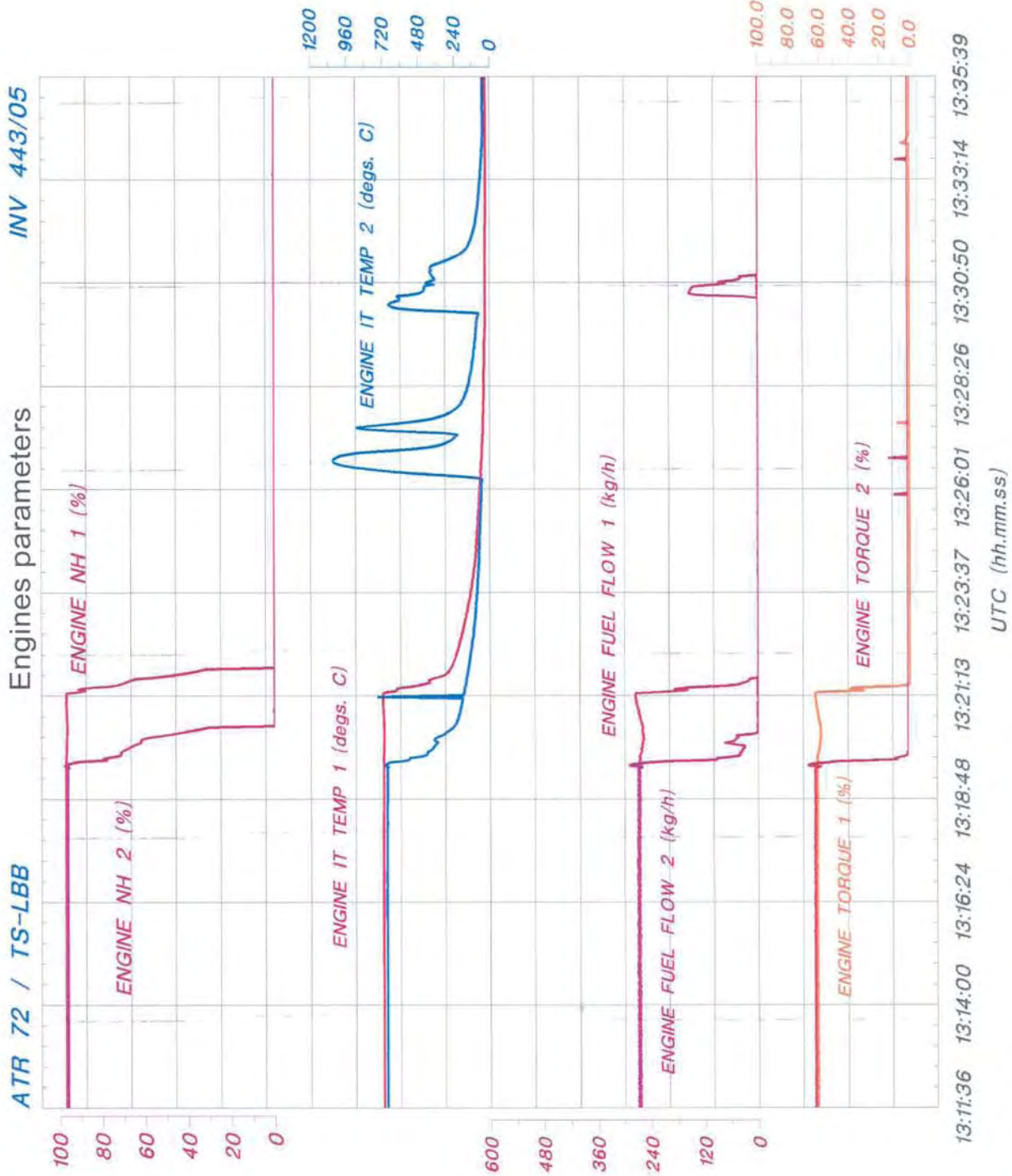

Dati definitivi
 Created: November 02, 2007

ANSV Laboratorio

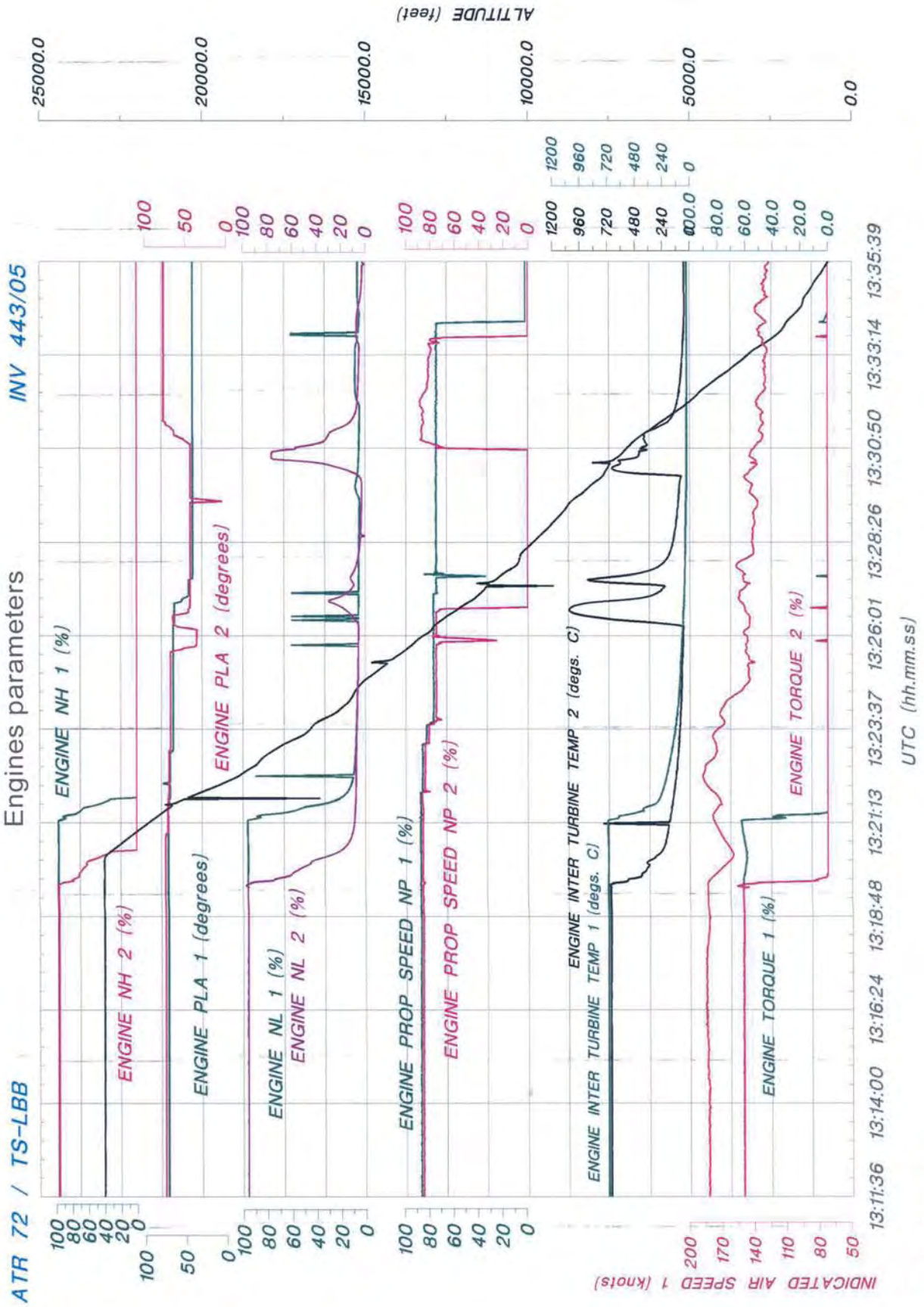

Dati definitivi
 Created: July 19, 2007

ANSV Laboratorio

ATR 72 / TS-LBB

Engines parameters - Flight TUI 1153 - engines shut - down

INV 443/05

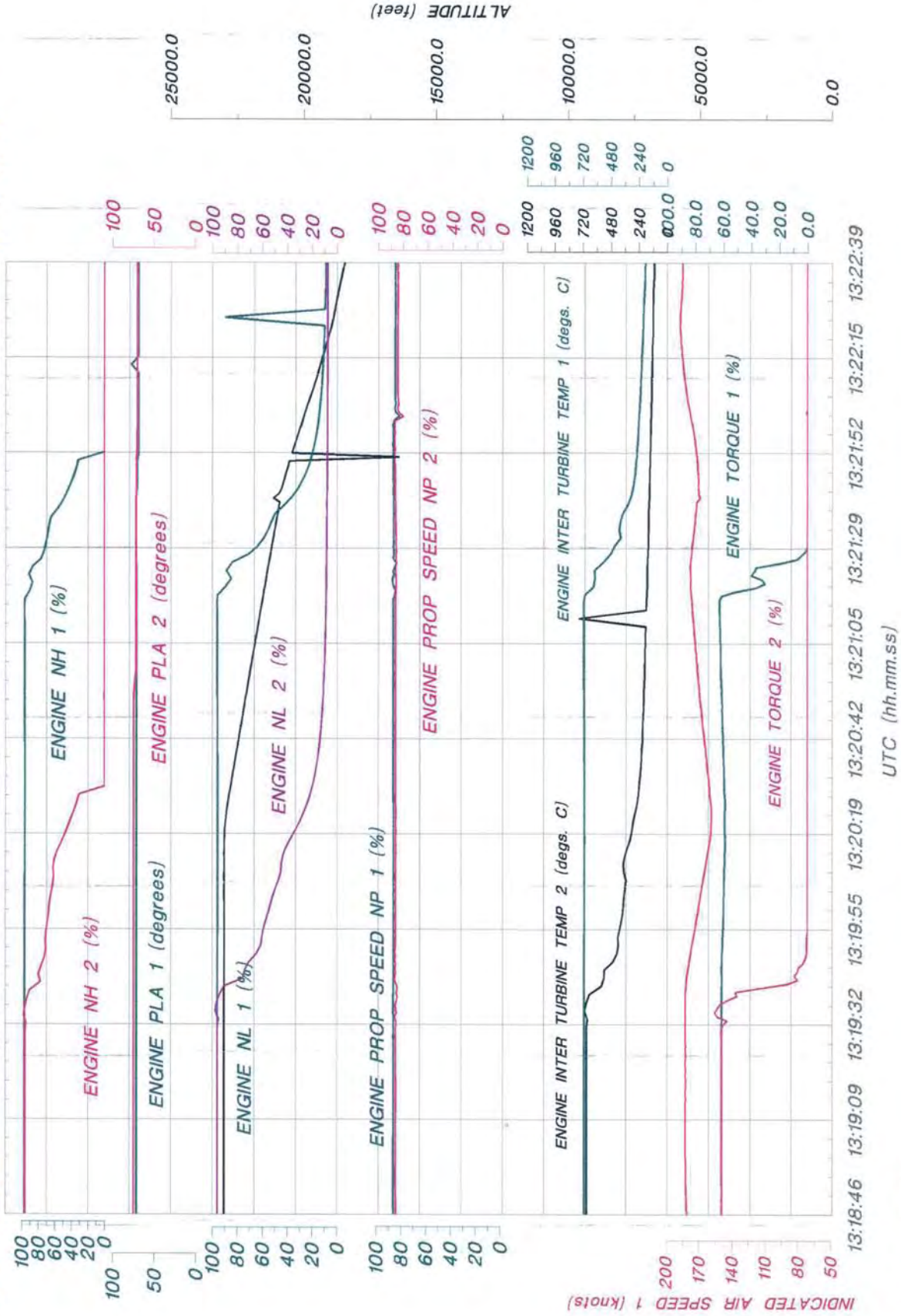

Dati definitivi

Created: November 02, 2007

ANSV Laboratorio

ATR 72 / TS-LBB Engines parameters - Flight TUI 1153 - engines shut - down INV 443/05

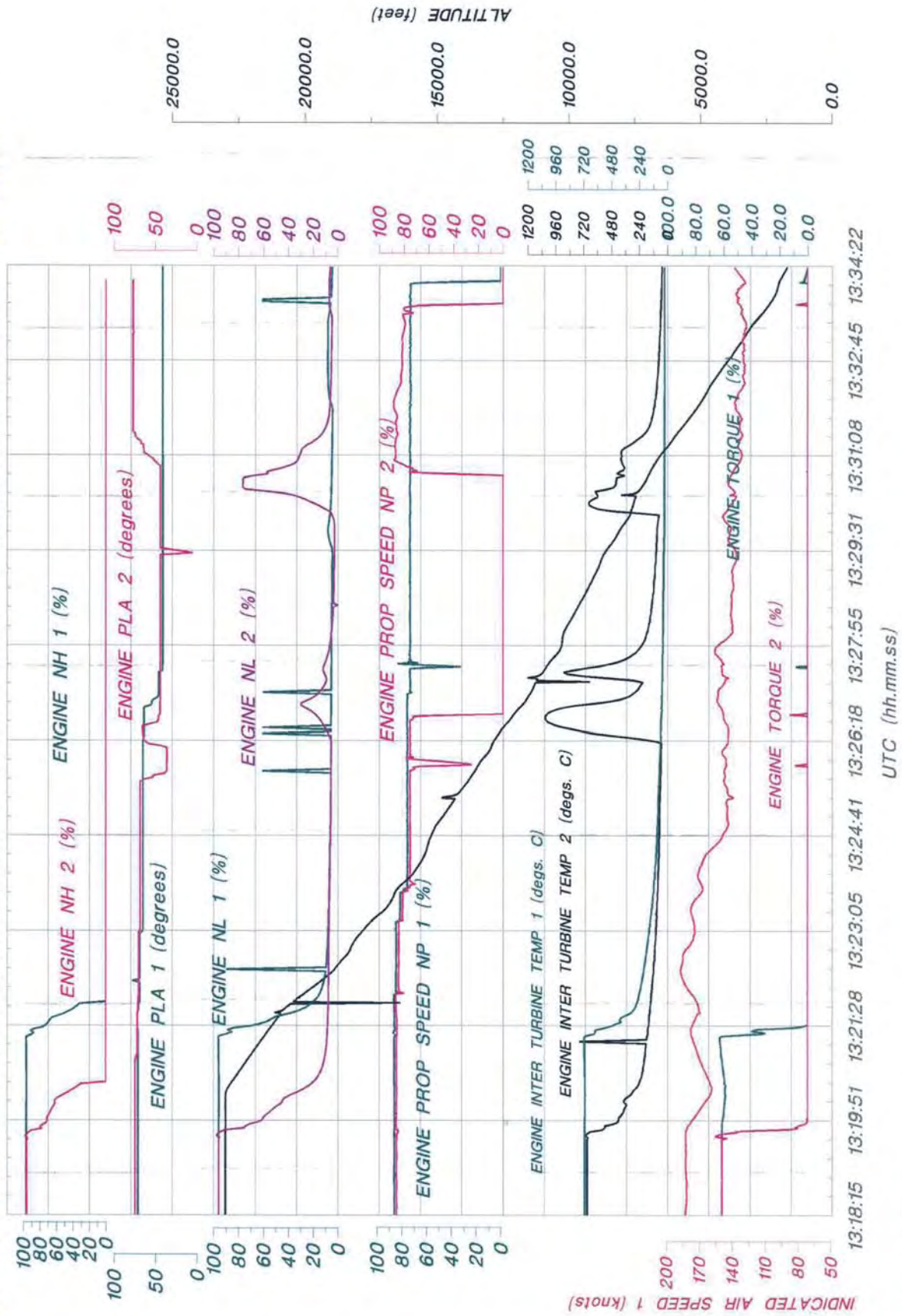

Dati definitivi
 Created: November 02, 2007
 ANSV Laboratorio

ATR 72/TS-LBB

Flight TUI 1153 - Aircraft attitude final part

INV 443/5

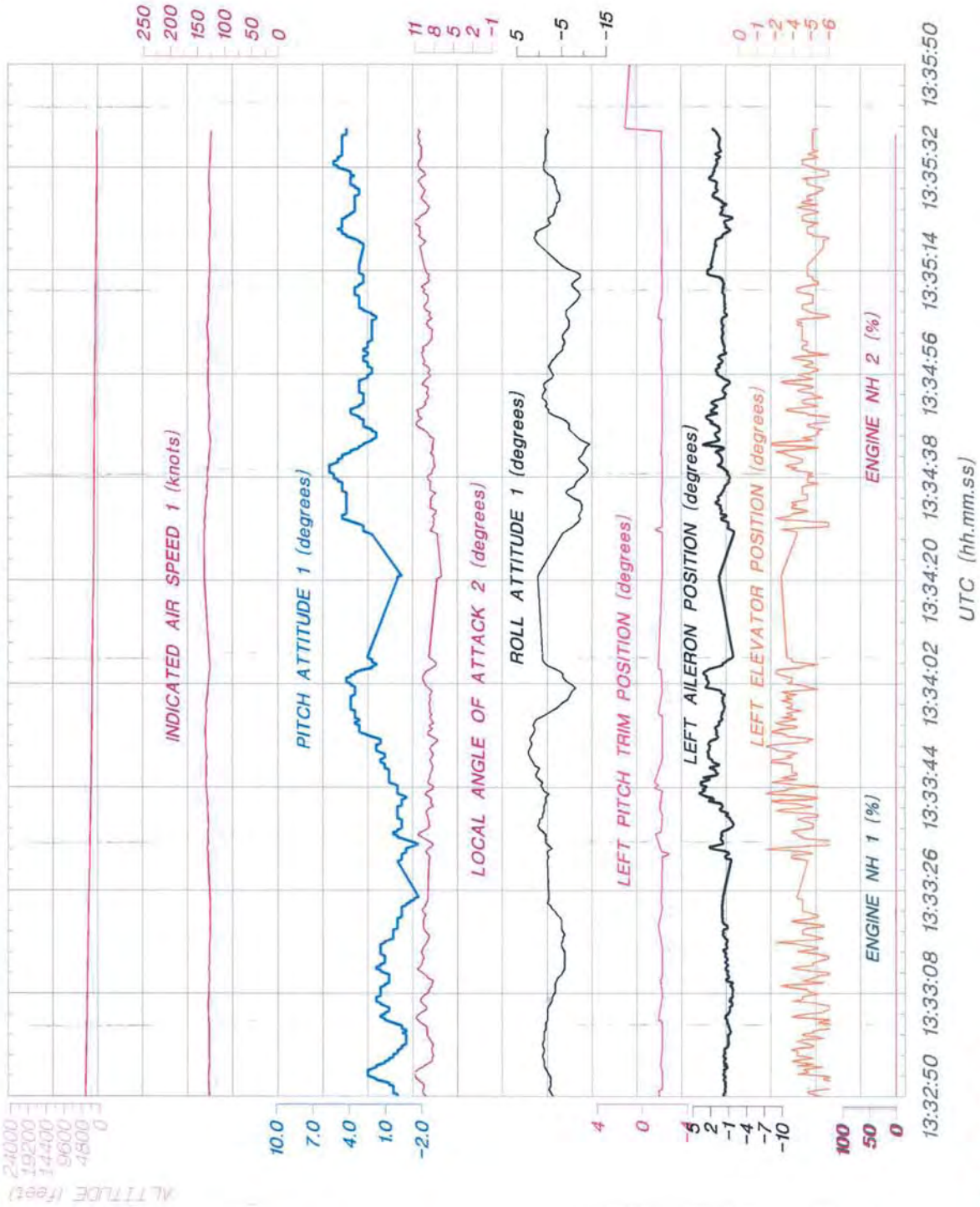

Dati definitivi
Created: November 02, 2007

ANSV Laboratorio

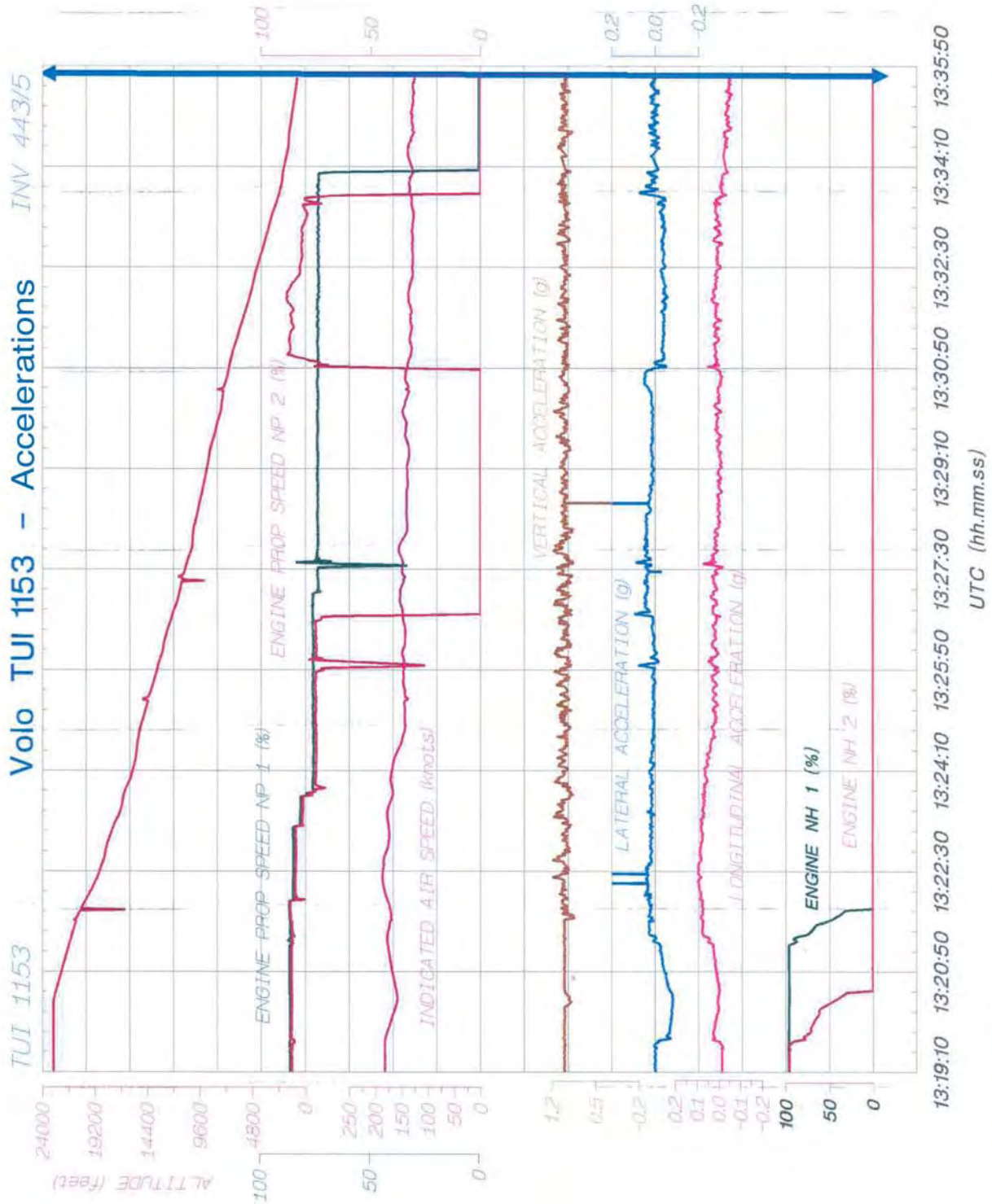

Dati definitivi
 Created: January 15, 2007

ANSV Laboratorio

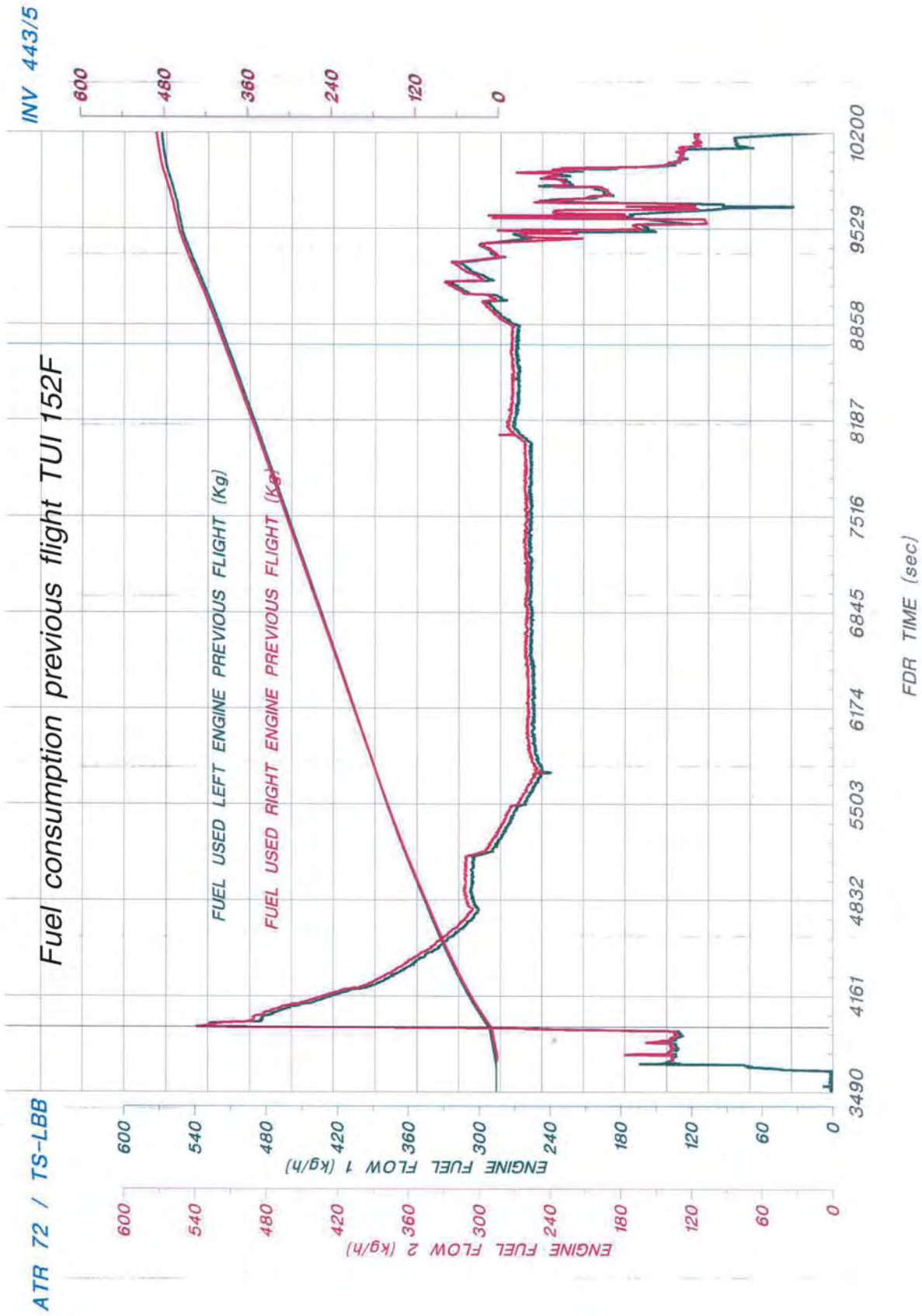

Dati finali
Created: October 13, 2005
ANSV Laboratorio

ATTACHMENT I

Animated reconstruction of Flight TUI 1153:
take-off from Bari and final phase of the flight
(contained in the attached CD-ROM)

ATTACHMENT L

ANSV remarks on State's accredited comments

ANSV remarks on comments from the accredited States

1. Preamble

First of all, ANSV would like to thank all the State's accredited representatives and their advisors for the invaluable support received during the investigation.

ANSV analyses were essentially driven with the only purpose of increasing flight safety in the interest of the entire aviation community and if some conclusions made in the report can be seen as biased or critical towards someone, this was not the intended purpose.

Some comments provided by the accredited states were not fully agreed by ANSV and hence reported in Appendix, as per Annex 13 ICAO provisions.

2. ANSV remarks on the rights to the accredited representatives

As soon as it had been notified about the accident, ANSV, as provided in Annex 13 ICAO (5.10 provision) and in legislative decree 66 of February 25th, 1999, arranged the requisite coordination with the appropriate judicial authority to ensure the proper, prompt recovery of all the material required to ascertain the causes of the occurrence. All the actions taken by ANSV in relation to the coordination with the Judicial Authority have been accounted in the report (paragraphs 1.18.1. and 2.12.).

In the report ANSV duly underlined the limits of the technical investigation, as also in other States whose criminal law procedures are those equivalent to that of Italy, in presence of the possible simultaneous judicial authority inquiry which, unlike the technical investigation, is carried out based on criminal procedure rules. Such limits have been precisely underlined also by ICAO during the audit to the Italian civil aviation system, carried out in May 2006.

ANSV within its field of responsibility, in completion of the technical investigation in question attempted to guarantee observance of those regulatory provisions contained in Annex 13 ICAO that recognize precise rights to certain States. Part of these rights, however, was found to be limited in the light of that envisaged by the criminal procedures system in force, on the occasion of the simultaneous inquiry by the judicial authority.

Considering the above, ANSV addressed specific safety recommendations to the Italian Minister of Justice and Minister of Transport in order to take necessary legislative initiatives aimed to ensure the rights of representatives and relevant consultants of foreign agencies appointed for technical investigations, according to provisions stated in Annex 13 ICAO, also in the event of a judicial authority inquiry.

3. Specific remarks on BEA and ATR technical comments

BEA, in addition to its comments, forwarded also the ATR technical comments (BEA technical advisor).

- *ANSV remarks on BEA technical comments*

JIC RAI issue

We fully agreed on the purpose of the JIC on removal and installation (RAI) of the Fuel Quantity Indicator; in the report it is never stated that the JIC RAI **must or should** have prescribed a congruity check between the indication and the effective fuel quantity on board using the dripsticks.

ANSV statements regarding the JIC RAI in the report are correct and they are based on the available evidences. They just states the fact that the JIC did not require a congruity check before the event. After that, the JIC was amended as further preventive measure from ATR. This consideration is not to be regarded too critical towards ATR.

An additional check, as amended in the new JIC in April 2006, cannot be considered as foolproof concept.

ANSV is in the opinion that an hardware modification on the FQI installation would be high desirable as real foolproof design. This was the concept that drove us to issue the safety recommendation to EASA (ANSV-7/443-05/2/A/05) which called for the possibility to mandate a modification of the Fuel Quantity Indicator installation in order to prevent any incorrect fitting. The main purpose was not to just recommend a change or amend the procedure of removal and installation, but to consider the possibility of an hardware modification. An hardware modification on the FQI installation would be high desirable as real foolproof design.

ANSV would like to draw the attention to all stakeholder in aviation that the setting up of allegedly flawless procedures are not always enough when safety is to be the first priority. Differences in the hardware and/or shape between similar components especially those directly related to safety are of paramount importance.

The fact that the Illustrated Part Catalog (IPC) is the only reference to check the applicability of different Part Numbers (PN) is stated in the report. The mechanics involved

in the event did not check prior to the removal and installation of the FQI the compatibility with the IPC and this was considered one of the active failure of the accident.

Revision of ATR recommended ditching procedure issue

Seen from a different perspective, the ditching is an emergency manoeuvre that can be performed with or without engine running, depending on the particular condition. Without engines running the ditching can be more difficult, especially in terms of obtaining the ATR recommended parameters for ditching, such as low vertical speed, pitch angle of 9° and low longitudinal speed. It is obvious that without thrust pilot workload is increased and a recommended procedure in this case would be advisable. For this reason ANSV is addressing to EASA a specific safety recommendation.

It has to be pointed out that the actual procedure in case of night ditching, shutting down both engines may be performed at captain discretion, immediately after the impact.

As reported in the justification sentence in the report, in case of failure of both engines, it is quite difficult for the flight crew to adapt to recommendations shown in the ditching emergency procedure. In absence of thrust, and without primary indications of aircraft instruments due to the subsequent power supply failure, it is, in fact, more difficult to coordinate all elements necessary to perform a good ditching manoeuvre (speed, vertical speed, attitude, direction, moment and point of contact with the sea).

ANSV is not recommending a new procedure, but is only recommending to amend the existing one in order to consider the ditching emergency procedure with and without both engines operating. We do not consider that the amendment of the ditching procedure could confuse crews and reduce their performance.

- *ANSV remarks on ATR comments*

ANSV prefers not to make any specific remarks on the ATR general statements and comments to the report.

ATR proposals for change were not included in the report and reasons for that were given directly to ATR during specific meetings.

ANSV believes that some of the information claimed by ATR are already included in the report, even if reported in a different form as they would have preferred; rationale behind other ATR proposals were not agreed by ANSV, hence the report was not amended.

It is important to note that revision of the JIC RAI for the FQI, as already stated in the report, was made by ATR by its own initiative, as further preventive measure, in April 2006 for the ATR 72 (in February 2006 for the ATR 42 type aircraft) and it would not seem that JIC revision was done following or in reply to ANSV safety recommendation (ANSV-7/443 05/2/A/05).

The status of the said recommendation, addressed to EASA, is still open.

4. Specific remarks on DGAC Tunisia comments

ANSV is the competent authority to conduct the investigation on ATR 72, TS-LBB. ANSV conducted it since the day of the accident.

The supposedly rights of Tunisia as State of Registry and Operator to conduct the investigation is not acceptable. On the basis of available evidences, given by Italian Navy and Italian Maritime Authorities, the aircraft ditched within Italian territorial waters.

Initial comments to the ANSV's draft final report, sent by DGAC Tunisia, were thoroughly discussed in specific meetings, as reported in the Synopsis. Some DGAC Tunisia proposals for change were agreed and the report was amended accordingly; others proposals were not agreed and thus not included and reasons for that were given directly to DGAC representatives during the said meetings.

ANSV would like to highlight that the banning of an air transport operator is not within ANSV power, as it is for any other purely investigation authorities. Anyway, DGAC Tunisia statement regarding the banning of Tuninter and the alleged "major prejudice to the operator" determined by ANSV investigation process is not true and cannot be accepted.

5. Specific remarks on Transportation Safety Board Canada comments

ANSV did not receive any remarks from TSB Canada on the final report. Transport Canada found it to be technically accurate.

APPENDIX

1. TSB Canada comments
2. BEA France comments
3. DGAC Tunisia comments, received through the Embassy of Tunisia in Rome.

Transportation Safety Board
of Canada



Bureau de la sécurité des transports
du Canada

200 Promenade du Portage
Place du Centre, 4th Floor
Gatineau, Quebec
Canada K1A 1K8

Our file / Notre référence

825-A05F0130

07 December 2007

Agenzia Nazionale Per La Sicurezza Del Volo
Via Attilio Benigni,
53 - 00156 Roma
Italy

To the attention of : Mr. Vincenzo Pennetta

**Re : Canada State Comments - Accident involving ATR 72-202, registration TS-LBB
operated by Tuninter, 06 August 2005, off-shore Palermo Airport, Sicily - Italy,
06 October 2005**

Dear Mr. Pennetta :

Thank you for providing Canada, as the State of Manufacture of the occurrence aircraft engine, with the opportunity to comment on the subject Draft Final Report. The Transportation Safety Board of Canada has no state comments to make on this report. Attached you will find comments from Transport Canada and Pratt & Whitney Canada for whatever action you may deem appropriate.

I look forward to receiving your Final Report on this investigation.

Sincerely,

Joe Jackson
Acting Director, Air Investigations

Attachments : Transport Canada comments, dated 29 November 2007
Pratt & Whitney Canada comments, dated 07 December 2007

Canada



Transport
Canada
Civil Aviation

Transports
Canada
Aviation Civile

Tower C, Place de Ville
5th Floor
330 Sparks Street
Ottawa, Ontario
K1A 0N8

Tour C, Place de Ville
5^e étage
330, rue Sparks
Ottawa (Ontario)
K1A 0N8

NOV. 29 2007

Your file Votre référence

Ms. Elaine Summers
Senior Technical Investigator
Transportation Safety Board of Canada
200 Promenade du Portage
Place du Centre, 4th Floor
Gatineau, Quebec
K1A 1K8

Our file Notre référence
AARQ 5002-A05F0130
RDIMS 3736556
TSB2007G104278

Dear Ms. Summers:

**SUBJECT: ANSV Draft Aviation Investigation Report (TSB file A05F0130)
Ditching off the Coast of Capo Gallo
Tuninter
ATR 72 TS-LBB
Palermo, Sicily
06 August 2005**

This is in response to your message of October 18, 2007, requesting departmental comments on the subject report. The appropriate officials have reviewed the report and have found it to be technically accurate; therefore, no comments are provided for the Board's consideration.

Should ANSV officials have any questions concerning this response, please contact Mr. Jim McMenemy of Aviation Safety Intelligence at 613-990-2142.

Yours sincerely,

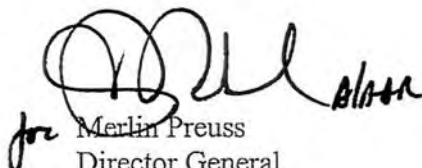
 Merlin Preuss
 Director General
 Civil Aviation

Canada



BEA
Bureau d'Enquêtes et d'Analyses
pour la sécurité de l'aviation civile

BEA comments on ANSV Draft Final Report on the accident involving ATR 72 aircraft TS-LBB ditching off the coast of Capo Gallo (Palermo, Sicilia), Aug. 6th, 2005

BEA participation in the technical investigation :

In the synopsis, it is stated that :

“The Agenzia Nazionale per la Sicurezza del Volo (...) conducted the investigation in conformity with Annex 13 of the Convention on International Civil Aviation”.

Annex 13 to the Convention on International Civil Aviation (The Chicago Convention) sets out *inter alia* the 'International Standards and Recommended Practices' for the conduct of an aircraft accident investigation. The European Council Directive 94 / 56 / EC, which came into force on 21 November 1994, established the fundamental principles governing the investigation of civil aviation accidents and incidents within the European Union States. This Directive embodied the provisions of Annex 13 into European legislation.

France, as the State of Design and Manufacture of the ATR aircraft, had rights of participation in the investigation as laid down in Annex 13 to the Chicago Convention and EU Directive 94 / 56 / EC.

France appointed an Accredited Representative and Advisors from the Bureau d'Enquêtes et d'Analyses pour la sécurité de l'aviation civile (BEA) to participate in the investigation conducted by the *Agenzia Nazionale per la Sicurezza del Volo (ANSV)* under the provisions of the 'Convention' and the 'Directive'. The French Accredited Representative also appointed Technical Advisors representing the organizations with design responsibility for airframe and equipment and who were thus the best qualified individuals to assist in the investigation.

The Italian judicial authorities conducted a separate inquiry into the accident in parallel with the ANSV investigation. The manner in which the judicial investigation was conducted presented major impediments to the BEA's participation in the technical investigation.

The difficulties encountered are listed below.

The Italian judicial authorities did not allow the BEA Investigators to examine any items of the wreckage (Annex 13 Chapter 5. 25b) or to participate in component examinations (Annex 13, Chapter 5. 25g).

For example, the judicial authorities:

- a. Did not allow the BEA investigators to examine the wing nor the content of the tank.
- b. Did not allow the BEA investigators to participate to the examination of the onboard computers.
- c. Did not allow the BEA investigators to examine the engines.



d. Did not allow the BEA investigators to be systematically involved in the examination of evidence.

The Italian judicial authorities did not allow the BEA Investigators full access to all relevant evidence as soon as possible. (Annex 13 Chapter 5. 25d).

For example, the judicial authorities:

- a. Did not involve the BEA investigators to participate in the recorder and wreckage research.
- b. Did not grant access to recorders readout nor to the raw data or to the content of CVR information within a reasonable delay.
- c. Did not invite the BEA investigator to the operational flight simulation.

The BEA regrets that it has not been associated in a cooperative way to the technical investigation but is aware that it was mostly due to judicial authorities constraints. These constraints induced unnecessary delays and could, in some circumstances, have detrimental consequences on the identification and dissemination of critical safety information.

In addition, the BEA regrets that it was not involved in the writing of ANSV early safety recommendations (1, 2 and 3) addressed to EASA, and that it has not received, at that time, all the background information that led to issuance of these recommendations by ANSV.

These obstructions to France participation were in contravention with the State of Occurrence's obligations under the Chicago Convention (Annex 13). It is also in contravention of the European Council Directive 94 / 56 / EC which states "*investigators should be able to complete their tasks unhindered*".

Technical comments :

As stated in ATR comments (N° 1, 2, 7), we would suggest to recall the purpose of the Job Instruction Card (JIC) which is not to check whether the equipment is appropriate or not but to give a detail procedure to reinstall the same equipment (same P/N). The Illustrated Part Catalog (IPC) is the only reference to check the applicability of different Part Numbers (PN).

The BEA does not support the integration of a new ditching procedure « with engine » versus « no engine ». As stated by ATR there is no reason for the crew to adjust the power to reach a specific touch down zone when ditching, considering that anyway, the present procedure requests to shutdown both engines and to feather the propellers at 200 feet. This is an emergency procedure that should be performed using basic pilot skills and experience to manage flight with minimal energy at impact. The application of a new procedure in such a high work load environment could confuse crews and possibly reduce crew performance.

An Alenia Aeronautica and EADS joint venture



TO: BEA /ANSV

ATTEN: Messrs. P.L. ARSLANIAN,
R. JOUTY, Y. TORRES,
L. SARTORIUS (BEA)

CC: C.ORSI, (ATR)

ATR Continued Airworthiness

FAX:

PHONE:

REF: DO/TC 5346/07

FROM: G. CALDARELLI

FAX: 00 33 5 6221 6718

PHONE: 00 33 5 6221 6150

DATE: 7/12/01

N° PAGES: 7

**SUBJECT : ATR 72-202 TS-LBB accident occurred the 5th of August 2005
FINAL DRAFT REPORT ISSUED BY ANSV**

Dear Sir,

I received the draft of the FINAL REPORT issued by the ANSV of Italy of the accident occurred the 5th of August 2005 to the ATR 72-202 TS-LBB.

I send hereunder the comments to the report, as contribution to the final version of the Report.

GENERAL STATEMENTS

- The investigation has been performed by ANSV and ATR had been appointed as technical advisor of Accredited Representative of BEA.
- ATR did not participate to the whole investigation activities because was not made aware of the investigation activities going on.
- The ATR contributions have been:
 - Technical advisor for fuel sampling collection from wing tank.
 - Provide the flight simulator equipment without crew to the ANSV to study the crew flight management from the first engine out to the ditching.
- ATR asked to all operators to inspect the correct installation of FQI as soon as it was discovered the incorrect installation. (See: ANSV-6/443-05/1/A/05)
- ATR has made the removal and installation of the FQI even more robust toward non-correct operations. The JIC (Job Instruction Card) for removal and installation already required a test of the FQI after installation. Since February 2006 requires also the application of an already existing JIC for check of coherence, which is performed by mean of dipsticks, of fuel quantity indicated on the FQI and the physical quantity of fuel in the tanks. It is to be noted that if qualified personnel

performs the replacement then this further barrier would be unnecessary because the correct P/N would have been checked before installation. (See: ANSV-7/443-05/2/A/05).

- ATR since 1997 has developed, according to certification requirements for ETOPS operation, the second low-level alert, which is independent from the fuel indication system. The technical solution was made available to all operators of in service aircraft with recommended service bulletins: for ATR 42 as per SB ATR42-28-0033 of 12 July 1997 and for ATR-72 as per SB ATR72-28-1013 of 14 December 1998.
The same solution was introduced for production standardization in newly delivered aircraft since October 1997 for ATR 72 from serial number 529 and since May 1998 for ATR 42 from serial number 561. (See: ANSV-13/443-05/3/A/05).
- The FQI part number is defined by FQI manufacturer and is reported within aircraft IPC Illustrated Part catalog. All wrong manipulations or incorrect writing made outside ATR are not monitored by ATR.

COMMENTS TO THE REPORT

1. Page 3 of report:

Report Sentence: 1.1.1 end of paragraph

"In accordance with the ATR maintenance manual applicable at the time, the replacement procedure did not require any manual checks, using the so-called dipsticks, of the actual quantity of fuel present in each tank, or the subsequent comparison with the value shown by the FQI".

Proposal:

delete

Reason for change:

The Job Instruction Card (JIC) is not made for checking the correct P/N. The correctness of P/N must to be made by using the IPC. The JIC has been enhanced by ATR since February 2006 and is now in line with ANSV recommendation (See ANSV-7/443-05/2/A/05).

2. Page 6 of report:

Report Sentence: 1.1.2 end of paragraph

"The technician responsible for replacing the part removed the faulty FQI P/N 748681-2, S/N 179 from TS-LBB and replaced it with the P/N 749-158, S/N 238 indicator, following the detailed instructions of the Job Instruction Card JIC 28-42-81 RAI 10000 (procedure set by the ATR manufacturer for the replacement of the part - Annex C), which did not require any checking on the correctness of the information provided by the device, but only the testing of the lights of the display after fitting."

Proposed Sentence:

"The technician responsible for replacing the part removed the faulty FQI P/N 748681-2, S/N 179 from TS-LBB and replaced it with the P/N 749-158, S/N 238 indicator without checking the P/N with the aircraft manufacturer documentation IPC and not using the detailed instructions of the Job Instruction Card JIC 28-42-81 RAI 10000 (procedure set by the ATR for the replacement of the part - Annex C)."

Reason for change:

The Job Instruction Card (JIC) is not made for checking the correct P/N. The correctness of P/N must to be made by using the IPC. The JIC has been enhanced by ATR since February 2006 and is now in line with ANSV recommendation (see ANSV-7/443-05/2/A/05).

3. Pag 40 of report:

Report Sentence: 1.6.5.2

"The ATR 42 and ATR 72 type FQIs are identical in their dimension and installation procedure. Therefore an ATR 42 type FQI can be installed by mistake on an ATR 72 aircraft and vice versa. The only difference between the two FQIs, when installed on the aircraft, is white lettering indicating the maximum fuel quantity for each wing fuel tank. This can be found on the front of the instrument and is "2500 Kg" for the ATR 72 type FQI and "2250 Kg" for the ATR 42 type."

Proposed revised Sentence:

"The ATR 42 and ATR 72 type FQIs are identical in their dimension and installation modalities. However, the differences between the two FQIs are:

(i) Normalized white lettering indicating the maximum fuel quantity for each wing fuel tank. This can be found on the front of the instrument and is "2500" for the ATR 72 type FQI and "2250" for the ATR 42 type, and

(ii) the equipment Part Number located on the top of the equipment." Therefore, an ATR 42 type FQI may be wrongly installed by mistake on an ATR 72 aircraft and vice versa only when the P/N is not checked by reference to the IPC and when the relevant JICs checks are not applied. "

Reason for change:

The second sentence of the paragraph must be revised to prevent misleading information and rectify the identification purpose of the Part Number. The external shape, color and aspect do not guarantee that the part will fulfill its intended function, but the P/N does.

4. **Page 137**

Report Sentence: 1.16.5.1.2.

"in real conditions (...) the test pilots would very probably have opted to bring the aircraft down into the sea, where there is a better chance of limiting damage to aircraft and passengers than when making a forced landing on irregular ground (...)"

Proposed revised Sentence: delete

Comments:

This sentence is not factual, the pilot never had this choice: water or irregular ground. It is always better to land on the runway rather than to make a ditching.

5. **Page 137 of report:**

Report Sentence: 1.16.5.1.2.

"Considerations: indeed, the tests conducted proved that it was difficult to maintain an optimum speed profile,"

Proposal: delete

Comment:

Speed variations of + or -5 kts around the VMLB - which is the optimum descend speed - do not reduce or increase the range. In fact the aircraft aerodynamic variations around VMLB speed have negligible effect.

6. **Page 154 of report:****Report Sentence:** 1.18.4.3.

"The ditching procedures is set in the aircraft's technical and operating documentation(...) and refers to general system operating conditions (...). Indeed, the procedure does not specify the causes necessitating ditching (...)".

Comment:

There is no substantial difference between ditching with or without engine running. Engine power can help in choosing closer or longer the impact point on the trajectory but this is not important on the water where no runway threshold exists. All aircraft FCOM's are made with this concept.

7. **Page 153 of report:****Report Sentence:** lines 2-9

"The Job Instruction Card (JIC) applicable on the date of the occurrence (Appendix C) for the replacement of the FQI did not prescribed either a check on congruity between the FQI readings and the data entered in the aircraft records or a check to establish whether the FQI readings before and after replacement were the same/consistent. It only prescribed ensuring that the post-installation test designed to light up the LO LVL warning light and all the LEDs on the two FQI displays had been carried out. Nor did the JIC require the accuracy of the instrument reading to be checked using the dipsticks inserted into the undersides of the wings."

Proposed sentence:

"The Job Instruction Card (JIC) applicable on the date of the occurrence (Appendix C) for the replacement of the FQI did prescribe to ensure that the post-installation test designed to light up the LO LVL warning light and all the LEDs on the two FQI displays had been carried out (by reference to the JIC TST 28-42-00 TST 10 000). JIC 28-42-81 RAI 10000 calls for FQI electrical check (digits and low level lights) to insure proper connection between airframe and equipment."

Comment:

The Job Instruction Card (JIC) is not made for checking the correct P/N. The correctness of P/N must to be made by using the IPC. The JIC has been enhanced by ATR since February 2007 with a link to an existing JIC for checking the coherence of the fuel indicated on the FQI and the quantity in the tanks measured with dipstick. This JIC is also in line with ANSV recommendation (See ANSV-7/443-05/2/A/05).

8. **Page 191 of report:****Report Sentence:** 2.5

"The ditching procedure given in ATR 72 manuals, as usually given for other aircraft types, is structured so the crew can normally rely on engine power to perform the final control of parameters fundamental for aircraft flight. As shown in previous Chapter I, paragraph 1.18.3.3, it is in fact required that, in the last 200 ft, to feather the propellers, close the engine fuel feed valves and to operate the fire extinguishers in the engines. This operation should prevent fire breakouts during impact. The ditching manoeuvre is per se an emergency manoeuvre and, if performed without engine thrust in the approach phase, it is quite difficult to complete it adequately. It is extremely difficult to choose the optimum heading compared to the wave motion, to set the aircraft in the ideal attitude without losing control, not having the engine thrust available."

Proposed sentence:

"The ditching procedure given in ATR 72 manual is as usually given for other aircraft types. It is required, in the last 200 ft, to feather the propellers, close the engine fuel feed valves and to operate the fire extinguishers in the engines. This operation should prevent fire breakouts during impact."

Comment:

As evidenced by the statement the engines must be shut off and the propellers must be feathered. This means no engine running in case of ditching even when engine are available. There is no difference for a ditching with or without engine thrust because there is not a target landing point such as runway threshold. Consequently, it is incorrect to state that the ditching procedure given in ATR 72 manuals is structured so the crew can normally rely on engine power.

9. **Page 192 of report:****Report Sentence:** 2.5 end of paragraph

"Therefore it is advisable to integrate information available in FCOM and QRH emergency procedures, in order to consider also the possibility of ditching without thrust from both engines."

Proposal:

Delete

Comment:

One procedure is enough and it is complete.

10. **Page 208 of report:****Report Sentence:** lines 1-5

"Inadequate manufacturer's control procedures, concerning FQI replacement".

Proposal:

Delete " manufacturer" because not applicable

Reason for change:

First Manufacturer does not have control procedure for FQI replacement. The aircraft manufacturer gives the sequence of action to fulfill to replace correctly equipment. The Manufacturer also gives the list of equipment, which can be installed on each aircraft model this document is the IPC. The control is made on site by operator organization.

Giuseppe Caldarelli

ATR Certification, Continued Airworthiness,
Maintenance Engineering and Safety



RÉPUBLIQUE TUNISIENNE
MINISTÈRE DE TRANSPORT
 Direction Général de l'Aviation Civile

03535

December 6, 2007

M. BRUNO FRANCHI
 President
 ANSV

Dear Sir,

Further to Draft Final report submitted December the 4th, 2007 by Italian ANSV we first of all would like to reiterate, that according to data communicated early this year and available in Mr [omissis] and Mr [omissis] reports, the accident occurred in international water and thus the investigation have to be conducted by state of registration of the aircraft; in this specific case Tunisia.

Even though Italy, in accordance, with article 38 of ICAO convention, had notified ICAO of non existence of any difference with annex 13; during the investigation process, the ANSV has not observed International Civil Aviation Convention Annex 13 rules especially provision of articles 5.3 and 5.25. For instance, accredited representative of Tunisia has not been allowed to participate to investigation process; CVR was made available to media...

It should be reminded that, in the beginning of investigation process, ANSV has claimed that Tunisian Authority was shackling investigation process and Italian authority have banned TUNINTER further to first ANSV findings and recommendations. As far as we know, such an action has never been taken after any accident before.

On the other hand, neither Annex 13 paragraph 4.2 g and k nor annex 13 Paragraph 4.4 were observed by ANSV.

"Format and content

4.2 The notification shall be in plain language and contain as much of the following information as is readily available, but its dispatch shall not be delayed due to the lack of complete information:

[...]

g) position of the aircraft with reference to some easily defined geographical point and latitude and longitude;

j) an indication to what extent the investigation will be conducted or is proposed to be delegated by the State of Occurrence;

[...]"

"Additional information

4.4 As soon as it is possible to do so, the State of Occurrence shall dispatch the details omitted from the notification as well as other known relevant information".

In this context, it must be emphasized that some information is different from previously communicated by ANSV and Italian justice ones particularly when dealing with the impact and wreckage coordinates. One shall bear in mind the annex 13 paragraph 5.3 and 5.3.1:

"5.3 When the location of the accident or the serious incident cannot definitely be established as being in the territory of any State, the State of Registry shall institute and conduct any necessary investigation of the accident or serious incident. However, it may delegate the whole or any part of the investigation to another State by mutual arrangement and consent.

5.3.1 States nearest the scene of an accident in international waters shall provide such assistance as they are able and shall, likewise, respond to requests by the State of Registry."

Moreover and according to ANSV, it was impossible to stick to annex 13 rules as judicial authorities did not recognize the right granted by annex 13 paragraph 5.25 and 5.27:

« Participation

5.25 Participation in the investigation shall confer entitlement to participate in all aspects of the investigation, under the control of the investigator-in-change, in particular

to:

a) visit the scene of the accident;

b) examine the wreckage;

c) obtain witness information and suggest areas of questioning;

d) have full access to all relevant evidence as soon as possible;

e) receive copies of all pertinent documents;

f) participate in read-outs of recorded media;

g) participate in off-scene investigative activities such as component examinations, technical briefings, tests and simulations;

h) participate in investigation progress meetings including deliberations related to analysis, findings, causes and safety recommendations; and

i) make submissions in respect of the various elements of the investigation.

However, participation of States other than the State of Registry, the State of the Operator, the State of Design and the State of Manufacture may be limited to those matters which entitled such States to participation under 5.23. »

"Rights and entitlement

5.27 A State which has a special interest in an accident by virtue of fatalities or serious injuries to its citizens shall, upon making a request to do so, be permitted by the State conducting the investigation to appoint an expert who shall be entitled to:

a) visit the scene of the accident;

b) have access to the relevant factual information;

c) participate in the identification of the victims;

d) assist in questioning surviving passengers who are citizens of the expert's State; and

e) receive a copy of the Final Report"

According to above mentioned facts, it became obvious that ANSV, in total violation of international civil aviation convention, did not take into consideration the right of Tunisia as the state of registration to conduct this investigation. Furthermore ANSV did not have any procurement or habilitation from Tunisian authority to lead this investigation.

It is also pertinent to remind that banning TUNINTER, further to preliminary investigation conclusions, is a serious precedent violating annex 13 paragraph 3.1 which states:

"3.1 The sole objective of the investigation of an accident or incident shall be the prevention of accidents and incidents. It is not the purpose of this activity to apportion blame or liability."

Thus the objective of the investigation process was not observed by ANSV causing major prejudice to the operator even though that all data was provided by Tunisia accredited representative before this banning in conformity with annex 13 rules.

It's crucial to remind that during the investigation process, and in contradiction to what ANSV declared in the beginning, Tunisian authorities had strictly respected annex 13 standards and would have wished similar attitude.

The Tunisian accredited representative was not allowed to use the rights provided by paragraph 5.25 of ICAO annex 13.

Therefore, and considering the above mentioned facts about non respect of annex 13 rules (Particularly 3.1, 4.2, 5.3, 5.3.1, 5.25, and 5.27) by ANSV: it's established that:

- ANSV is not competent to conduct this investigation
- Above mentioned report is null and void.

Best regards,

Le Directeur Général de l'Aviation Civile

Hamadi BEN KHELIF

H. Ben Khelif



Copy : Secrétaire général de l'Organisation de l'Aviation Civile Internationale.

(Nota trasmessa dall'Ambasciata di Tunisia a Roma)

Traduzione non ufficiale

Le riserve espresse dalla parte Tunisina riguardanti le procedure seguite dalla parte italiana in occasione dello svolgimento dell'inchiesta tecnica e dell'elaborazione del progetto di relazione riguardante l'incidente dell'aereo della TUNINTER avvenuto il 6 Agosto 2005

Le disposizioni dell'allegato 13 della Convenzione di Chicago relative all'aviazione civile internazionale	Le differenze riscontrate rispetto alle disposizioni dell'allegato 13 della Convenzione di Chicago
<p>Articolo 5.3: Quando risulta impossibile stabilire con certezza che l'incidente oppure il luogo dell'incidente grave si trova sul territorio di un qualsiasi Stato, lo Stato di immatricolazione aprirà e svolgerà ogni inchiesta necessaria sull'incidente oppure sul fatto grave accaduto. Tuttavia, esso potrà delegare la condotta dell'inchiesta nel suo insieme oppure in parte ad un altro Stato per accordo e unanime consenso.</p>	<p>Tenuto conto dell'incertezza dei coordinate geografiche del luogo dell'incidente presentate dalla parte italiana e verificate dalla parte tunisina, lo Stato Tunisino in quanto Stato di immatricolazione dell'aereo dovrebbe essere dichiarato competente per svolgere l'inchiesta nonché elaborare il rapporto.</p>
<p>Articolo 5.25: La partecipazione all'inchiesta darà la facoltà di partecipare a tutti gli aspetti dell'inchiesta, sotto il controllo dell'inquirente designato, e in particolare di:</p> <ul style="list-style-type: none"> a) visitare il luogo dell'incidente; b) esaminare il relitto; c) ottenere informazioni da parte dei testimoni e di proporre soggetti di interrogazione; d) avere libero accesso ad ogni informazione utile, il più presto possibile; e) ricevere copie di tutti i documenti pertinenti; f) partecipare alla lettura delle registrazioni; g) partecipare alle attività d'inchiesta al di fuori dei luoghi dell'incidente quali gli esami degli elementi, gli esposti tecnici, le prove e simulazioni; h) partecipare alle riunioni sull'avanzamento dell'inchiesta e, in particolare, alle deliberazioni che vertono sull'analisi, le conclusioni, le cause e le raccomandazioni di 	<p>Il rappresentante accreditato della Parte tunisina presso la commissione d'inchiesta tecnica italiana, non è stato autorizzato a partecipare alla maggior parte delle tappe delle investigazioni e dell'inchiesta. Non è stato autorizzato, altresì, ad avere accesso agli elementi ed informazioni utili all'inchiesta.</p>

<p>sicurezza;</p> <p>i) fare suggerimenti riguardo ai vari elementi dell'inchiesta;</p> <p>rimanendo inteso, però, che la partecipazione degli Stati diversi dallo Stato d'immatricolazione, lo Stato del gestore, lo Stato di concezione e lo Stato di costruzione può essere limitata alle questioni che hanno dato a codesti Stati la facoltà di partecipare all'inchiesta in virtù delle disposizioni dell'art. 5.23</p>	
<p><i>Non divulgazione degli elementi</i></p> <p>Articolo 5.12: Lo Stato che conduce l'inchiesta su un incidente non comunicherà nessuno degli elementi descritti di seguito ad altri fini che quelli dell'inchiesta sull'incidente a meno che l'autorità incaricata e l'amministrazione della giustizia nello Stato in questione non decida che la loro divulgazione sia più importante che le incidenze negative che tale misura potrebbe avere, ai livelli nazionale ed internazionale, sull'inchiesta oppure su ogni altra ulteriore inchiesta.:</p> <p>a) tutte le dichiarazioni ottenute da persone da parte dei servizi d'inchiesta nel corso delle loro investigazioni;</p> <p>b) tutte le comunicazioni tra persone che hanno partecipato allo sfruttamento dell'aeronave;</p> <p>c) informazioni di ordine medico e privato riguardanti le persone coinvolte nell'incidente;</p> <p>d) registrazioni delle conversazioni nella cabina di pilotaggio e trascrizioni di tali registrazioni;</p> <p>e) registrazioni e trascrizioni delle registrazioni provenienti dagli organismi di controllo del traffico aereo;</p> <p>f) opinioni espresse nel corso dell'analisi delle informazioni ivi comprese le informazioni fornite dai registratori di bordo.</p>	<p>Alcuni elementi tra cui, in particolare, le registrazioni delle conversazioni della cabina di pilotaggio, sono state pubblicate dai media italiani (TV, Internet, giornali...)</p>
<p>Articolo 5.4. Il servizio d'indagine sugli</p>	<p>L'ANSV, che ha svolto l'inchiesta tecnica,</p>

<p>incidenti deve poter svolgere l'inchiesta in totale indipendenza e senza restrizioni, in accordo con le disposizioni del presente allegato. L'inchiesta comprenderà:</p> <ul style="list-style-type: none"> a) la raccolta, la registrazione e l'analisi di tutte le informazioni disponibili relative all'incidente in questione; b) se occorre, la formulazione di raccomandazioni sulla sicurezza; c) se possibile, la determinazione delle cause; d) la stesura della relazione finale; e) Quando sarà possibile, occorrerà ispezionare i luoghi dell'incidente, esaminare il relitto e prendere nota delle dichiarazioni dei testimoni. 	<p>ha utilizzato analisi e conclusioni effettuate da altri organismi (incompetenti per svolgere l'inchiesta tecnica).</p>
--	---

NB: Lo Stato Italiano ha adottato l'allegato 13 della Convenzione di Chicago relativa all'aviazione civile internazionale nella sua totalità senza alcuna riserva o notifica di differenza.