

2.3.6.18 On the third and fourth segments, during which the crew started to follow the chart for approach to runway 28, the navigator was very busy dealing with the radio communication with the AFIS officer, in addition to making the necessary preparations and navigating the aircraft laterally. Within a period of three minutes, one and a half minutes of his time were occupied by listening to and answering the external radio communication (all in all 17 exchanges). In addition, the received information had to be evaluated and as it was in a foreign language, this required more time than usual. Due to the inadequate preparations for this approach, the navigator was forced to navigate in a desynchronized reasoning mental mode, resulting in his perceptions becoming fragmented and incomplete, as well as leading to a situation when he was 'mentally behind' the aircraft. Having to deal with the communication and controlling the aircraft complicated the situation and, as pointed out previously, gave him little opportunity to check his calculations and actions.

2.3.7 The fifth segment 08:19:06 hrs - 08:22:23 hrs (3 min 17 sec, completion of the turn to final - impact).

2.3.7.1 At 08:19:11 hrs on a heading of about 300°, the PiC gave the command to get out of the turn: 'Let's level out', and three seconds later: 'No (?it should be) to the right', indicating that he wanted a correction to the right. However, the FDR shows that the turn continued another 10° and the aircraft was rolled out on heading 290° immediately followed by a corrective turn to the right. This was obviously a reaction to the repeated orders from the PiC at 08:19:19 hrs: 'To the right' and one second later: 'Let's turn to the right'. These statements indicate that the navigator was controlling the lateral navigation of the aircraft by the Autopilot Turn knob once again. During these seconds, statements from the navigator also tell something about the situation. At 08:19:16 hrs, he told the crew that he expected the situation to clear up: 'Just we'll get it, just now'. However, still a little uncertain, he asked: 'Is the mark (marker) to the right?' to which the Co-pilot answered: 'No, it is still staying.' Most likely the mark (marker) mentioned belonged to the CDI on the HSI and was still staying at the full left deflection and therefore indicating correctly in relation to the LLZ centerline. On the other hand, if he meant the mark (marker) on the GPS, it should have been on the left, provided the GPS had been programmed with an inbound course of 283°.

2.3.7.2 Δ 15 An additional factor of significance at this point was that the crew was not familiar with the possibility of checking the ambiguous navigational information indicated on their instruments by the outside source available, namely the VDF service that would supply the magnetic course to the airport. This information was neither in the Jeppesen approach chart manual nor on the diskette supplying the navigational information for the GPS. The Jeppesen policy of not presenting secondary information and the general lack of confidence in the information in AIPs prevented the crew from being able to solve their confusion.

- 2.3.7.3 To the PiC's mind, the correct way to make a corrective turn was to the right at this point and the navigator turned the aircraft to, and maintained a heading of, 306°. Adding the wind drift, the aircraft track slowly increased the distance to the LLZ centerline.
- 2.3.7.4 At 08:19:21 hrs, the radio altimeter warning was again recorded by the CVR, indicating that the aircraft passed above the mountain Møysalen. Because the aircraft was still maintaining the safe altitude of 5 000 ft, this again was no cause for alarm to the crew.
- 2.3.7.5 Δ 11 It is a known fact that crews are subject to nuisance warnings when they know they are safe, and will tend to ignore the same warning when it is real. It has also been demonstrated that a crew in a stressed working situation might shut out even intense warning sounds completely.
- 2.3.7.6 As the radio altimeter warning signal started, the PiC, trying to solve the situation, asked for the approach chart from the co-pilot. Around this time, the crew could possibly see that the desired track of 283° appeared in the upper right-hand corner of the GPS display. This was reassuring enough for the two pilots to think about starting the descent. But at 08:19:51 hrs, the Navigator protested: 'But it's fourteen here.' The correction was accepted by the PiC and the aircraft continued at 5 000 ft. Eight seconds later the Navigator stated the rate of descent: 'Five meters', which the co-pilot was to establish when leaving 5 000 ft for the final approach.
- 2.3.7.7 At 08:20:03 hrs, the Navigator asked for approval to turn to 320°: 'So, I'll keep 320°, OK?'. The Co-pilot asked if that was enough: 'Isn't that too little?' and the Navigator stated the necessity of having to make a correction: 'It should be a corrective turn'. The PiC obviously disagreed in making a significant turn to the right and ordered: 'No! Turn to the left!' Six seconds later, he was supported by the co-pilot and, according to the FDR, the aircraft was turned to the left from heading 306° in accordance with the PiC's orders. Seven seconds later, the aircraft was rolled out of the turn on heading 291°. In the meantime, at 08:20:21 hrs, the Navigator most likely read the DME to be 13 NM and stated so: 'It's thirteen. Let's descend!' and, four seconds later, he said: 'Three degrees, five minutes. We're on the glide path.' The altitude parameter on the FDR readout confirms that the aircraft had started the final descent at this time.
- 2.3.7.8 On final approach, when the navigator wanted to make a significant correction to the right, while the two pilots agreed that the turn should be to the left, this disagreement again reveals something of the crew's lack of situational awareness. It is the opinion of the Boards that the indications of the two navigational aids - the HSI and the GPS - governed the situation since it is not very likely that the crew members took that much notice of the RMI needle pointing to LON. The GPS programmed with an approach course of 283° must have been the indication that governed the opinion of the navigator and made him ask for permission for the

substantial heading change to 320° just before the descent.

- 2.3.7.9 Δ 16 The GPS is not permitted as a primary approach aid and should not be utilized as one. It is understandable that the crews of the airline had built confidence in it due to its demonstrated accuracy. It is, however, quite hazardous to assume that a GPS displayed indication must be the correct one, unless it is confirmed by another source.
- 2.3.7.10 On the other hand, the position of the CDI on the HSI must have convinced the PiC and perhaps the co-pilot as well that they now were to the right of the centerline and the corrective turn should be to the left. The navigator obviously carried out the order, but a heading of 291° was barely enough to take care of the wind drift and certainly not enough to intercept the centerline of the LLZ. The aircraft therefore flew parallel to the centerline only.
- 2.3.7.11 Δ 17 The crew started descent in mountainous terrain without firm and positive control of the lateral navigation demonstrated by the disagreement within the crew whether to correct left or right. A crew might enter a state of mind in which they continue, expecting everything to fall into place soon, based on their previous flying experience. The crew members, being used to service high traffic-density airports, where missed approaches inevitably lead to delays and inconvenience, could partly explain this. However, the traffic situation at Svalbard Airport Longyear that day was certainly no reason not to abandon the approach. The descent continued.
- 2.3.7.12 Δ 18 When the Co-pilot at 08:20:29 hrs found it necessary to ask: 'We're on landing course now, correct?' it was another cause for alarm. This is quite disturbing since the aircraft was now descending in a mountainous area on an approach where keeping close to the approach centerline is an absolute safety requirement. The Boards, again, find it necessary to emphasize that, if there is the slightest uncertainty of the aircraft position under such circumstances, it is reason good enough to abandon the approach, climb to a safe altitude and then solve the problem.
- 2.3.7.13 Four seconds later, when the aircraft just had been rolled out on heading 291°, the PiC obviously saw the need to make a further correction to the left and ordered: 'To get to the landing course, make a slight correction to the left!' Again the HSI with the CDI to the left must have been the instrument telling him they were too far to the right. However, no such turn was made. The navigator continued heading 291°. About this time according to the reconstruction of the track flown the aircraft departed the 10° sector to the right of the LLZ centerline outside which the localizer is not to be used.
- 2.3.7.14 Δ 19 The aircraft departed the ±10° usable sector of the localizer, but the radiation from the antenna is still well above field strength minimum. There is a

warning about this limitation on the chart, but is not very well highlighted. The Boards consider that this limitation could be overlooked in a stressed situation. In this case, the CVR recorded the crew expressing their feelings about an odd approach. We will never know if their resentment comprised the user limitation, but, due to the importance of this limitation, the Boards recommend that the appropriate authority assess the presentation and look for a solution that is more conspicuous.

- 2.3.7.15 At 08:21:00 hrs, we receive confirmation yet again that the navigator was controlling the aircraft laterally when the PiC said: 'You guide us, you guide us!' and the Navigator immediately acknowledged this by stating: 'We're flying by Jeppesen'. Two seconds later, the PiC wanted to check the position in relation to ADV and asked the navigator to select Advent for him. But the navigator did not obey him, probably because he had the distance to the airport on the DME as well as on the GPS and answered at first: 'Not now. Later on!' and secondly: 'I've told you, there is no need'. It is possible that the PiC could have had an indication of how far away the aircraft was tracking in relation to the ADV by watching how fast the RMI needle was moving, but it is more likely that he wanted to check how far they had come because the AFIS officer had asked for a new position report abeam Advent or at eight miles inbound.
- 2.3.7.16 Δ 20 Even though the selection of ADV instead of LON was not a crucial event, the Boards would point out that it is good airmanship to make full use of all the available approach aids. The other ADF receiver was available and the crew could have had both LON and ADV available at the same time. The testflying demonstrated that the RMI needles gave a good check of the centerline, needle no. 1 indicating the same bearing as needle no. 2, except close to the antenna. On the track flown by VKO 2801, the two ADFs set up like this would have given a clear indication of a track to the right of the centerline, which was also demonstrated during the test flight.
- 2.3.7.17 At 08:21:19 hrs, an Unidentified crew member (most likely the Navigator) said: 'To the right,' but the PiC expressed his concern by asking: 'What is our radial?' The Navigator then indicated that they were following the approach chart and stated: 'Let's follow the approach chart to the end!' The FDR information shows that a slight turn to the right was carried out and at 08:21:24 hrs, the aircraft was heading 300°.
- 2.3.7.18 Δ 18 The concern of the PiC is illustrated by the physiological-acoustic analysis of this phrase which shows that he experienced the highest increase in emotional stress found in the crew. (Of all the phrases that were analysed by the IAC.) A pronounced increase in the emotional stress was also found in the phrase uttered by the Unidentified crew member (the Navigator?) - 'To the right.' To the Boards it seems that the mental operative mode of the PiC and the navigator, as well as their stress levels, made it difficult for them to assess the situation they were in (including the level of danger) in an objective and

integrated way. They suffered a loss in their ability to think creatively. This might explain why they did not decide to abandon the approach.

- 2.3.7.19 The unrest in the crew at this stage of the approach is further indicated by the Unidentified crew member finding it necessary to ask: 'We will be landing, will we not?' and, four seconds later, by the Co-pilot saying: '300° so far! Is it OK?' and at 08:21:47 hrs by asking: 'How are we approaching? Is it correct or not?' (The 300° mentioned by both the PiC and the co-pilot corresponds well with the magnetic heading recorded by the FDR.)
- 2.3.7.20 Δ 18 The Boards again find it necessary to stress that a crew being uncertain of the accurate position on final approach, especially in mountainous terrain, must climb to a safe altitude according to the missed approach procedure before trying to solve a problem. The Boards also urge the airline to review its procedures for abandoning an approach, bearing in mind the ample danger signals presented in this accident.
- 2.3.7.21 Again, at 08:21:55 hrs, there was another order by an Unidentified crew member to correct to the right: 'To the right here', but the correction was not carried out. However, 10 seconds later, an Unidentified crew member ordered: 'To the left'. A few seconds later the magnetic heading started to change as the aircraft was turned from 300° to the final heading of 291°, which was maintained the last five seconds before impact.
- 2.3.7.22 At this stage of the flight, the aircraft was approaching the extended centerline of runway 28. With the assumption that the GPS was programmed with inbound course 283° as indicated by the circumstantial evidence, the reason to correct to the right was no longer present and the correction was reversed to a left turn. It is therefore the opinion of the Boards that the crew crosschecked with the GPS and saw the aircraft mark close enough to the centerline to start the intercept to the left and finally get established on course.
- 2.3.7.23 During the last 20 seconds or so of flight, the aircraft entered an area of turbulence judging by the changes in the co-pilot's and the autopilot's steering. The co-pilot responded to the jerking flying very actively and managed to keep the roll within 10° together with an uninterrupted increase in pitch angle from about -4° to about +4°, right up to impact at 08:23:23 hrs. Half a minute before impact the co-pilot asked for the landing gear and a voice, most likely the PiC, gave permission to extend the landing gear. This corresponds very well with the fact that the landing gears were in transit on impact.
- 2.3.7.24 As recorded by the FDR the GPWS was activated about 9 seconds before impact, probably because the aircraft was in mountainous terrain, closer than 400 m to the ground and with a closure rate to the terrain above 5 m/s. Because the intermittent sounding of the warning horn was not recorded by the CVR, the Boards conclude that the horn for some reason was unserviceable. However, because the FDR has

recorded an increase in pitch, an almost immediate movement of the three throttle control levers, an increase in the percentage of the LP rotor speed and the rate of fuel flow for all engines, the Boards conclude that the red light annunciator in front of each pilot was working. On impact, the engines were not yet working at full power, but then the throttle control levers were not yet fully forward according to the FDR registration of this parameter.

- 2.3.7.25 Six seconds before impact, the CVR recorded the radio altimeter warning again for the last time. The two pilots had at this time reset their altimeters to 70 m (co-pilot) and 260 m (PiC) which meant that the right radio altimeter triggered the warning. Even though the GPWS horn was not functioning, there was nevertheless an aural warning, which verified and reinforced the GPWS visual warning, clearly indicating that they were getting dangerously close to the underlying terrain.
- 2.3.7.26 Δ 11 It is the opinion of the Boards that a reaction to a GPWS should be as quick and decisive as the handling and performance of the particular aircraft type allows. When evaluating the performance of a crew, one must allow for at least a couple of seconds in reaction time. In this case, it was to the crew's disadvantage that the aural warning of the GPWS did not work. Expecting both a visual and an aural warning at the same time and only getting one of them, might have initiated an evaluation of the situation which could explain the somewhat slow throttle control lever movement and pull-up of the aircraft. When the crew three seconds later got an aural warning, it was not connected to the GPWS, but belonged to a warning system that had already been triggered five times, when the crew knew the aircraft was maintaining a safe altitude. This fact did not support a decision to act with urgency.
- The fact that the bugs on the radio altimeters had been reset to 70 m and 260m respectively, altitudes expected to be reached some kilometers ahead, could also have had an influence. The Boards are of the opinion that the FSF ALAR Task Force's conclusion that proper use of the radio altimeter is an effective tool to prevent approach and landing accidents should be seriously considered, together with the procedures regarding the GPWS.
- 2.3.7.27 Evaluating the final seconds of flight and allowing for a couple of seconds reaction time, it is not likely that the crew, applying full power and maximum pitch-up, would have made the aircraft clear the mountain. The remaining seconds to impact would probably not have been enough time to change the aircraft flight path adequately.
- 2.3.8 Although unable to carry out a technical examination of the GPS, the Boards are of the opinion that circumstantial evidence points to the GPS most probably being reset with inbound course 283° in accordance with the imposed rule. Due to the demonstrated accuracy of the GPS system, the crew put too much emphasis on the GPS indications to the detriment of those on the HSI, and disregarded the RMI bearing to LON (which was correct on impact).

2.3.9 The Boards would point to the eight conclusions of the FSF ALAR Task Force, reproducing them here:

- No. 1: Establishing and adhering to adequate Standard Operating Procedures (SOPs) and flight-crew decision-making processes improved approach-and-landing safety.
- No. 2: Failure to recognize the need for and to execute a missed approach when appropriate is a major cause of Approach-and-Landing Accidents (ALAs).
- No. 3: Unstabilized and rushed approaches contribute to ALAs.
- No. 4: Improving communication and mutual understanding between air traffic control (ATC) services and flight crews of each other's operational environments will improve approach-and-landing safety.
- No. 5: The risk of ALAs is higher in operations conducted in low light and poor visibility, on wet or otherwise contaminated runways, and with the presence of optical or physiological illusions.
- No. 6: Using the radio altimeter (RA) as an effective tool will help prevent ALAs.
- No. 7: Collection and analysis of in-flight parameters (e.g. flight operational quality assurance [FOQA] programs) identify performance trends that can be used to improve approach-and-landing safety.
- No. 8: Global sharing of aviation information decreases the risk of ALAs.

The Boards find conclusions nos. 1, 2, 3, 4, and 6 to be particularly pertinent to this accident.

2.3.10 The crew of the Dornier 228 demonstrated the fact that the FMS gave flyable signals on the back beam of the ILS to runway 10 to the Boards. The same check made by the Flight Inspection Aircraft showed that that the FMS did not give reasonable steering information at all. As there are obvious differences between the aircraft types and the Dornier crew received useful steering information from their system, the Boards recommend that the NCAA review the policy, having all the ILS/LLZ at an airport operational simultaneously.

2.3.11 Due to the fact that poor quality CVR recordings hamper investigations from time to time and emphasizing the flight safety importance of such recordings, the Boards are of the opinion that a procedure for checking the quality of CVR recordings at set intervals should be a requirement.

3 CONCLUSIONS

3.1 Introduction

To illustrate the most likely classification of human errors that had an influence on the chain of events leading to the accident, the taxonomy of James Reason, professor of psychology at the University of Manchester (England), has been used to mark the different findings: Lapse = L; Slip = S; Rule-based mistake = R; Knowledge-based mistake = K; and Unintended exceptional violation = V. A lapse is an error of omission, in which an item previously known is forgotten. Lapses are unintended and are often caused by inattention or inadequate association at the time the item was learned. A slip is an error of commission in which the action does not proceed as planned. Slips are unintended and often are caused by inattention at the time of action. A ruled-based mistake is an error of commission in accordance with a rule that is inappropriate for the situation. A knowledge-based mistake arises inter alia from incomplete or incorrect knowledge. It is an error of commission in which the action proceeds as planned, but the plan is inappropriate for the situation. An unintended exceptional violation is a singular violation occurring in a particular set of circumstances.

3.2 Findings

3.2.1 Aircraft

- a. The aircraft was airworthy.
- b. The FDR shows that the aircraft could have been operated normally by the crew during the approach to Svalbard Airport Longyear.
- c. The aircraft's mass and the position of its center of gravity were within the permitted limits both at take off in Moscow and at the time of the accident.
- d. The recording of the open microphones in the cockpit has a very unfavourable signal-to-noise ratio, making the deciphering of the intra cockpit conversation extremely difficult. Finally, 80 - 90% of the conversation was interpreted. The remaining 10 - 15% of the communication does not contain any conversations of any length, just short remarks.
- e. The FDR parameters recorded were of satisfactory quality, except for channel no. 18, which recorded the position of the right elevator and channel no. 12, which recorded gyro-magnetic heading. This was caused by a functional error in the BR-40 element of the recording channel. The function of the compass systems was not affected.

- f. The last radio altimeter warning signal recorded by the FDR started when the aircraft was about 530 m from the impact point and about 270 m above the terrain. The signal was triggered by the right radio altimeter. The other five warning signals were recorded when the aircraft was at safe altitudes less than 750 m above terrain details.
- g. The GPS mounted on the central instrument panel, had been torn loose on impact and was observed lying by itself on the ground before the registration of parts started. Somebody removed it from the site and it has not since been returned to the AAIB/N.
- h. The most probable frequency set on the two PUR SD-75 units was 109.5 MHz equal to the frequency of the localizer LA for approach to runway 28 at Svalbard Airport Longyear.
- i. The mode selector Kurs MP-70 was in the ILS operation mode.
- j. ADF no.1 was not in use during the approach. ADF no. 2 frequency selectors indicated 425 kHz, and 326 kHz Advent NDB. The toggle switch was in position 1, indicating that 425 kHz was in use. The damage to the frequency selector indicated that the figures could have changed during impact. Further examination made it possible to conclude that the RMI needles no. 2 were pointing to LON at the time of impact, which implies that the figures had changed from 350 kHz.
- k. A copy of the GPS database installed in RA 85621 contained correct information concerning ENSB, Svalbard Airport Longyear and it stated 'No approach for this airport in the database.' The GPS installed in RA 85621 required that the operator typed ENSB and set the landing course in degrees to have a course line displayed in OBS mode.
- l. There were enough satellites available to provide good cuts for the GPS receiver on board RA 85621. The satellite geometry was normal and the GPS data show nothing unusual for the period VKO 2801 flew the approach to Svalbard Airport Longyear. The tail did not obstruct any of the available satellites during the approach.
- m. The two compass systems in gyro-magnetic mode indicated correct headings to the crew.
- n. The crew did not receive erroneous distance information.
- o. The GPWS was activated about 9 seconds before impact. The warning horn was for some reason unserviceable, but the red light annunciators were working.

3.2.2 Ground-based navigational equipment

- a. The reason for the $\pm 10^\circ$ user-limitation on the LLZ 28 is less than the required signal strength at 25 NM. The radiation from the 6-element antenna is not limited. It radiates normally.
- b. The NCAA's policy is to have all the navigational aids operational at all times to avoid delays when the situations demand their use.
- c. A horizontal misplacement of the localizer signal of practical importance, due to atmospheric refraction, ground reflections or a combination of the two, is not likely.
- d. The Eiscat radar at Svalbard was not in operation on 29 august 1996. The antenna was in stowed position with lock pins in place and the site was unmanned and securely closed. Interference with the LLZ 28 was therefore not possible.
- e. The Dornier 228 crew demonstrated that the FMS on this aircraft gave reasonable steering information on the LLZ back beam to runway 28, frequency set at 110.3 MHz.
- f. The Dornier 228 crew who were recalled to participate in the search operation for VKO 2801 used the LLZ 28 to keep track of their position without registering any anomalies.
- g. None of the flight inspections of the LLZ 28 have revealed any anomalies within the $\pm 10^\circ$ sector authorized for use.
- h. The checks and tests made on the approach navigational ground systems all showed normal results.
- i. The test flight carried out with a TU-154M demonstrated that a similar aircraft to RA 85621 could fly the LLZ 28 approach to the Svalbard Airport Longyear accurately. No anomalies were detected within the $\pm 10^\circ$ sector.
- j. The test flight demonstrated that the VDF service gave an accurate check of the localizer centerline. The two ADFs onboard tuned to LON and ADV gave good backup indications of the localizer centerline, except when the test aircraft came fairly close to the antennas.

3.2.3 Flight conditions

- a. The actual weather conditions satisfied the PIC minimum requirements to carry out the approach to Svalbard Airport Longyear.

- b. The approach was carried out in IMC.
- c. The magnetic field intensity recorded during the time VKO 2801 approached Svalbard Airport Longyear was characterized as disturbed. However, the variations were not of a magnitude considered to cause any significant disturbances to compass systems in gyro-magnetic mode.

3.2.4 The crew

- a. The crew members were properly licensed. Working hours and rest periods prior to the accident were within the limits prescribed by regulations.
- b. The post mortems carried out on the crew revealed no anomalies and no traces of chemical substances.
- c. Landing on runway 10 was within the aircraft type performance limits.
- d. The crew did not attempt to carry out a back beam approach to runway 28.
- e. The navigator controlled the aircraft laterally by the Autopilot Turn knob most of the approach, while the co-pilot controlled the vertical navigation.
- f. The demonstrated dynamics of the general psycho-emotional state of the crew was not enough to initiate inferior performance by the crew members making them commit mistakes in their work.
- g. The vertical navigation of the aircraft was carried out correctly except for the fact that the descent was made off the localizer centerline to the right.
- h. There were no calls for checklists after 'Before descent' checklist. (L)
- i. The crew did not check the identity of the tuned ground navigation aids. (S)
- j. The radio altimeter warning signal was triggered five times when the flight was at a safe altitude. When the radio altimeter warning sounded for the sixth time, together with the visual warning of the GPWS, the crew probably became unsure as to whether the situation was urgent or not, leading to a somewhat slower than ideal reaction to the GPWS. However, the aircraft was at this time probably too close to the terrain for the crew to change the flight path sufficiently to avoid the mountain. (S)
- k. The crew did not make full use of the ADFs onboard, tuning ADV and LON on separate receivers. (L)

3.2.5 The Airline

- a. It is a standard operating procedure that crews from Vnukovo Airlines study

the different approach charts and have to fly these approaches in the simulator when preparing for flights to airports in mountainous terrain.

- b. The Norwegian AIP was not available at Vnukovo Airlines, preventing the possibility of obtaining secondary information concerning Svalbard Airport Longyear. (K)
- c. The airline relied upon the flight information furnished by Jeppesen & Co. GmbH and the GPS database from Allied Signal General Aviation Avionics/Jeppesen Sanderson to contain all the necessary and required items in order to plan and carry out safe flights. (K)
- d. The flight deck crew did not know of the possibility of checking their own navigation by the VDF service offered at Svalbard Airport Longyear. (K)

3.2.6

The Authorities

- a. The AFIS officers at Svalbard Airport Longyear had never been requested by Russian crews not stationed at Svalbard to provide VDF service. (K)
- b. The last VDF reading the AFIS officer got while communicating with VKO 2801 indicated that the flight had not yet reached the approach centerline. The CVR/ FDR information supports the observation of the AFIS officer.
- c. The information on Svalbard Airport Longyear contained in the Norwegian AIP was correct.
- d. Even though it is the responsibility of any airline or PiC to evaluate if the available approach aids at a destination are sufficient for a safe flight, taking into consideration the particular aircraft's equipment and performance, together with the flight crew's experience and expected weather conditions, radar service represents a valuable safety barrier for checking deviations from established tracks.
- e. The phrase 'Approved,' uttered by the AFIS officer without adding the approving authority could possibly have given the crew of VKO 2801 an incorrect conception of his status.

3.2.7

Additional factors

- a. To avoid congested approach charts, Jeppesen & Co. GmbH's policy is to reduce information considered to be of secondary importance.
- b. A user-oriented questionnaire of the LLZ 28 approach at Svalbard Airport Longyear received full cooperation from 140 pilots representing 740 approaches, of which none had experienced any anomalies.

- c. In an unprepared and stressed situation, the user limitation on the LLZ 28 could be overlooked.
- d. The FSF ALAR Task Force's conclusions 1, 2, 3, 4, and 6, concerning Standard Operating Procedures and decision-making processes, discontinuing unstabilized and rushed approaches, communication between air traffic control and flight crews, and active use of the radio altimeter to avoid controlled flight into terrain were particularly pertinent to this accident.

3.2.8

Significant findings

- a. There is no Russian procedure for offset localizer approaches modifying the required rule to set the landing course on the HSI. (R)
- b. The course selected on both HSIs was 283° even though the approach course is 300°. This setting does not affect the indication of the CDI. However, the CDI was pointing to 283° on the dial, which is 17° to the left of the approach course, giving a visual impression of wind drift to the left and therefore giving a possible reason for a heading correction to the right. (R)
- c. The navigator in a stressed and overloaded working situation most probably followed the rule setting the landing course 283° on the GPS in OBS mode instead of the approach course 300°. (R)
- d. The crew was not fully aware of the status of an AFIS officer in comparison with the authority of a Russian air traffic controller with the result that the crew accepted safety information from the AFIS officer as orders. (K)
- e. The crew had limited knowledge of the English language with the consequence that they had problems communicating their intentions to the AFIS officer. (K)
- f. The navigator was overloaded with tasks leaving little time for rechecking his work, thereby setting the scene for making mistakes. (S)
- g. The pilots did not monitor the work of the navigator sufficiently. (L)
- h. Leaving the communication with AFIS to the navigator during the approach was not according to the normative documents. (K)
- i. Due to the workload of the navigator, the decision of the co-pilot to transfer the responsibility of controlling the aircraft laterally to him, was inappropriate. (K)
- j. The crew resource management of the PiC was not satisfactory. (K)

- k. When the crew had made the decision to carry out the approach to runway 28, a new approach briefing was not accomplished. (V)
- l. The crew made the proper correction for the wind drift, but did not try to intercept the outbound track from ADV with the consequence that they overshot the approach centerline turning inbound. (K)
- m. Seemingly confusing indications on the HSIs in the base turn caused the crew to become uncertain of the aircraft position in relation to the LLZ 28 centerline. In this situation, the crew showed a lack of situational awareness. (K)
- n. The two pilots did not have the approach chart in front of them at all times during the approach making it difficult for them to maintain situational awareness. (R)
- o. The crew did not know of the possibility to check the position of the aircraft in relation to the localizer centerline by the VDF service available. (K)
- p. On final approach the crew probably put too much emphasis on the indications displayed on the GPS. (K)
- q. The crew started descent in a mountainous area without firm and positive control of the lateral navigation demonstrated by the disagreement within the crew as to whether to correct to the left or right. (V)
- r. In spite of the uncertainty within the crew as to whether they were approaching correctly or not, they continued instead of abandoning the approach and climbing to a safe altitude to solve the problem. (V)

4 SAFETY RECOMMENDATIONS

4.1 Introduction

On 19 September 1996, the AAIB/N made a preliminary recommendation to the NCAA concerning the VDF service available at Svalbard Airport Longyear not being printed on Jeppesen approach charts. Further investigation has revealed that Jeppesen consider this service as secondary information, which is left out to resolve the flight safety problem of congested approach charts.

The Interstate Aviation Committee and the Norwegian Aircraft Accident Investigation Board recommend the following:

- 4.1.1 The RFCAA reassesses the rule of setting the landing course instead of the localizer course on the HSI for ILS/ LLZ approaches in relation to offset approaches.
(Recommendation no. 21/99)
- 4.1.2 The RFCAA assesses the inclusion of a mandatory procedure in NPP GA-85 to request VDF bearings to check own navigation on approaches especially to airports in mountainous terrain (and then a revision of the Federal Aviation Regulations).
(Recommendation no. 22/99)
- 4.1.3 The RFCAA reassesses the crew operation guidelines for TU-154s concerning the tasks ascribed to the navigator, starting with the descent from cruising level.
(Recommendation no. 23/99)
- 4.1.4 The RFCAA assesses the necessity to check the quality of the CVR third channel (open microphone) on the fleet of TU-154s.
(Recommendation no. 24/99)
- 4.1.5 The RFCAA assesses if the English language programme for air traffic controllers could be beneficial for air crews as well.
(Recommendation no. 25/99)
- 4.1.6 Vnukovo Airlines Operations reassesses the present Crew Resource Management on approaches related to the norms in force and assesses if a CRM program could be beneficial to flight crews.
(Recommendation no. 26/99)
- 4.1.7 Vnukovo Airlines Operations assesses the present policy of collecting flight safety information concerning foreign airspace and destination airports.
(Recommendation no. 27/99)
- 4.1.8 Vnukovo Airlines Operations assesses the inclusion of situations with uncertain navigational indications, especially ILS/ LLZ indications, into air crew training to improve situational awareness.
(Recommendation no. 28/99)
- 4.1.9 Vnukovo Airlines Operations assesses whether the present procedure of starting a turn with a linear lead should be extended to include interceptions to ensure that the flight crews regain the track if they overshoot.
(Recommendation no. 29 /99)

- 4.1.10 The RFCAA, Tupolev Design Bureau and Vnukovo Airlines Operations reassesses the present procedure for the use of the radio altimeter to avoid nuisance warnings and to protect against controlled flight into terrain.
(Recommendation no. 30/99)
- 4.1.11 Vnukovo Airlines Operations assesses whether the pilots should have their own approach charts in front of them during approach to improve their situational awareness.
(Recommendation no. 31/99)
- 4.1.12 Vnukovo Airlines Operations assesses whether it is necessary to reinforce an instruction to the flight crews to discontinue an approach if any crew member becomes uncertain of the navigation, and climb to a safe altitude before attempting to solve the problem.
(Recommendation no. 32/99)
- 4.1.13 The NCAA assesses the current policy of giving priority to radar installations at airports in mountainous areas.
(Recommendation no. 33/99)
- 4.1.14 The NCAA reassesses the approach procedure to runway 28 at Svalbard Airport Longyear with respect to establishing the base turn and the holding pattern on the other side of the centerline.
(Recommendation no. 34/99)
- 4.1.15 The NCAA assesses whether there is a need for English language and phraseology recurrent training for AFIS officers.
(Recommendation no. 35/99)
- 4.1.16 The NCAA and Jeppesen & Co. GmbH assess whether the sectors authorized for use on the approaches to Svalbard Airport Longyear should be more conspicuous on the charts (ie. limiting bearings).
(Recommendation no. 36/99)
- 4.1.17 The NCAA assesses the current policy of having all ground-based navigational aids running at all times with reference to the fact that the FMS of the Dornier 228 gave reasonable steering information on the ILS back beam.
(Recommendation no. 37/99)
- 4.1.18 Although the Boards recognize the necessity of limiting the amount of information presented to flight crews on the approach charts, the Board recommends that Jeppesen & Co. GmbH evaluates their policy on secondary information and

considers whether this information may be presented differently than on the approach charts. (ref. SAS solution - separate briefing sheets.)
(Recommendation no. 38/99)

- 4.1.19 The RFCAA and NCAA assess a requirement to check the quality of CVR recordings at set intervals.
(Recommendation no. 39/99)

5 APPENDICES

1. Jeppesen approach chart Svalbard, Norway 11-2
2. Combined ATS recording and CVR readout interpretation
3. Sequentially Timed Events Plotting (STEP)
4. FDR readout
5. Contour map, with CVR statements depicted
6. FSF paper on English language training
7. Chart of Svalbard, Longyear area
8. Abbreviations

AIRCRAFT ACCIDENT INVESTIGATION BOARD, NORWAY (AAIB/N)

Kjeller, 2 November 1999

Transcript of CVR Tu-154 No. 85621 and Longyear AFIS sound recordings 29th of August 1996.

CVR communication was recorded/presented originally from time 07:48:35. The revised transcript (From the Speech Technologies Centre (St. Petersburg)) started at time 07:59:12. These two times and all following times are now adjusted in relation to the exact UTC time the accident took place. This time, 08:22:23, was recorded by a seismographic station. The start of the CVR is therefore adjusted to 07:47:23, and the revised transcript starts at 07:58:00. The AFIS recordings were adjusted in a similar way. (Local time was + 2 hours from UTC.)

PiC = commander, Cop = second pilot (the pilot flying the aircraft), Nav = navigator; F/e = Flight engineer; U = unidentified crew member, AFIS = Aerodrome flight information service, Traff. = Other R/T traffic, () = 'sounds like' and (ind.) = indistinct.

Bold letters indicate radio communication between the aircraft and AFIS.

07:47:23	U	So, the 'radar' is surrounded by mountains.
		<i>Comment: There is no radar installed at ENSB. Probably ment localizer.</i>
	Cop	Didn't you fly here at night?
	Cop	It's OK then. Everything is covered by clouds.
49:20	PiC	My first flight here was at night.
	Cop	At what time shall we land?
	PiC	Between 8.10 and 8.20.
	PiC	Wind (ind.) (?15 metres).
	PiC	(ind.) (?up to second outer)... ...(ind.).
49:58	U	Flaps 15? (ind.).
50:01	Cop	Let's extend the spoilers! (ind.).
50:04	U	Reduce the speed somehow (?which).

07:50:08 U 140.

50:31 Cop But, during the summer what is the maximum temperature here?

PiC It's 30 degrees in summer here.

51:18 Cop Well, that's OK then. Shall we descend?

51:30 PiC But, you have not estimated the distance yet, have you?

Nav 22! Just hold on!

U (ind.) up to 47.

51:50 PiC Let's take a briefing before landing!
Landing - at Spitzbergen, alternate - Murmansk. Left pilot flying, communications - from the right. Landing course - 103°. Missed approach: Straight, then climbing turn LEFT to (ind.). Landing approach to distance (16) to maintain until gaining the glide path. Estimated landing weight - 78 tons. Flaps - 45. Speed - 275.

52:49 Cop I'll adjust the speed for you, while you carry out the approach.

PiC Pressure 751, check against the check list, report ready!

53:01 F/e Understood. I'm, ready!

53:02 U Everything is checked (ind.).

53:28 PiC 751. Ready! Check against Before descent check list.

PiC I have been acquainted.

Cop Request! It is time to descend.

54:12 Nav **Bodø control estimate descent.**

54:25 Nav **Bodø control, 2801 estimate descent.**

54:51 Nav **Longyear information, Vnukovo 2801. Good morning.**

55:10 Nav **Longyear information, VKO 2801. Good morning.**

07:55:17 AFIS Victor Kilo Oscar 2801 Longyear, could you change to frequency 119.85, 119.85, over.

55:24 Nav 119.85, thank you.

55:31 Nav Longyear information, VKO 2801. Good morning.

55:38 AFIS VKO 2801 Longyear information, go ahead.

55:40 Nav 2801 ETA ENSB 08.15. Estimated descent.

55:54 AFIS VKO 2801, you are broken, readability is poor, say again.

55:59 Nav Estimated descent from level 350 to level 60.

56:08 AFIS VKO 2801, that is approved, we have no conflicting traffic, TL 65, QNH below is 1005.

56:19 Nav 2801, roger. Leaving level 350 for level 60. QNH 1005. Estimated approach runway 10.

56:38 AFIS VKO 2801 Longyear roger. Are you making an approach via INDIA - - - INDIA-SIERRA-DELTA? over.

56:44 Nav INDIA-INDIA-SIERRA-DELTA, 01.

57:51 AFIS VKO 2801 Longyear roger, runway 28 in use. We have wind from 230/16. Weather is: We have visibility more than 10 kilometers in showers of rain, few at 1500 feet and scattered at 2000 and broken at 4000. Temp is 5, dewpoint 0, QNH 1005.

57:26 Nav 2801 roger, - - - Making a descent to level 60, QNH 1005. Reach altitude 4000 feet.

57:43 AFIS VKO 2801 Longyear roger, give me a call when you are passing INDIA-SIERRA-DELTA.

57:50 Nav I proceed to INDIA-SIERRA-DELTA, 2801.

57:56 Cop There is an altitude margin.

57:59 AFIS Call passing INDIA-SIERRA-DELTA, and also now change frequency to 118.1.

07:58:04 Nav 118.1, good day.

58:15 Nav Longyear information 2801, continue down to 60, proceed to INDIA-SIERRA-DELTA.

58:26 AFIS VKO 2801 Longyear roger.

58:44 AFIS VKO 2801. Can I have your estimate for INDIA-SIERRA-DELTA?

58:50 Nav Estimating INDIA-SIERRA-DELTA at five-niner.

58:58 AFIS Thank you.

59:01 U (ind.).

59:13 AFIS VKO 2801 Longyear, roger.

59:19 Nav They're always having problems.

59:22 Cop Passing over.

59:41 AFIS VKO 2801 Longyear, confirm you will make an approach for runway 28, via ALFA-DELTA-VICTOR?

59:50 Nav For runway 28, 2801 understand you?

59:58 Nav - - - to LIMA - ALFA?

08:00:07 AFIS VKO 2801 Longyear, after passing ISFJORD, suggest you are heading for ALFA-DELTA-VICTOR at 5000 feet?

00:17 Nav 2801 Continue down to 4000 - - - 4500 feet, QNH 1005.

00:29 Cop And what's this they have here?

00:30 PiC There is a mast here.

00:34 Cop Mast.

00:36 U (?It should stay).

00:40 U There is some more traffic.

00:41 Cop Here (somebody is flying) (such high hills!).

08:00:44 PiC Keep the course.

00:48 Nav (?So), Let's turn to the right!

00:52 U (ind.).

00:55 Traff. **Longyear, LMQ.**
AFIS **LMQ, Longyear.**
Traff. **Climb to 6 500 feet, est. Ny-Ålesund at 17.**
AFIS **OK, roger that -- contact Ny-Ålesund -- and -- so long.**
Traff. **So long!**

01:23 PiC I've told you, that it should be (to the right - - - (ind.).

02:12 Cop Is the 'radar' an unusual one?
Comment: There is no radar installed at ENSB. Probably ment localizer.

02:14 U No.

02:17 PiC No, it's simply - - -.

02:40 U Yeah, that's what I call an approach!

02:44 U It is!

03:08 Traff. **Longyear Information, CDS 156 passing abeam BRAVO 600 feet.**
AFIS **CDS 156, Longyear information, roger. Check traffic is Dornier, taking off Runway 28 this time for a right circuit for a landing at 28 again, for touch and go.**
Traff. **Roger, CDS 156.**
AFIS **Coast guard 21, airborne time 03, and did you check the traffic?**

04:02 Nav (? We've) reached - - -

08:04:28 Nav **Longyear information, VKO 2801 - - -.**

04:30 AFIS **Aircraft calling Longyear, say again.**

04:40 Nav **Longyear information 2801 request runway in use for landing to runway 1 --- 10.**

04:56 AFIS **VKO 2801 Longyear, runway in use is 28.**

04:59 Nav **Roger, 28.**

05:52 F/e I understand the approach will be made in clouds. (Icing).

07:30 Traff. **Climbing to 80, heading Vangbergøya.**

AFIS **Coast Guard 21, Longyear checked.**

07:40 Traff. **CDS 156, on final (ind.).**

AFIS **CDS 156, Longyear (ind.) Runway free.**

Traff. **Yes.**

08:34 Traff. **Longyear, LN-OPP.**

AFIS **LPP, Longyear.**

Traff. **LPP airborne at Isfjord at 06, 1 POB returning.**

09:03 Nav We are 'diving' into the 'zone'!

09:11 Cop We have taken in Advent.

09:13 Nav Seven thousand? It should be earlier!

09:15 U Go after the pike (Arrow head).

09:19 Nav The pressure is 751 mm.

09:20 AFIS **LPP, Longyear roger. I'll give you a weather report in a minute.**

09:20 PiC 5 minutes and we'll descend.

09:28 U Six thousand and (?three hundred).

08:09:31 PiC New altitude, we're maintaining 5 000.

09:37 PiC Give me the approach chart!

09:45 PiC The approach chart!

10:24 Cop What about the speed?

10:28 Cop Shall we extend the landing gears?

10:29 U Landing gears.

10:32 PiC Keep the course!

10:36 Cop We have reached 1500 m.

10:49 Cop We'll land by the standard procedure.

10:53 Nav Standard.

11:06 U Forty-three degrees.

11:13 U (ind.).

12:08 U Forty-three degrees.

12:12 AFIS **LPP, Longyear, weather at Longyear, wind from 210/17, visibility to the west is about 6-7 km due to rain and - - - otherwise more than 10. We have few at 1 000 and broken at 2 000, temp. is 6, QNH 1006.**

12:40 Cop What should I keep?

12:46 U Meanwhile we should keep 500!

12:58 Cop Switching on that one!

13:05 Traff. **Coast guard 21, climbing for niner zero.**

AFIS **Coast guard 21, Longyear, say again.**

Traff. **We are climbing for niner zero.**

AFIS **Coast guard 21, Longyear roger.**

13:44 Nav We will land by Jeppesen!

08:13:46 **Radio altimeter warning, duration 6 seconds.**

14:00 PiC Check-list!

14:08 U (? I'm reading - - -) (ind.).

14:13 U We will go (to the holding area) by the course - - -.

14:54 AFIS **VKO 2801 Longyear information, what is your position and altitude?**

14:58 Nav **Maintaining 5000 feet, QNH 1006, approaching Lima-Alfa - - - inbound - - - outbound.**

15:11 AFIS **VKO 2801 Longyear roger, give me a call passing ALFA-DELTA-VICTOR or Advent outbound.**

15:17 Nav **I call you back over Lima Alfa, 2801.**

15:32 Nav **2801 passing now over NDB Lima Alfa, altitude 5000 feet on 1006, turning right, heading 15-155.**

15:53 AFIS **VKO 2801 Longyear, say again.**

15:57 Nav **2801 Passing now NDB Lima-Alfa - altitude 5000 feet, turning right, heading 155.**

16:08 AFIS **VKO 2801 roger, and give me a report passing ADV, or abeam ADV inbound.**

16:19 Nav **01, call you back over inbound, abeam Alfa-Delta-Victor, 2801.**

16:30 AFIS **Yeh, give me a call passing abeam ADV.**

16:33 Nav **ALFA-DELTA-VICTOR.**

16:43 AFIS **Call me passing abeam Advent beacon.**

16:50 Nav 150.

16:52 PiC By parallel - - - (ind.).

08:16:55 Nav No, seven miles here.

16:56 Nav I'll adjust it.

17:05 Cop Where are we ---? --- (ind.).

17:06 Nav Meanwhile, keep it like that!

17:08 PiC Did you notice the place?

17:09 Nav Abeam the turning point.

17:14 PiC A corrective turn will be (?necessary).

17:16 U We're approaching.

17:21 PiC Now we will be (?the flaps)... (ind.)

17:40 AFIS **VKO 2801 give me a call eight miles inbound.**

17:43 *Radio altimeter warning, duration 6 seconds.*

17:44 Nav **Call you back ten miles inbound, 2801.**

17:55 AFIS **VKO 2801, give me a call eight miles inbound.**

17:57 F/e Eight miles (In the English language).

17:57 Nav **Ah - abeam eight miles 2801 inbound ---.**

17:59 AFIS **Correct.**

18:05 U Four marks (ind.).

18:08 PiC But here it's already three.

18:14 U There's no need to --- here!

18:16 *Radio altimeter warning, duration 2 seconds.*

18:17 U --- to descend.

18:19 Cop The flag disappeared on my instrument!

18:21 *Radio altimeter warning, duration 6 seconds.*

08:18:25 AFIS **LPP, Longyear roger, we have a traffic inbound Tupolev, suppose he will be passing 8 miles east in a few minutes.**

18:28 PiC I'm turning just a little bit to the left.

18:32 Cop Set it straight.

18:37 PiC 15.

18:39 PiC Borya, have we got it?

18:41 Traff. **LPP, roger.**

18:45 U Set it!

18:47 U How many?

18:50 U (?Switching off) (?Switching on).

18:51 U Switched off.

18:52 PiC What should I hold?

18:59 PiC OK, leave it!

19:03 U So, what might the recommendations be?

19:04 PiC So.

19:06 Cop Maybe we took the fourth (final turn) too early?

19:11 PiC Let's level out!

19:14 PiC No, (?it should be) to the right.

19:16 Nav Just we'll get it, just now!

19:18 Nav Is the mark (marker?) to the right?

19:19 Cop No, it is still staying.

19:19 PiC To the right!

19:20 PiC Let's turn to the right

19:21 ***Radio altimeter warning, duration 6 seconds***

08:19:21 PiC Give me the approach chart Borya.

19:22 Cop Should we descend here?

19:24 PiC We shall descend!

19:30 Cop Should we approach?

19:32 PiC Let's 'dive'!

19:34 PiC What (?course) did you keep (?now), (?what did you keep?).

19:36 Nav Three hundred degrees.

19:36 Traff. **LPP, now crossed centerline and we will stay east of shoreline.**

AFIS **PP, Longyear, say again.**

Traff. **We have crossed center line and will stay north and east of shoreline, landing on the apron.**

19:51 Nav But it's fourteen here!

19:52 PiC OK.

19:54 AFIS **LPP, sorry about that. Did not copy, could you say again?**

19:54 PiC So, fix it!

19:59 Nav Five metres.

20:03 Traff. **LPP, be landing on the apron.**

20:03 Nav So, I'll keep about 320°! OK?

20:04 AFIS **LPP, Longyear, roger. Wind is 230/17 and give me a call passing extended centerline.**

20:14 Traff. **LPP, will call you right downwind out of the apron.**

20:14 Cop Isn't that too little?

20:15 Nav It should be a corrective turn.

20:16 AFIS **PP, Longyear roger, thank you.**

08:20:17 PiC No! Turn to the left!

20:21 Nav It's thirteen. Let's descend!

20:24 Cop To the left!

20:24 Nav Three degrees and five minutes. We're on the glide path.

20:29 Cop We're on landing course now, correct?

20:33 PiC To get the landing course, make a slight correction to the left!

20:41 Nav Three hundred and thirteen. Let's descend!

20:44 Cop What about the flaps?

20:52 Cop 28?

20:57 U (?Keep)... (ind.) 5 metres.

20:58 Nav (ind.) 2 - 3 miles.

21:00 PiC You guide us, you guide us!

21:00 Nav We're flying by Jeppesen

21:02 Nav (ind.).

21:02 PiC Igor, set Advent for me.

21:05 U (ind.).

21:08 Nav Not now. Later on!

21:09 U Well, (? now) it's three hundred - - - meters (just now)

21:14 U No

21:15 Nav I've told you there is no need.

21:19 U To the right.

21:22 PiC What is our radial?

21:24 Nav Let's follow the approach chart to the end!

08:21:25 Traff. **LPP, landed 21.**

21:29 U So, - - - (ind.).

21:31 U We will be landing, will we not?

21:32 PiC Well, that is OK.

21:33 PiC 300°

21:35 Cop 300° so far! Is it OK?

21:36 Nav Flying through 1150. It's too high, we have to descend.

21:41 PiC We have to descend.

21:43 PiC So.

21:47 Cop How are we approaching? Is it correct or not?

21:49 Cop Landing gears?

21:51 U The landing gears may be extended.

21:55 U To the right here.

22:05 U To the left.

22:07 Cop So. How are we going for altitude?

22:09 Nav Three hundred, five metres. Descending!

22:13 Cop That's about five metres, is it not?

22:17 *Radio altimeter warning, duration 6 seconds.*

22:22 PiC Horizon!

22:23 Cop Mountains!!!

22:23 *Sound effect of impact with ground against background of radio altimeter warning signal.*

08:22:25 AFIS VKO 2801, weather is wind from 231/17, visibility still more than 10 in rain, we have few at 900 feet and broken at 2000.

22:58 AFIS VKO 2801 did you copy latest weather?

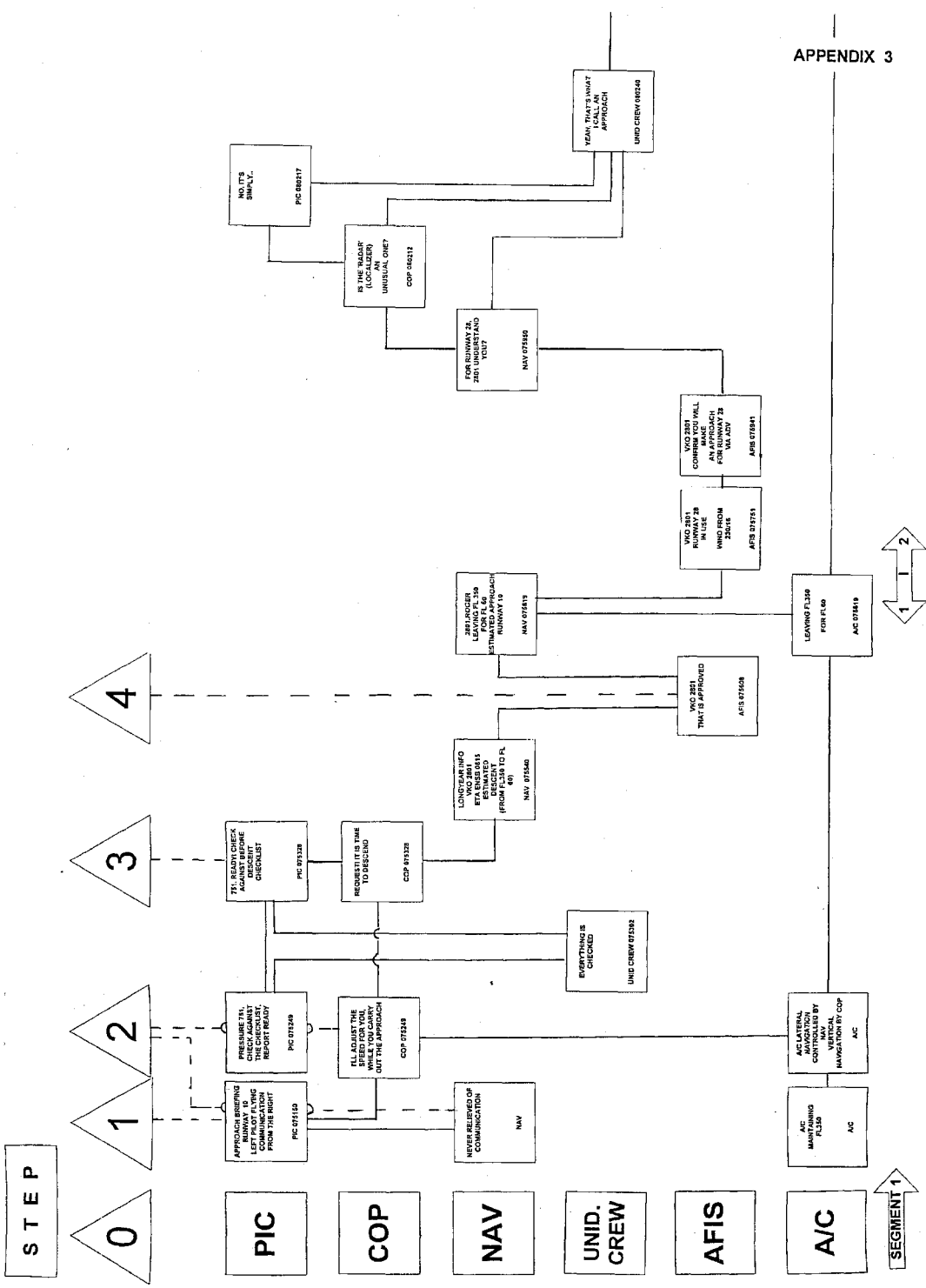

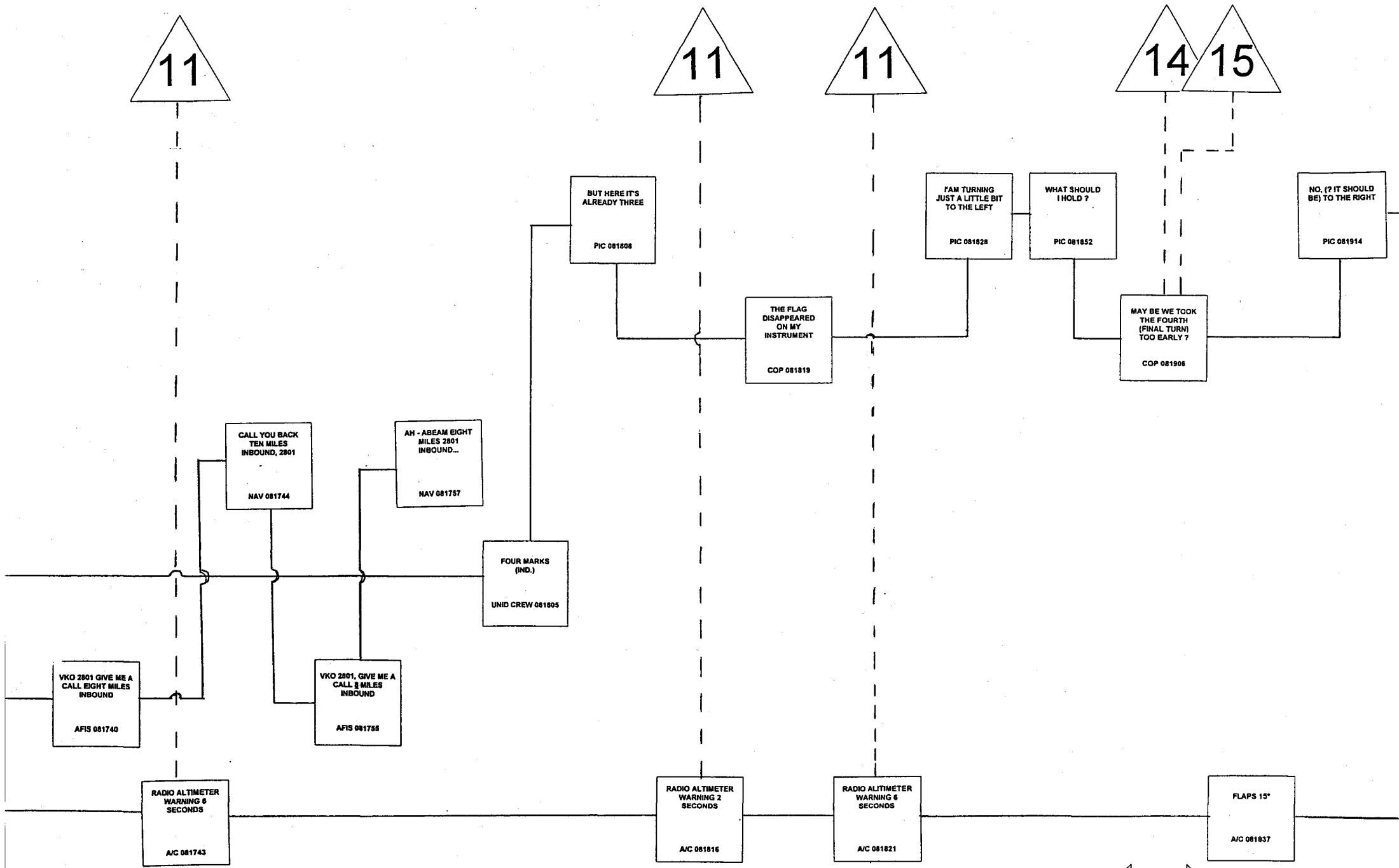

15

11

16

17

TO THE RIGHT !
LET'S TURN TO THE
RIGHT
PIC 081920

LET'S DIVE
PIC 081932

WHAT (7 COURSE)
DID YOU KEEP (7
NOW)
PIC 081934

NO! TURN TO THE
LEFT!
PIC 082017

NO, IT IS STILL
STAYING
COP 081919

IS THE MARK
(MARKER 7)
TO THE RIGHT?
NAV 081918

THREE HUNDRED
DEGREES
NAV 081936

BUT IT'S
FOURTEEN HERE!
NAV 081951

SO I'LL KEEP ABOUT
320° OK ?
NAV 082003

ISN'T THAT TOO
LITTLE ?
COP 082014

IT SHOULD BE A
CORRECTIVE TURN
NAV 082015

IT'S THIRTEEN
LET'S DESCEND!
NAV 082021

A/C ROLLING OUT
ON HEADING 291°
A/C 081916

A/C TURNING RIGHT
FOR HEADING 308°
A/C 081920

RADIO ALTIMETER
WARNING 6
SECONDS
A/C 081921

A/C MAINTAINING
HEADING 308°
A/C 081931

A/C LEAVING 1500M
(5000FT) ON FINAL
APPROACH
A/C 082021

17 18 19

20

18

18

TO GET THE LANDING COURSE, MAKE A SLIGHT CORRECTION TO THE LEFT!
PIC 082033

YOU GUIDE US, YOU GUIDE US!
PIC 032100

IGOR, SET ADVENT FOR ME
PIC 082102

WHAT IS OUR RADIAL?
PIC 082122

300°
PIC 082133

TO THE LEFT!
COP 082024

WE'RE ON LANDING COURSE NOW, CORRECT?
COP 082029

WHAT ABOUT THE FLAPS?
28?
COP 082044

WE'RE FLYING BY JEPPESEN
NAV 082100

NOT NOW, LATER ON!
NAV 082108

LET'S FOLLOW THE APPROACH CHART TO THE END!
NAV 082124

300° SO FAR! IS IT OK?
COP 082135

FLYING THROUGH 1150, IT'S TOO HIGH, WE HAVE TO DESCEND
NAV 082136

THREE DEGREES AND FIVE MINUTES, WE'RE ON THE GLIDE PATH
NAV 082024

TO THE RIGHT
UNID. CREW 082119

WE WILL BE LANDING, WILL WE NOT?
UNID. CREW 082131

A/C TURNING LEFT FOR HEADING 291°
A/C 082023

A/C HEADING 291°
A/C 082033

FLAPS 28°
A/C 082052

A/C IN A SLIGHT CORRECTIVE TURN TO THE RIGHT FOR HEADING 300°
A/C 082119

A/C MAINTAINING HEADING 300°
A/C 082134

18

11

HOW ARE WE APPROACHING?
IS IT CORRECT OR NOT?
COP 082147

SO, HOW ARE WE GOING FOR ALTITUDE?
COP 082207

HORIZON!
PIC 082222

MOUNTAINS!!!
COP 082223

THREE HUNDRED,
FIVE METERS,
DESCENDING!
NAV 082209

THE LANDING GEAR MAY BE EXTENDED
UNID CREW 082151

TO THE RIGHT HERE
UNID. CREW 082155

TO THE LEFT
UNID. CREW 082205

A/C DID NOT TURN
A/C 082155

A/C STARTING A SLIGHT CORRECTIVE TURN TO THE LEFT FOR HEADING 291°
A/C 082205

RADIO ALTIMETER WARNING 8 SECONDS
A/C 082217

SOUND OF IMPACT AND RADIO ALTIMETER WARNING SIGNAL
A/C 082223

5

Рис. 4 ПАРАМЕТРЫ ПОЛЕТА САМОЛЕТА ТУ-154М RA-85621 29.08.1996г. (предварительная обработка)



Рис. 2 ПАРАМЕТРЫ ПОЛЕТА САМОЛЕТА ТУ-154М RA-85621 29.08.1996г. (предварительная обработка)



Рис. 3 ПАРАМЕТРЫ ПОЛЕТА САМОЛЕТА ТУ-154Н RA-85621 29.08.1996г. (предварительная обработка)

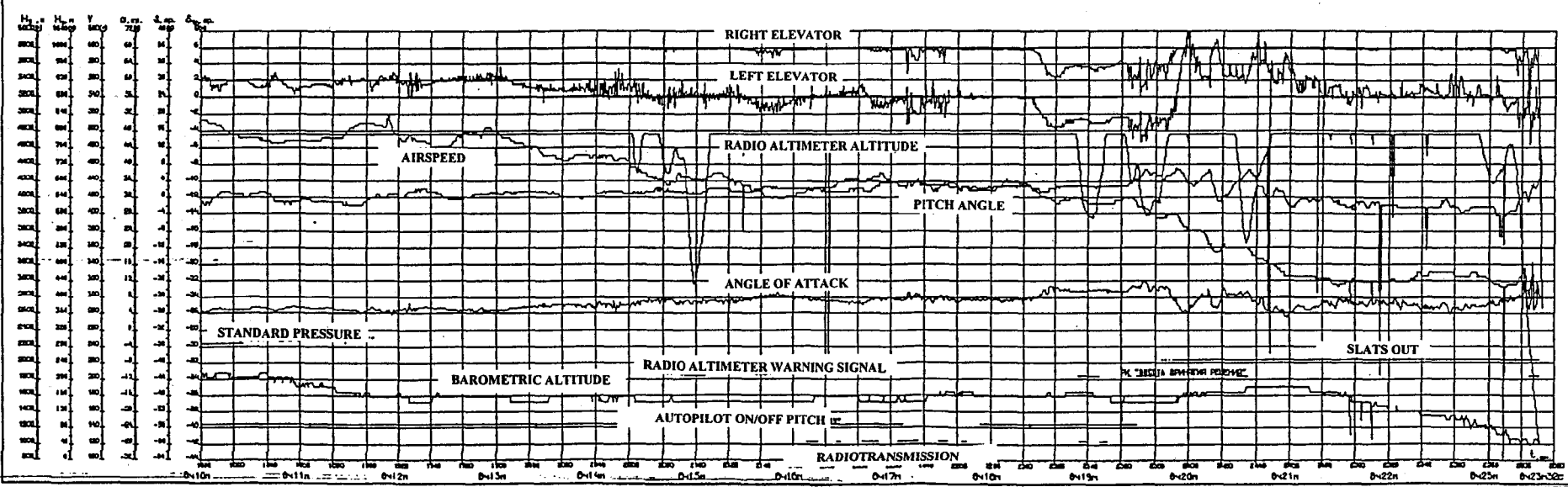
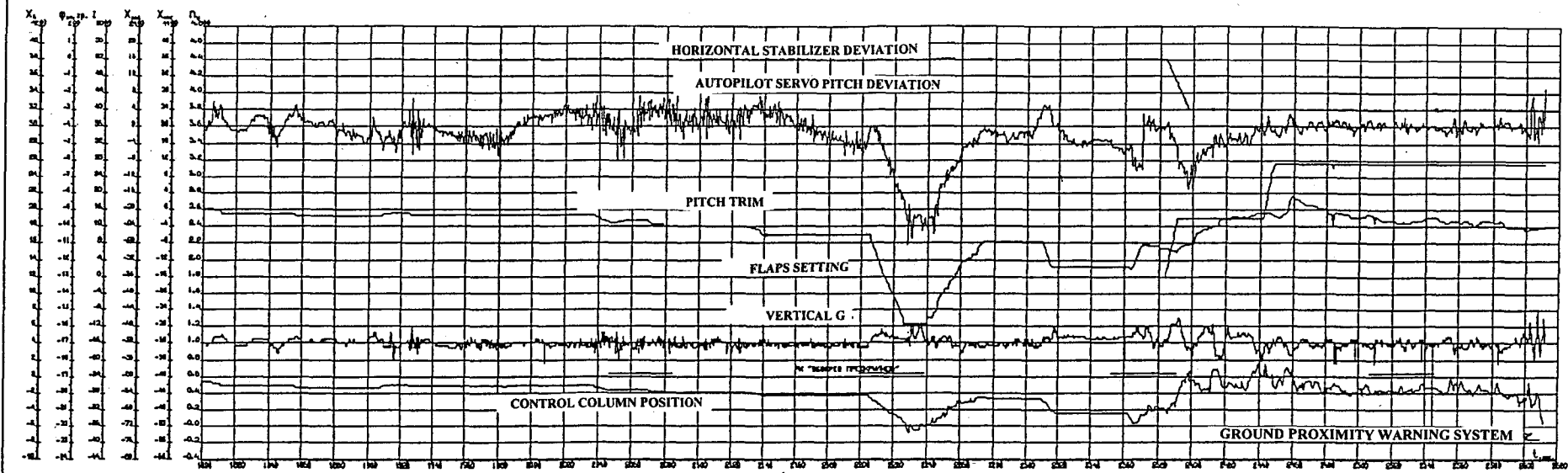

APPENDIX 5



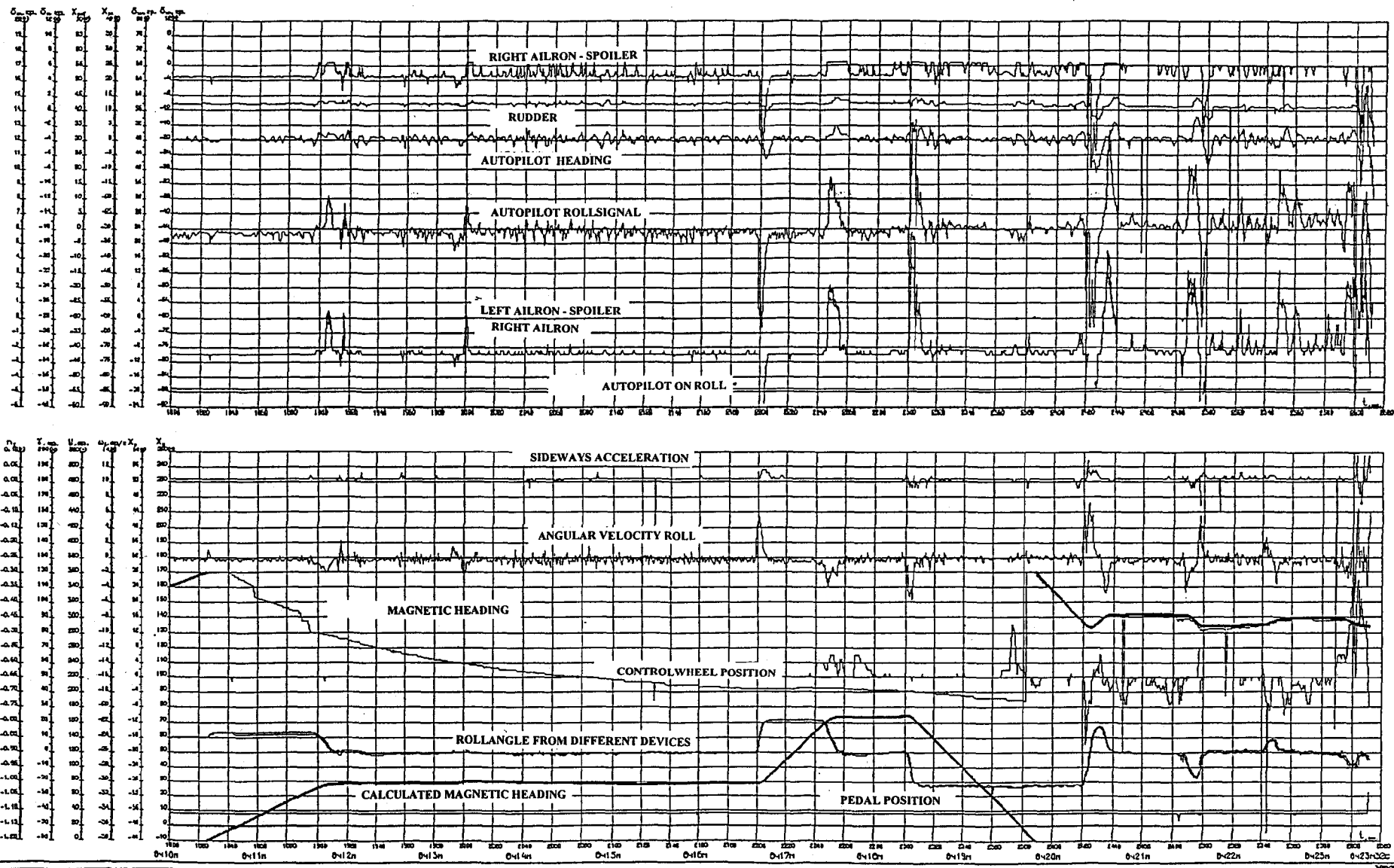
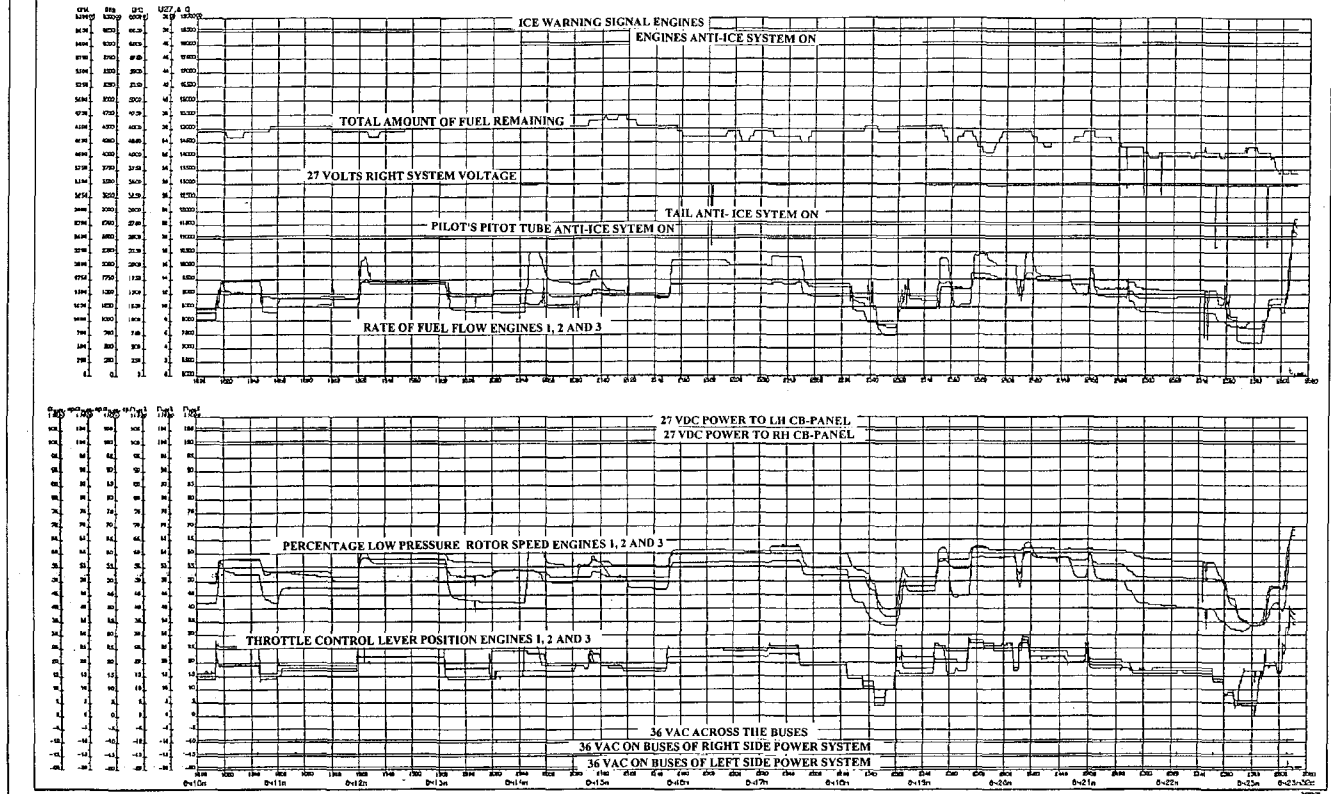
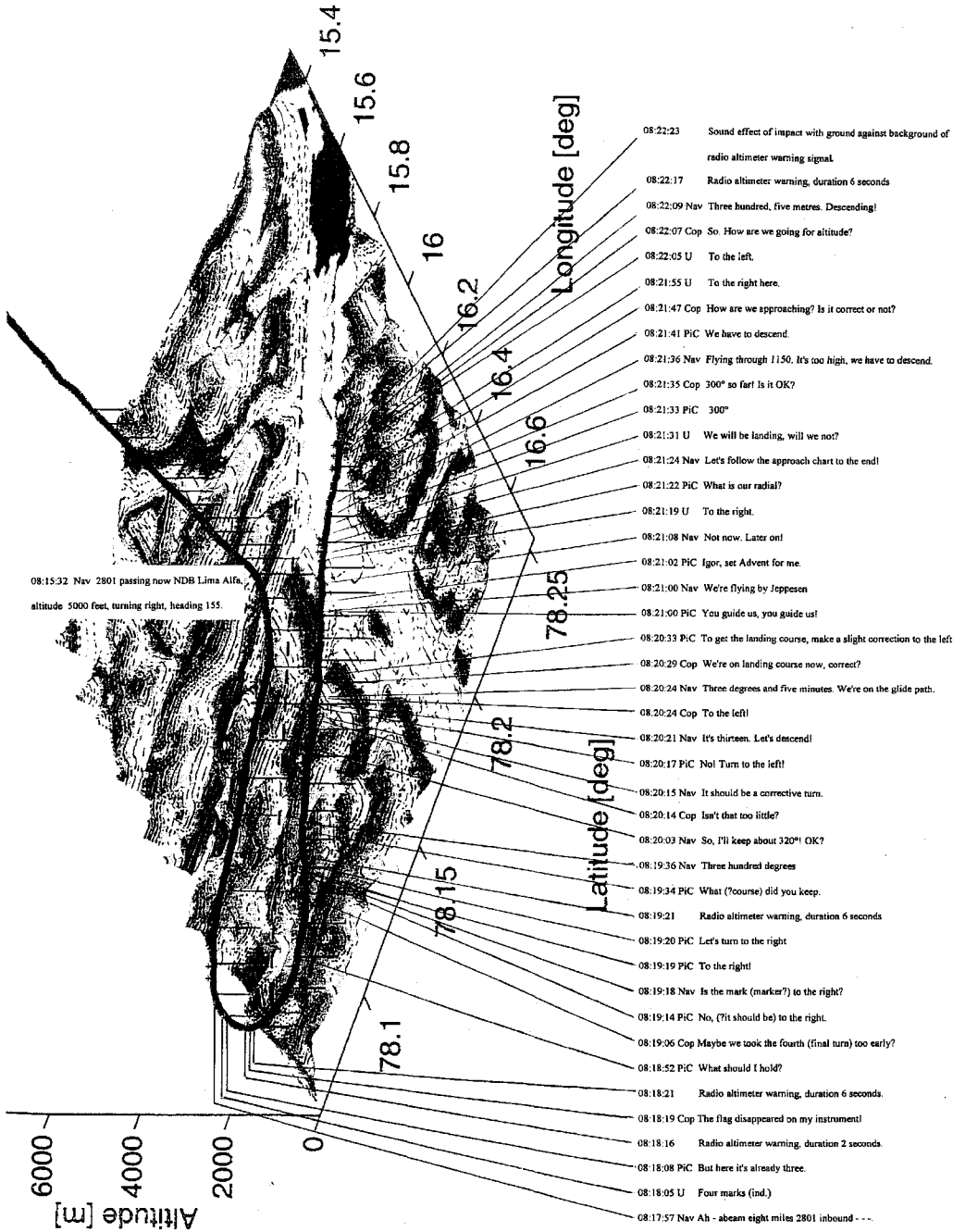

Vol. 23 No. 5

For Everyone Concerned with the Safety of Flight

September-October 1997

English-language Training For Air Traffic Controllers Must Go Beyond Basic ATC Vocabulary

Because miscommunication can have serious consequences, air traffic controllers responsible for international flights must have the skills in English to communicate more broadly than just to repeat learned phrases. The training and testing of controllers in English should require that controllers be able to respond to unusual, as well as routine, situations.

Shannon Uplinger
Uplinger Translation Services

In ordinary speech situations, we interpret spoken content by processing visual cues, such as gestures, and use these cues to supplement verbal information. As a last resort, we ask questions and obtain further information needed to make the meaning clear.

Context also plays an important role in understanding a speaker's message. Even if we miss a word or two of a speaker's presentation, we can still construct what the speaker said based on the usual context of the situation. Large amounts of spoken communication can be processed while we think about other things nearly simultaneously because context often makes much of the semantic content predictable.

Visual cues and contexts help make ordinary speech adequate for most of the things we do. Because pilots and air traffic controllers are invisible to one another they cannot depend on visual cues to facilitate communication. Furthermore, while communicating with each other, both pilots and controllers also process large amounts of visual information and perform other



linguistic tasks — pilots communicating with other crew members, controllers communicating with other flights and both groups monitoring their instruments.

Context can be misinterpreted. In pilot-air traffic control (ATC) radio communication, the term "two five zero" can be an altitude, an airspeed or a heading. Expecting, for example, to receive heading instructions from a controller, and perhaps hearing only the words "two five zero," a pilot might mistake an altitude clearance for a heading.

To compensate for distractions and the ambiguity of context, pilots and controllers use highly formatted exchanges and rely on readback to ensure that the intended meaning of their messages has been understood. Despite using readback, miscommunication can occur, especially when the listener's expectations influence what is heard.

In high-risk situations, such as those that can arise during ATC communication, the result of a miscommunication can be serious.

Steven Cushing presents examples of miscommunication that have caused or contributed to aviation accidents. In these accidents, visual, contextual and other redundant cues were unavailable, and the speakers failed to recognize or resolve the ambiguities in their exchanges.¹

Cushing cites the March 27, 1977, KLM Royal Dutch Airlines Boeing 747 collision with a Pan American World Airways B-747 in the Canary Islands, which resulted in 583 deaths; 61 survived. A pilot of the KLM aircraft said that he was "at takeoff," which the controller assumed to mean that the pilot was ready for takeoff and was awaiting further instructions. Actually, the KLM aircraft was taking off and was about to collide with the Pan American aircraft, which was taxiing on the runway toward the KLM aircraft.

Dealing with ambiguity in ATC communications is even more complex when flight crews, controllers or both are communicating in non-native English, that is, English that has been acquired as a second language.

The International Civil Aviation Organization (ICAO) does not mandate the use of English internationally for ATC communications, but recommends communication in the language "normally used by the station on the ground." Somewhat equivocally, ICAO recommends the use of English "pending the development and adoption of a more suitable form of speech for universal use in aeronautical radiotelephony communications."²

ICAO further recommends that English-language support should be available from ATC facilities serving designated routes and airports that are used by international flights. This ambiguous situation has resulted in *de facto* use of English as the international language of ATC without a requirement that it serve as such, and without the development of standards for training and testing controller use of English.

Given the challenges of ATC communication and the lack of regulatory specifications for English as the international language of aviation, it is not surprising that a number of aviation accidents have involved non-native English in pilot-controller communications. As Cushing noted concerning the accident in which the KLM pilot informed the controller that the B-747 was "at takeoff," the grammar of the pilot's native language, Dutch, interfered with his ability to construct the English statement "I am taking off," which would have had a different meaning to the controller.¹

Other accidents involving misinterpretation of meaning have occurred more recently. On Jan. 25, 1990, the first officer of an Avianca airliner failed to translate to the air traffic controller

the captain's statement that the aircraft was in an emergency situation, instead saying, "We're running out of fuel." The controller responded to a low-fuel situation, but not to a low-fuel emergency. The plane impacted terrain at Cove Neck, New York, U.S., killing 73 persons aboard the flight; 85 survived.

In December 1995, the American Airlines Flight 965 accident near Cali, Colombia, might have been prevented if the Colombian controller had been fluent in English.³ The Colombian government has officially determined flight crew error as the probable cause of the accident. Nevertheless, the Cali controller said that he did not have adequate English skills to ask questions when the crew made illogical statements about the plane's location. The Boeing 757 aircraft flew into a mountain and 160 were killed; four survived.

Problems arising from lack of fluency in English received considerable attention at a three-day Communicating for Safety Conference, sponsored by a number of major aviation professional groups, held May 15-17, 1997, near Phoenix, Arizona, U.S.

***Dealing with ambiguity
in ATC communications
is even more complex
when flight crews,
controllers or both are
communicating in
English that has been
acquired as a second
language.***

Speaking at the conference, Capt. John Cox of US Airways said, "Ours is a lexicon of abbreviations, acronyms and jargon, and just consider how many different versions of English we have. Often our language can be confusing — we have problems with oxymorons, slang, homonyms (to, too, two) and so forth."⁴

At the same conference, Frank Price, manager of Air Traffic International Staff of the U.S. Federal Aviation Administration (FAA), said, "Unlike [in] the past, international traffic is now flying into the [U.S.] heartland. Every [FAA Air Route Traffic Control] Center now works international traffic."⁴ Outside the United

States, air routes — such as those over Russia and China — that were severely restricted or prohibited from use by western air carriers during the Cold War have been opened, increasing the potential for pilot-ATC language problems.

At the special aviation safety conference convened by the U.S. Secretary of Transportation in early 1995 following several highly publicized accidents in the last five months of 1994, proposals were made to require all airline transport pilots to pass a test of English-speaking proficiency. This led to the drafting of a standardized test, which included three parts: written, listening and speaking, and using model airplanes to demonstrate understanding of flight-maneuver terminology. The FAA has reportedly not taken action to require such testing of non-U.S. pilots who fly to the United States, although one private company that teaches "aviation English" uses testing in its own proficiency assessments of non-U.S. pilots that it trains.⁵

At the recommendation of the U.S. National Transportation Safety Board (NTSB), the FAA in April 1997 sent ICAO a letter proposing the establishment of English standards, and ICAO is expected to respond before the end of 1997. The U.S. Congress has also expressed concern about the issue. In connection with appropriations for the FAA, the House of Representatives Transportation Appropriations Subcommittee urged the FAA to work with the NTSB and ICAO to standardize training and evaluation procedures for English proficiency in the worldwide aviation system and approved funding for such a program. A House-Senate conference committee has recently approved a US\$500,000 set-aside as part of the FAA budget for fiscal year 1998.

Several U.S.-based air carriers took the initiative to foster training of controllers, despite the absence of an international standard addressing skill levels. United Airlines, Northwest Airlines, Delta Air Lines, Alaska Airlines and FedEx supported English-proficiency programs for Russian and Chinese controllers at U.S. universities.⁵

Training programs to improve controller English skills face a variety of challenges. Because skill-level requirements have never been defined, training has emphasized mastery of standardized terminology. Nevertheless, the acquisition and use of language skill is complex and involves learning grammar, pronunciation, intonation and usage. Developing functionality in a foreign language is a difficult task.

Effective pilot-controller communication depends on the ability of the speakers to avoid ambiguity, at best, or at least to resolve ambiguous situations when they occur. If controllers lack adequate English skills, they cannot resolve ambiguous situations by requesting clarification or verification of details, as happened at Cali. Therefore, English proficiency needs to exceed the level required to reproduce memorized phrases and terms. The mastery of specialized terminology is insufficient.

Contrary to the method used in many countries, ATC terminology should be taught not to beginners, but only to students who have at least a relatively advanced knowledge of English. Jack C. Richards suggests that special terminology is best learned in the context of the general language in which it is used.⁶

ATC terminology is highly specialized and occurs infrequently in the general language, so mastery of ATC terminology alone does not produce functional proficiency in English. A fairly high level of functional proficiency is needed to master ATC terminology, because as Richards says, knowing a word includes:

- Knowing the probability of encountering that word in speech or print;

- For many words, knowing the type of words most likely to be associated with the word;
- Knowing the limitations imposed on the use of the word according to variations in function and situation; and,
- Knowing the syntax associated with the word.⁶

Knowledge of specialized terms is also easier to acquire when aspects of the language have been mastered first, such as principles of word formation and sentence structure. Teaching and testing knowledge of ATC terminology with lists of terms turns controllers into parrots, who are handicapped in unusual or stressful ATC situations, rather than skilled users of English who can apply the language in a range of contexts.

One solution to English-proficiency and other communication problems suggested by Cushing is an "intelligent voice interface," which would provide some callouts automatically; monitor voice transmissions for accuracy, completeness, plausibility and similar factors; and question the speaker as needed before transmitting communications. But, as Cushing acknowledges, we lack the technology and a complete understanding of how language is interpreted by the brain. For the present, he recommends development of other visual back-up systems to voice.

***If controllers lack
adequate English skills,
they cannot resolve
ambiguous situations by
requesting clarification
or verification of details.***

Although many advocate the use of datalink to avoid the complexities of voice communication, datalink might be a questionable replacement of voice communication for controlled approaches and other nonroutine situations. Reading and typing English language exchanges in free text, if required for datalink systems,

will be a time-consuming and challenging linguistic task for non-native speakers. Moreover, datalink and voice interface systems might discourage active monitoring of other flight crews' and controllers' voice communication, which often provides additional information. The resulting atrophy of verbal skills may impede the ability of controllers and pilots to respond to verbal information, especially when they are communicating in non-native English.

Although technical solutions have their appeal, the solution for the moment should be training that will give every pilot and controller the skills to serve as his or her own "intelligent voice interface." Technical systems should be used for back-up and augmentation, and should replace voice communication only for routine ATC exchanges.

For air traffic controllers, international English performance requirements need to be more clearly defined, and then re-evaluated as new technology is introduced that will change the use of natural language for communication between pilots and controllers. Because international standards have not been

developed, countries presently train and certify controllers according to their own standards, so different kinds of programs produce varying results.

For example, Russia and China, two countries training large numbers of controllers in English, face development of their own national standards for training and proficiency certification. In some Latin American countries, standards exist but should be reviewed. Without international policy and guidance, however, there is nothing to direct that various national standards should be similar.

Despite the lack of an international standard, Russian aviation authorities are working to develop the necessary standardization, testing and training programs to improve and maintain the English skill levels of Russian controllers. The same process may be used by other countries to establish local and eventually regional standardization, and these standards could ultimately provide the basis for a unified international standard for controllers' general English skills.

One of the first questions that Russian authorities have had to address is how much English air traffic controllers need to know. Here the Cali accident is instructive, because the controller's technical language proficiency was not adequate to meet the requirements of his job, although he was apparently fully trained. A controller who knows 200 or 300 English ATC terms may have very little functional ability to communicate in English, and therefore the requirement for general language skills must be defined clearly.

Results of surveys of U.S. flight crews who fly in Russia indicated that communication broke down most often when Russian controllers moved from strictly formatted exchanges to discuss weather, airport conditions and other topics that require skill in generating sentences. Some Russian textbooks introduce ATC language to controllers with only the most rudimentary English skills, or none at all,⁷ so it is not surprising that a Russian controller would know terminology in English but not have a wider command of the language.

As part of an initiative to measure Russian controller English proficiency and to design training to raise skill levels, Russian authorities have used standardized English testing to determine controllers' baseline scores. This process involves testing large numbers of controllers in different regions and observing controller performance to establish a minimum proficiency standard that can be applied to all controllers or selected groups of controllers based on job requirements.

This testing program, the first step toward development of a national standard, will enable the Russian authorities to identify weaknesses in training, select and prioritize personnel for training, measure the impact of training in terms of cost, and guarantee the capabilities of personnel to perform job duties using English.

This process will ensure that controllers can respond to a variety of nonroutine and emergency scenarios using English — for instance, to respond to questionable transmissions from the cockpit, to identify ambiguous situations and causes of ambiguity, and to provide the flight crews with appropriate instructions when these situations occur. In other words, job proficiency should provide a basis for the standard, and testing should be accomplished with respect to operational scenarios that a controller might encounter.

English courses that the Russian controllers attended in the past were primarily oriented toward development of conversational skills, because of the importance of speaking skills for job performance. Not surprisingly, Russian controller test scores have been higher for listening skills than reading skills.

Nevertheless, although speaking and listening skills might be used most by air traffic controllers, reading and writing skills must also be developed in training, even if to a lesser degree. For language learning, all these skills reinforce each other. Some controllers, for example, learn general and technical vocabularies best with visual reinforcement from reading and writing. To acquire general English proficiency as well as a knowledge of ATC applications, controllers must also acquire and use the full range of language skills.

Another language-training problem of special importance to Russia is attrition caused by lack of practice, which has its greatest influence on listening and speaking skills. Most people who have studied a foreign language are aware of how quickly skills are lost if not used regularly. For Russian controllers in particularly remote locations such as the Far East, the rarity of occasions to use English on the job may not be adequate to maintain their skills, and soon proficiency becomes reduced.

The English training program in these parts of Russia, like programs in other countries where English use is limited, will need to include mechanisms such as regular testing to identify skill attrition, with maintenance and refresher programs to counteract attrition. The value of costly training for controllers is lost when language skills atrophy and the training system does not respond by restoring proficiencies.

Communication broke down most often when Russian controllers moved from strictly formatted exchanges to discuss weather, airport conditions and other topics that require skill in generating sentences.

Examples from Russia show that the English problem is not easy to solve, but that the problem is solvable. Large-scale baseline testing is planned, as is the development of standards, training and testing to produce, measure, maintain and certify language skills. Such a comprehensive and systematic approach will provide the basis for a program that can be easily managed and evaluated for cost-effectiveness.

Even the best-managed English training will not eliminate inherent ambiguities in language, and such training will not compensate for poor discipline, fatigue and other problems in the workplace. But training will improve the ability of air traffic controllers to perform their jobs and greatly reduce the risk that controllers and pilots will communicate with, but not understand, one another.

Like the controllers and pilots who use English language for ATC communications, the aviation industry needs to be more aware of language issues so that it can design training systems to produce and maintain the necessary language skills.

This will ensure that English training will be provided to controllers as thoroughly and systematically as the other training that they receive, and that continued international use of English for pilot-controller communications will support, rather than undermine, the safety of flight. ♦

References

1. Cushing, S. "Pilot-Air Traffic Control Communications: It's Not (Only) What You Say, It's How You Say It." *Flight Safety Digest* Volume 14 (July 1995).
2. International Civil Aviation Organization (ICAO). Annex 10 — Aeronautical Telecommunications, Volume II, "Communication Procedures," paragraphs 5.2.1.1.1 and 5.2.1.1.2. Montreal, Quebec, Canada: ICAO, 1995.
3. Phillips, D. "Pilots' Confusion Revealed in Tapes from Cali Crash." *The Washington Post*, April 17, 1996. Phillips wrote: "The Cali air traffic controller handling the flight told investigators that he realized that the crew's replies to some of the instructions 'made no sense' and were 'illogical,' but he lacked proficiency in colloquial English to confront the crew. So he merely repeated his instructions, never believing the plane was in danger ... [The controller] said that he spoke good 'technical' English necessary for international air traffic control, [but that] ... his language capabilities did not allow him to ask questions of the crew then or when they began asking for a new route that confused him."
4. Steenblik, J.W. "Communicating for Safety." *Air Line Pilot* Volume 66 (September 1997).
5. Nordwall, B.D. "FAA: English ATC Standards Needed." *Aviation Week & Space Technology* Volume 147 (Sept. 29, 1997).
6. Richards, Jack C. *The Context of Language Teaching*. Cambridge, England: Cambridge University Press, 1985.
7. For example, *Uchebnik anglijskogo yazyka dlya letnogo I dispetcherskogo sostava mezhdunarodnykh avialinij*, Moskva, Voennoe izdatel'stvo Ministerstva oborony SSSR, 1972. This textbook for Russian air traffic controllers introduces English pronunciation in the same initial chapters that contain aviation vocabulary such as "airplane," "map," "flight plan," "apron" and "to taxi." It is intended for use in a 300-hour course to prepare controllers to be certified to provide air traffic control in English.

About the Author

Shannon Uplinger is president of Uplinger Translation Services, which provides translation, interpretation and glossary support to aviation firms with activities in Russia. She previously served as a training manager for the U.S. Air Force, where she was responsible for management of language programs. She has a B.A. degree in Russian language and literature and an M.A. degree in Russian and Eastern European studies. Uplinger is a recipient of the Commandant's Award in Russian from the Defense Language Institute.

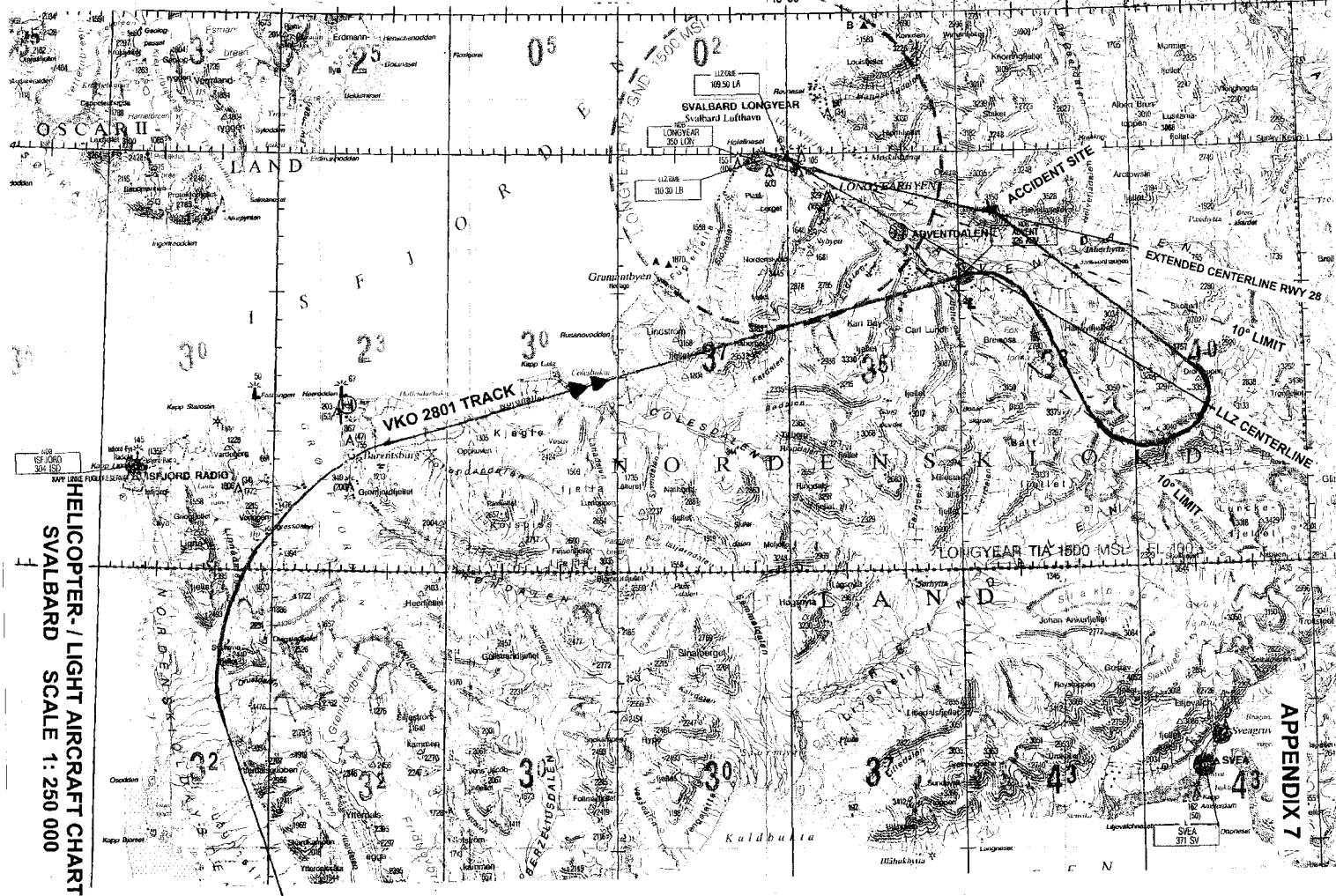

HELICOPTER-/LIGHT AIRCRAFT CHART
SVALBARD SCALE 1:250 000

APPENDIX 7

ISF 260
304 ISD

SVEA
311 SV

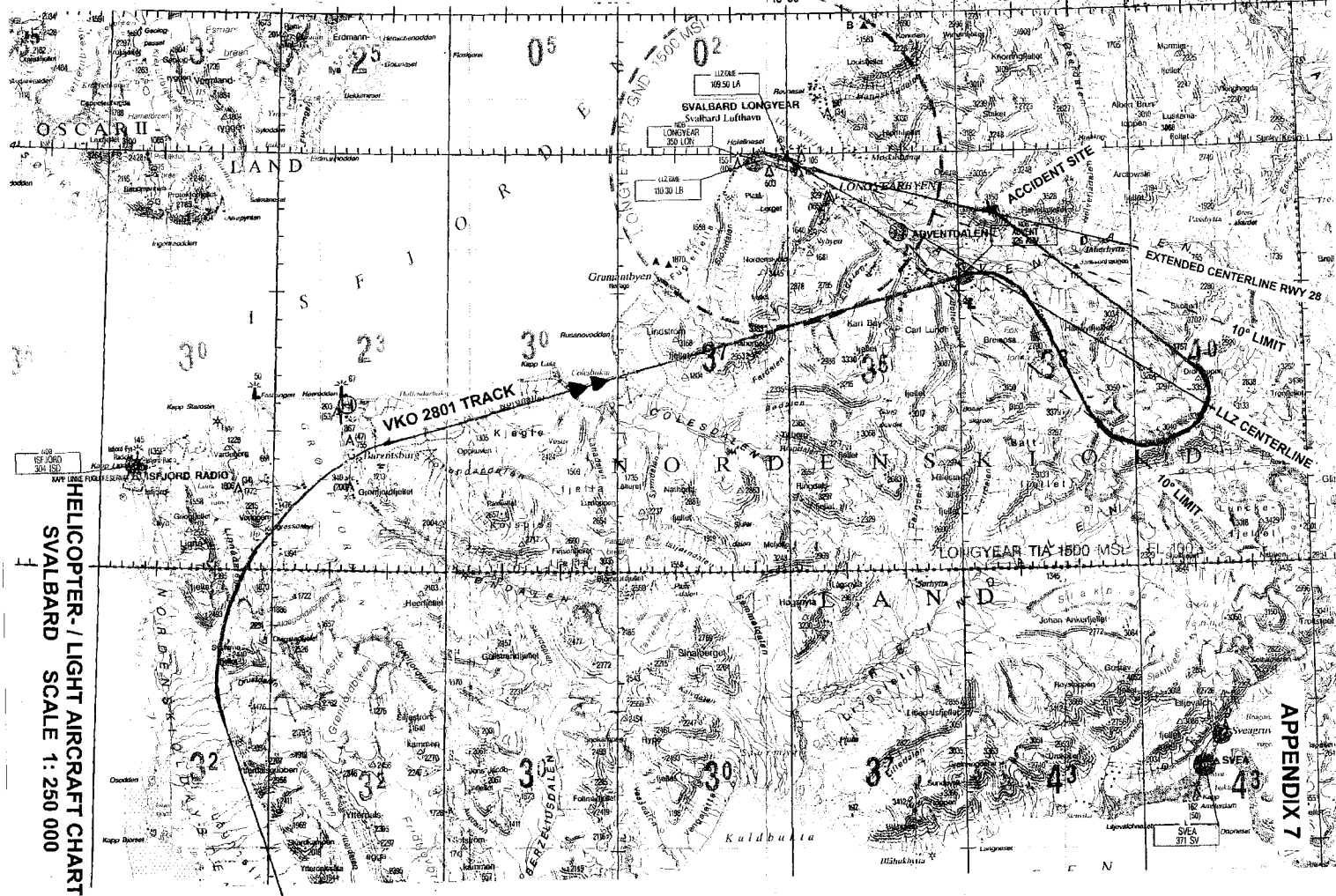

APPENDIX 8

ABBREVIATIONS

AAIB/N	Aircraft Accident Investigation Board/ Norway
ACC	Area Control Centre
ADF	Automatic Direction Finding
ADV	Advent
AFCS	Automatic Flight Control System
AFIS	Aerodrome Flight Information Service
AIP	Aerodrome Information Publication
ASGAA	Allied Signal General Aviation Avionics
ATC	Air Traffic Control
ATCC	Air Traffic Control Centre
ATS	Air Traffic Service
AUTO	Automatic
BJO	Bjørnøya
BKN	Broken
CAT	Category
CDI	Course Deviation Indicator
COM	Communication
CVR	Cockpit Voice Recorder
DME	Distance Measuring Equipment
E	East
FDR	Flight Data Recorder
FIR	Flight Information Region
FIS	Flight Inspection Section
FM	Flight Manual
ft	feet
GPS	Global Positioning System
GPWS	Ground Proximity Warning System
hPa	hecto Pascal
hrs	hours
HSI	Horizontal Situation Indicator
IAC	Interstate Aviation Committee
IAP	Instrument Approach Procedure
ICAO	International Civil Aviation Organization
ILS	Instrument Landing System
IMC	Instrument Meteorological Conditions
ISD	Isfjord
JAN	January
km	kilometer
kN	kilo Newton
kt	knot
LLZ	Localizer

LON	Longyear
LP	Low Pressure
MAN	Manual
MHz	Mega Hertz
N	North
NAV	Navigation
NCAA	Norwegian Civil Aviation Administration
NDB	Non-Directional Beacon
NM	Nautical Miles
NOSIG	No significant change
nT	nano Tesla
OBS	Omni Bearing Selector
OCA	Oceanic Control Area
PAPI	Precision Approach Path Indicator
PIC	Pilot-in-Command
Prob	Probability
QDM	Magnetic heading ('to the station')
QFE	Atmospheric pressure at airport elevation
QNH	Altimeter sub-scale setting to obtain elevation when on the ground
RAC	Rules of the air and air traffic services
RADZ	Rain and Drizzle
RESH	Recent Shower
RFCAA	Russian Federation Civil Aviation Administration
RMI	Radio Magnetic Indicator
SCT	Scattered
SHRA	Rain shower
STEP	Sequentially Timed Events Plotting
SV	Svea
TEMPO	Temporary
TIA	Traffic Information Area
TIZ	Traffic Information Zone
TU	Tupolev
UTC	Universal Time Coordinated
V	Volt
VHF	Very High Frequency
VDF	VHF Direction Finding
VKO	Vnukovo
VOR	VHF Omnidirectional Receiver
VRB	Variable